

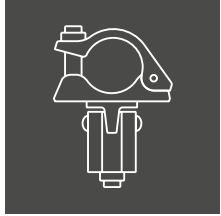

MJ-GERÜST
Scaffolding Systems

WWW.MJ-SCAFFOLDING.COM     



ACCESSORIES

PRICES | EDITION 04.2025



**SCAFFOLDING MADE IN
PLETTENBERG**

SCAFFOLDINGS MADE IN PLETTENBERG

MJ-Gerüst GmbH, based in Plettenberg in the German region of Sauerland, is part of a strong group of companies, which can look back on more than 50 years of company history. The core competence of the family company lies in the production and worldwide distribution of high-quality steel and aluminum scaffolding systems, which offer almost limitless possibilities in the field of modern system scaffolding construction.

With a unique range of products and a wide range of universal accessories, we offer our customers the option of completing existing scaffolding material in a system-compatible complement. A highly valued advantage by our customers that has given our scaffolding international recognition and prominence.

Development, production and sales. These are the cornerstones of our range of services, which are supplemented by numerous additional services. Especially our support in the planning and implementation of difficult projects is claimed. A service in which our technical know-how and experience can often contribute to considerable time and cost savings.

Only through qualified work can a safe quality product be created. Our proven quality management reflects our knowledge and experience and makes the quality of our products measurable. In order to guarantee our high quality standards, our production processes are constantly accompanied by external examination offices and engineers.



OUR COMPANY - YOUR BENEFITS

- Production in Germany at the location Plettenberg
- System compatible, high quality and norm compliant scaffold systems
- Certifications according to DIN EN 9001, 14001 and 50001
- Highest product quality through dynamic quality management
- Short-term availability of material due to high storage capacities and short decision-making processes
- Use of the modern production technology and permanent optimization of technological production running
- Project support already in the planning phase

PARTNER AND CERTIFICATES



BUNDESINNING
GERÜSTBAU

MPA NRW



SGUV
SESE
SISP
Schweizerischer Gerüstbau-Unternehmer-Verband
Société des Entrepreneurs Suisse en Echafaudages
Società degli Imprenditori Svizzera dei Ponteggi

Deutsches
Institut
für
Bautechnik

DIBt





WWW.MJ-SCAFFOLDING.COM



Base jacks	04
Tubes and support	08
Couplers	11
Deck fastening / Couplers	19
Anchoring	20
Lattice beams	23
Bridging	28
The safety enclosure OPTI-BOARD	30
Protection wall / Barrier	33
Roof components	35
Nets and tarpaulins	39
Ladders	43
Storage and transport	45
Repair accessories	48
Tools	53
Advertising technic	55
Securing during assembly of the scaffold	56

 Made in Plettenberg

 General building approval

 European standard

 Individual identification

 Net price, not discountable

 Approval procedure not yet completed

 Delivery time on request

All prices exclude VAT applicable at the time of shipment. All dimensions and weights are non-binding approximate values. Technical data is subject to change without prior notice. Prices are charged as applicable on the day of shipment. Sale is subject exclusively to our sales terms and delivery conditions. An excerpt: place of business and jurisdiction is Plettenberg. Extended retention of title until full payment of all outstanding claims. Our prices are ex works.

UNDERLAY WOODS

- As a load distributing support
- Sawn
- Dimension +/- 10 mm



Length (m)	Width (m)	Height (m)	Weight (kg)	PU (pcs.)	Article no.	Price (€)
1,00	0,24	0,04	1,50	80	009203	10,20
1,50	0,24	0,04	2,25	80	010360	12,30

PROTECTIVE PAD FOR BASE JACK

- Plastic
- With reflector

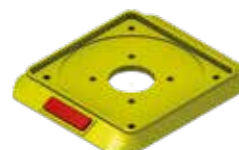

PU (pcs.)	Article no.	Price (€)
80	008110	4,40

RUBBER PAD FOR BASE JACK

- Made from recycled cable material
- Oil and acid resistant
- Stackable (015339)



Height (m)	Width (m)	Weight (kg)	PU (pcs.)	Article no.	Price (€)
0,03	0,24	1,60	450	015338	15,10
0,03	0,24	1,50	450	015339	15,10

BASE JACK

Z EN

- Steel, hot dip galvanized
- With tube spindle
- Base plate 150 x 150 mm
- For adjusting level with differences in height of the underground
- Knurled nut with collar for centring the shaft on the spindle
- Lock to prevent unscrewing of the knurled nut and to ensure the necessary bridging length
- Can be used as a head spindle

Length (m)	Weight (kg)	PU (pcs.)	Article no.	Price (€)
0,30	2,40	375	000318	17,80
0,50	3,10	300	000319	21,30
0,60	3,40	300	000320	22,00
0,78	3,90	250	000321	29,80
1,00	4,70	200	000322	35,70



SWIVEL BASE JACK

EN

- Steel, hot dip galvanized
- With tube spindle
- Swiveling base plate 150 x 150 mm
- For adjusting level with differences in height of the underground
- Knurled nut with collar for centring the shaft on the spindle
- Lock to prevent unscrewing of the knurled nut and to ensure the necessary bridging length
- Can be used as a head spindle
- Additional longitudinal scaffold bracing required at in the base
- Permissible load: 25.4 kN

Length (m)	Weight (kg)	PU (pcs.)	Article no.	Price (€)
0,50	3,10	250	000323	46,30
0,80	4,30	200	013292	54,50



BASE JACK SOLID

EN

- Steel, hot dip galvanized
- Base plate 150 x 150 mm
- For adjusting level with differences in height of the underground
- Knurled nut with collar for centring the shaft on the spindle
- Can be used as a head spindle
- Without stoppers
- Permissible load: $N_{pL,Rd} = 197 \text{ kN}$. $M_{pL,Rd} = 105 \text{ kNm}$. $V_{pL,Rd} = 85.2 \text{ kN}$

Length (m)	Weight (kg)	PU (pcs.)	Article no.	Price (€)
0,60	6,70	200	007095	47,50



SPINDLE SECURITY 

- Steel, hot dip galvanized
- With half coupler
- Serves for securing spindle and castor with spindle when moving a scaffold with a crane

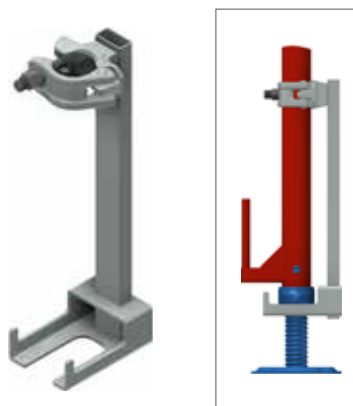

Height (m)	Weight (kg)	A/F	PU (pcs.)	Article no.	Price (€)
0,40	2,00	19	200	010294	30,20 

CASTOR WITH SPINDLE 

- Bearing 10 kN with central load distribution
- Castor Ø 200 mm made of polyamide with run stop
- Levelling through adjustable steel spindle
- The DIN 4420-3 applies when a rolling towers made of a scaffolding
- A standard proof of stability is required for this mobile scaffold



Weight (kg)	PU (pcs.)	Article no.	Price (€)
7,00	80	000332	102,50

CASTOR WITH SPINDLE 

- Electrically conductive and antistatic
- Bearing 10 kN with central load distribution
- Castor Ø 200 mm made of polyamide with run stop
- Levelling through adjustable steel spindle
- The DIN 4420-3 applies when a rolling towers made of a scaffolding
- A standard proof of stability is required for this mobile scaffold



Weight (kg)	PU (pcs.)	Article no.	Price (€)
7,00	80	015925	169,90

ADJUSTMENT TUBE



- Steel, hot dip galvanized
- Adjustment range 10 x 0.10 m = 1.00 m
- For levelling unequal ground
- Use in connection with a decking transom and base jack

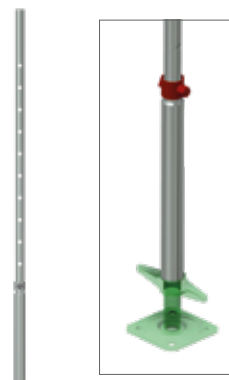

Height (m)	Weight (kg)	Article no.	Price (€)
1,70	5,80	000402	56,70

HEAD JACK

- Steel, hot dip galvanized
- Supporting element for support and platform scaffolding as well as for formwork scaffolds
- Used to hold squares timbers, laminated beams and formwork beams



Opening dimension (mm)	Weight (kg)	PU (pcs.)	Article no.	Price (€)
148	5,60	200	000693	40,60
180	8,30	-	011537	49,90

CROSSHEAD SPINDLE SOLID

EN

- Steel, hot dip galvanized
- Supporting element for support and platform scaffolding as well as for formwork scaffolds
- Used to hold squares timbers, laminated beams and formwork beams



Opening dimension (mm)	Weight (kg)	Article no.	Price (€)
85/165	6,93	014284	91,80

SCAFFOLD TUBE STEEL EN

- S235 Steel, hot dip galvanized
- Measurements as per DIN 4427/EN
- Manufacturing length 6.00 m
- Minimum yield strength 235 N/mm²
- Connection of standard couplers allowed
- Special lengths on request

Model (mm)	Length (m)	Weight (kg)	PU (pcs.)	Article no.	Price (€)
48,3 x 4,0	1,00	4,20	61	000342	20,50
48,3 x 4,0	2,00	8,40	61	000341	38,00
48,3 x 4,0	3,00	12,60	61	000339	55,50
48,3 x 4,0	4,00	16,80	61	000345	75,00
48,3 x 4,0	5,00	21,00	61	000338	92,50
48,3 x 4,0	6,00	25,20	61	000334	105,00
48,3 x 3,2	1,00	3,77	61	004548	17,20
48,3 x 3,2	2,00	7,54	61	004550	31,40
48,3 x 3,2	3,00	11,31	61	004552	45,60
48,3 x 3,2	4,00	15,08	61	004554	61,80
48,3 x 3,2	5,00	18,85	61	005619	76,00
48,3 x 3,2	6,00	22,60	61	004087	85,00

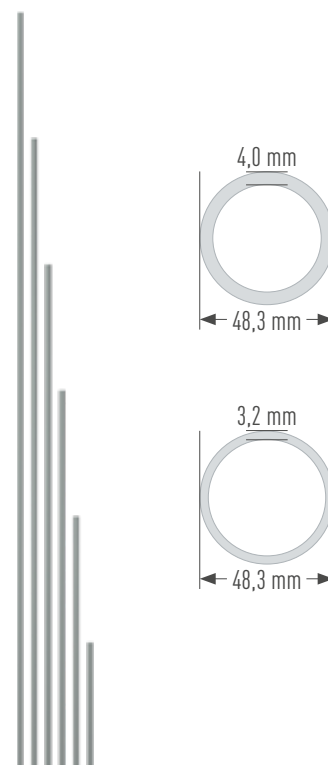

SCAFFOLD TUBE ALUMINUM DE EN

- Aluminum alloy EN AW-6082 T6
- Dimensions according to DIN 1725/1748
- Manufacturing length 8.00 m
- Yield strength of 240 ≥ N/mm²
- Connection of standard couplers permitted
- For light scaffold constructions
- Special lengths on request

Model (mm)	Length(m)	Weight (kg)	Article no.	Price (€)
48,3 x 4,0	1,00	1,50	000353	18,50
48,3 x 4,0	2,00	2,80	000352	39,80
48,3 x 4,0	3,00	4,20	000350	57,70
48,3 x 4,0	4,00	5,60	000349	75,60
48,3 x 4,0	5,00	7,00	000354	91,00
48,3 x 4,0	6,00	8,40	002028	111,40
48,3 x 4,0	8,00	11,20	002031	143,00

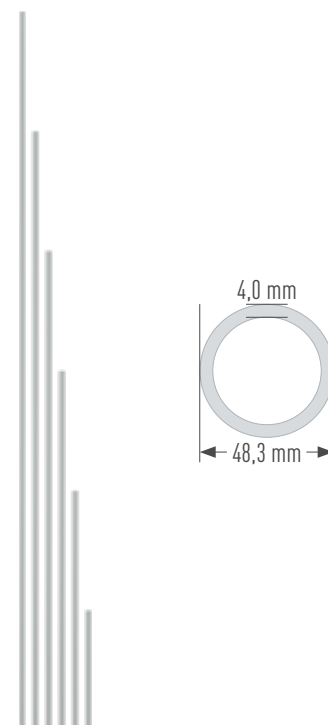

TRIANGULAR BRACE SUPPORT



- Steel tube \varnothing 48.3 mm, hot dip galvanized
- With perforation
- Three scaffold tubes connected in triangular form
- Brace for carrying large loads
- Distance between tubes 125 mm

Length (m)	Weight (kg)	Article no.	Price (€)	
3,00	40,00	000150	294,90	🕒
4,00	53,00	000151	363,00	🕒
5,00	65,00	000152	479,10	🕒
6,00	75,00	000153	561,70	🕒



BASE PLATE FOR TRIANGULAR BRACE



- Steel, hot dip galvanized
- Plate 300 x 8 mm
- With three welded tube studs to carry the load



Weight (kg)	Article no.	Price (€)
6,00	000155	67,70

PROTECTIVE CAP HARD PLASTIC

- Hard plastic
- For tubes \varnothing 48.3 mm
- Yellow



Weight (kg)	Article no.	Price (€)
0,03	009773	4,30

PROTECTIVE CAP PLASTIC

- Plastic
- For tubes Ø 48.3 mm
- Red



Weight (kg)	Article no.	Price (€)
0,011	006784	4,30

RIBBED PLUG

- Polyethylene
- For tubes Ø 48.3 mm
- Black



Weight (kg)	Article no.	Price (€)
0,01	010219	4,30

TUBE PROTECTION

- Protective cap for tubes Ø 48.3 mm
- With one or two reflectors



Model	Weight (kg)	Article no.	Price (€)
One-piece	0,10	011281	3,60
Two-piece	0,15	011282	3,80

STANDARD COUPLER

EN

- Steel, hot dip galvanized, drop-forged
- Robust model
- For right-angled connection of tubes \varnothing 48.3 mm
- Class BB, EN 74-1 RA BB C3 M
- To be used in the classes B and BB of the steel and aluminum tube

Thread	A/F	Weight (kg)	PU (pcs.)	Article no.	Price (€)
Normal	22	1,15	25	000325	8,60
Normal	19	1,15	25	000326	8,60
Quick	22	1,15	25	007521	9,30
Quick	19	1,15	25	007523	9,30



SWIVEL COUPLER

EN

- Steel, hot dip galvanized, drop-forged
- Robust Model
- For any angular connection of tubes \varnothing 48.3 mm
- Class B, EN 74-1 SW B C3 M
- To be used in class B of the steel and aluminum tube

Thread	A/F	Weight (kg)	PU (pcs.)	Article no.	Price (€)
Normal	22	1,35	25	000328	9,30
Normal	19	1,35	25	000329	9,30
Quick	22	1,35	25	007522	9,90
Quick	19	1,35	25	007524	9,90



HEXAGON COLLAR NUT

EN

- Thread M 14
- Strength class 5 as per EN 20898-2

Thread	A/F	Weight (kg)	PU (pcs.)	Article no.	Price (€)
Standard	22	0,04	500	000165	0,40
Standard	19	0,03	500	000166	0,40
Quick	22	0,04	500	005105	0,50
Quick	19	0,03	500	006547	0,50



T-HEAD BOLT

EN

- Thread M 14
- Shaft length approx 68 mm
- Strength class 5.8 as per DIN EN ISO 898

Thread	Weight (kg)	PU (pcs.)	Article no.	Price (€)
Normal	0,11	200	000164	0,65
Quick	0,11	200	005104	0,77



SLEEVE COUPLER

EN

- Steel, hot dip galvanized, drop-forged
- Robust model, ribbed
- Coupling class B, EN 74-1 SF B C3 M
- For connecting two steel or aluminum tubes \varnothing 48.3 mm in one axis
(only in conjunction with tube connector type article no. 000331)



A/F	Weight (kg)	Article no.	Price (€)
22	1,80	000330	13,00
19	1,75	003061	13,00

TUBE-CONNECTOR

EN

- Steel, hot dip galvanized, drop-forged
- For scaffold tubes \varnothing 48.3 mm
- For the manufacture of tensile-resistant and pressure-resistant butt joints



Weight (kg)	Article no.	Price (€)
1,00	000331	8,40

BASIC COUPLER



- T-carrier plate with two parallel welded half couplers
- To bear vertical loads of scaffold constructions
- To be mounted directly on the facade
- Holes in the T-carrier plate for the use of M12 screws
- Basic structural analysis available
- Extensive lattice beam constructions are no longer necessary



A/F	Weight (kg)	Article no.	Price (€)
22	3,60	003247	48,90
19	3,60	004591	48,90

BASIC COUPLER ADJUSTABLE



- T-carrier plate with two parallel welded half couplers
- To bear vertical loads of scaffold constructions
- To be mounted directly on the facade
- Holes in the T-carrier plate for the use of M12 screws
- Basic structural analysis available
- Extensive lattice beam constructions are no longer necessary
- Adjustable for wall distances from 148 - 205 mm
- With four fixing holes

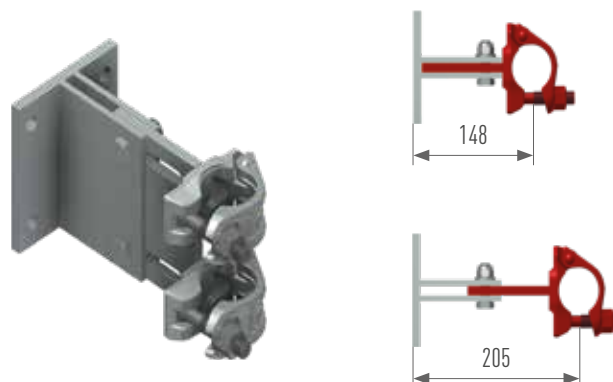

A/F	Weight (kg)	Article no.	Price (€)
22	5,00	009137	70,40

GUARD RAIL COUPLER



- Steel, hot dip galvanized
- With half coupler
- Attachment for attaching additional back guard rails, e. g. on the inside of the scaffolding



Thread	A/F	Weight (kg)	PU (pcs.)	Article no.	Price (€)
Standard	22	1,20	25	002464	20,60
Standard	19	1,20	25	000591	20,60

GUARD RAIL COUPLER WITH WEDGE

- Steel, hot dip galvanized
- With half coupler
- With wedge lock



Weight (kg)	Article no.	Price (€)
1,30	003550	21,30

SWIVEL PIN COUPLER

Z EN

- Steel, hot dip galvanized, drop-forged
- Half coupler with welded swivel pin for attaching additional back guard rails, e. g. on the inside of the scaffolding

Thread	A/F	Weight (kg)	Article no.	Price (€)
Standard	22	0,80	000134	9,90
Standard	19	0,80	002354	9,90



TOE BOARD COUPLER

EN

- Steel, hot dip galvanized, drop-forged
- Half coupler with welded toe board bracket

Thread	A/F	Weight (kg)	Article no.	Price (€)
Standard	22	1,00	000647	17,70
Standard	19	1,00	002711	17,70



BOLT-ON COUPLER

EN

- Steel, hot dip galvanized, drop-forged
- Half coupler with welded machine screw M 14 x 50 mm

Thread	A/F	Weight (kg)	Article no.	Price (€)
Standard	22	0,80	000136	11,50



COMBINATION COUPLER

EN

- Steel, hot dip galvanized, drop-forged
- Half coupler with welded on machine screw M 14 x 120 mm
- For connecting scaffold tubes to timber components

Thread	A/F	Weight (kg)	Article no.	Price (€)
Standard	22	1,00	000392	17,90



HOOK COUPLER

EN

- Steel, hot dip galvanized, drop-forged
- Half coupler with welded stiffening hook
- For larger wall distances, the ideal solution for scaffold fastening



A/F	Weight (kg)	Article no.	Price (€)
22	1,00	000224	17,70
19	1,00	002551	17,70

CLAW COUPLER



EN

- Steel, hot dip galvanized, drop-forged
- Half coupler with welded steel angle
- For hanging scaffold tubes or chains to steel constructions
- 9 kN (900 kg) permissible weight
- To be used in pairs



A/F	Weight (kg)	Article no.	Price (€)
22	1,00	000225	14,70
19	1,00	000226	14,70

SQUARED TIMBER COUPLER



EN

- Steel, hot dip galvanized, drop-forged
- Half coupler with perforated iron angle for mounting squared timber
- Swivel coupler



A/F	Weight (kg)	Article no.	Price (€)
22	1,80	000631	28,80
19	1,80	002704	28,80

WEDGE HEAD COUPLER FIXED

EN

- Steel, hot dip galvanized, drop-forged
- With screw cap
- For connection of scaffolding tubes to the perforated disc



A/F	Weight (kg)	PU (pcs.)	Article no.	Price (€)
22	1,10	25	005859	25,70
19	1,10	25	005858	25,70

WEDGE HEAD COUPLER FIXED PARALLEL

EN

- Steel, hot dip galvanized, drop-forged
- For connection of scaffold tubes to the perforated disc



A/F	Weight (kg)	PU (pcs.)	Article no.	Price (€)
19	1,10	25	009947	24,20
22	1,10	25	009948	24,20

SWIVEL WEDGE HEAD COUPLER

EN

- Steel, hot dip galvanized, drop-forged
- With screw cap
- For connection of scaffolding tubes to the perforated disc



A/F	Weight (kg)	PU (pcs.)	Article no.	Price (€)
22	1,20	25	005861	28,90
19	1,20	25	005860	28,90

PEFORATED DISC CLAMPABLE

Z

- Ensures the possibility of mounting at the desired position along a standards or tubes \varnothing 48.3 mm



A/F	Weight (kg)	PU (pcs.)	Article no.	Price (€)
22	0,95	25	002229	36,70
19	0,95	25	004587	36,70

REDUCING BASIC COUPLER

EN

- Steel, hot dip galvanized, drop-forged
- For connection tubes with different outer diameter
- Included t-head bolt and collar nut



Combination	A/F	Weight (kg)	Article no.	Price (€)
48/38	19	1,20	000327	16,40
48/38	22	1,20	010022	16,40
48/60	19	1,80	010818	19,40
48/60	22	1,80	002820	19,40
48/34	19	1,20	010819	16,20
48/34	22	1,20	006061	16,20

REDUCING SWIVEL COUPLER

EN

- Steel, hot dip galvanized, drop-forged
- For connection tubes with different outer diameter
- Included t-head bolt and collar nut



Combination	A/F	Weight (kg)	Article no.	Price (€)
38/38	22	1,81	004494	13,60
48/38	19	1,00	006198	14,40
48/38	22	1,00	000383	14,40
48/60	19	1,58	010821	15,40
48/60	22	1,58	000384	15,40
48/34	19	1,00	010822	14,60
48/34	22	1,00	000386	14,60

HALF COUPLER

EN

- Steel, hot dip galvanized, drop-forged
- With screw cap



A/F	Weight (kg)	Article no.	Price (€)
22	0,70	001773	6,60
19	0,70	000628	6,60

DECK FASTENING WITH WEDGE



- Steel, hot dip galvanized
- For preventing decks from lifting off
- With wedge head connection



Weight (kg)	Article no.	Price (€)
0,70	006850	14,60

DECK FASTENING WITH HALF COUPLER



- Steel, hot dip galvanized, drop-forged
- For securing decks against lifting off



A/F	Weight (kg)	Article no.	Price (€)
19	1,10	008156	15,80
22	1,15	008157	15,80

DECK FASTENING



- Steel, hot dip galvanized
- For securing decks from lifting off



A/F	Width (m)	Weight (kg)	Article no.	Price (€)
19	0,40	1,50	007302	26,60

DECK FASTENING DOUBLE



- Steel, hot dip galvanized
- For securing decks and gap covers from lifting off



A/F	Weight (kg)	Article no.	Price (€)
22	1,00	009240	18,90

DISTANCE COUPLER



- Steel tube \varnothing 48.3 mm
- With two welded couplers, galvanized
- E. g. as connection between facade scaffold and a forward-placed stair ascent

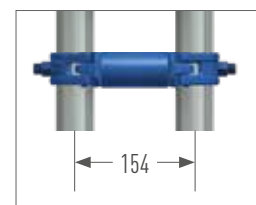

Width (m)	A/F	Weight (kg)	Article no.	Price (€)
0,110	22	1,60	008225	26,00
0,114	22	1,80	004758	41,00
0,154	19	1,80	008297	26,30
0,180	22	2,00	000233	27,10

WALL TIE  

- Steel tube Ø 48.3 mm. hot dip galvanized
- Installation as short scaffold tie with one standard coupler
- Installation as long scaffold tie with two standard couplers

Length (m)	Weight (kg)	Article no.	Price (€)
0,30	1,40	000240	13,00
0,40	1,80	000242	14,40
0,50	2,00	000125	15,10
0,60	2,60	000241	16,40
0,80	3,20	000129	18,40
1,00	3,80	000127	20,40
1,30	4,80	000131	21,40
1,50	5,50	000132	24,70



WALL TIE WITH PLATE  

- Steel tube Ø 48.3 mm. hot dip galvanized
- Installation with a standard coupler



Length (m)	Weight (kg)	Article no.	Price (€)
0,70	2,70	000124	23,30



ANCHOR BRIDGE WDVS



- Set with WDVS bridge and two eye bolts
- For the anchoring of scaffolding to house walls. especially for WDVS when construction in standard version
- Even with a lever arm of 28 cm a sufficient load-bearing capacity is guaranteed in the construction in a standard version parallel to the house wall
- WDVS = Thermal insulation composite system



Weight (kg)	Article no.	Price (€)
3,61	009141	84,60

WALL TIE



- Steel tube Ø 48.3 mm, hot dip galvanized
- Hook is welded at the inside
- Enables close to the facade in conjunction with anchor bridge WDVS connection of scaffold couplers



Length (m)	Weight (kg)	Article no.	Price (€)
0,18	0,95	009190	15,30

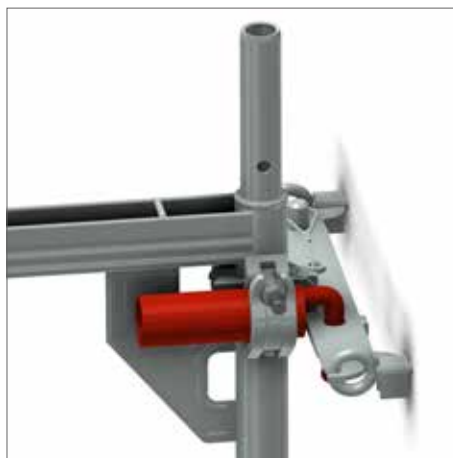

EYE BOLT Ø 12 MM EN

- Galvanized and welded
- For use with plastic expansion plugs 70 / 100 mm and plastic caps natural / black

Length (m)	Thread Length (mm)	Weight (kg)	PU (pcs.)	Article no.	Price (€)
90	54	0,155	150	000358	1,50
120	65	0,175	150	000359	1,70
160	58	0,210	100	000360	1,90
190	65	0,235	100	000363	2,10
230	65	0,265	100	000361	2,20
300	65	0,300	50	002374	2,50
350	65	0,364	50	000362	2,70
400	65	0,424	50	006333	6,00
450	65	0,468	50	007555	6,20
500	65	0,530	50	002983	7,50



EYE BOLT M12 EN

- Galvanized and welded
- With metric thread

Length (m)	Thread Length (mm)	Weight (kg)	PU (pcs.)	Article no.	Price (€)
60	35	0,140	150	012379	5,00
80	35	0,150	150	012383	5,10
100	35	0,160	100	012384	5,20
120	35	0,175	100	012385	5,40
160	35	0,210	100	012386	5,60
220	35	0,260	50	012387	5,90



PLASTIC CAP EN

- For closing anchor drill holes

Colour	Weight (kg)	PU (pcs.)	Article no.	Price (€)
natural	0,003	100	000651	0,20
black	0,003	100	010353	0,20



EXPANSION PLUG EN

- For eye bolts with a timber thread Ø 12 mm
- For drilling Ø 14 mm

Length (m)	Weight (kg)	PU (pcs.)	Article no.	Price (€)
0,07	0,007	100	000357	0,40
0,10	0,007	100	011158	0,40



MJ-SCAFFY EN

- Screw-in aid for eye bolts
- With socket A/F 22 (for standard ratchet wrenches)
- With 3/4 inch square socket
- With SDS drill adapter



Weight (kg)	Article no.	Price (€)
0,374	012600	70,60

LATTICE BEAM STEEL



- Steel tube Ø 48.3 mm, hot dip galvanized
- Load depends on span according to the separate load table

Length (m)	Height (m)	Weight (kg)	PU (pcs.)	Article no.	Price (€)
3,20	0,40	30,00	25	000108	198,50
4,20	0,40	39,00	25	000109	245,80
5,20	0,40	50,00	25	000110	297,80
6,20	0,40	58,00	25	000111	335,40
7,60	0,40	72,00	25	000112	496,30

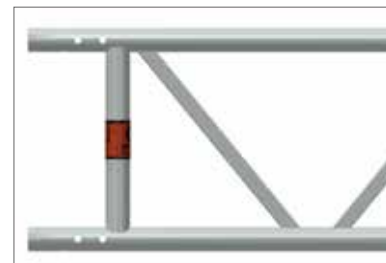

LATTICE BEAM ALUMINUM



- Aluminum tube Ø 48.3 mm
- Load depends on span according to the separate load table

Length (m)	Height (m)	Weight (kg)	PU (pcs.)	Article no.	Price (€)
3,20	0,40	12,00	25	000255	234,00
4,20	0,40	15,00	25	000257	291,00
5,20	0,40	20,00	25	000258	348,00
6,20	0,40	23,00	25	000259	390,10
8,10	0,40	31,00	25	000261	550,00



RIDGE CONNECTOR FRAME



- Steel, hot dip galvanized
- For connecting lattice beams to the roof ridge area
- For gabled roofs with approx. 10° roof pitch

Length (m)	Height (m)	Weight (kg)	Article no.	Price (€)
0,66	0,45	8,00	000113	145,10



TUBE CONNECTOR FOR LATTICE BEAMS



- Steel, hot dip galvanized
- For the continuous extensions of lattice beams

Model	Weight (kg)	Article no.	Price (€)
Straight	1,30	003588	30,50
Short bended	2,00	000283	31,50
Long bended	2,50	000123	34,20



LATTICE BEAM STEEL 1000 

- Steel tube \varnothing 48.3 mm, hot dip galvanized
- Parallel-web lattice beams
- As bridging beam for special constructions with high loads
- Suitable for longer spans

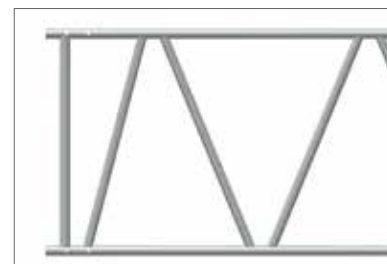

Length (m)	Height (m)	Weight (kg)	PU (pcs.)	Article no.	Price (€)
2,00	1,00	32,00	25	013911	268,10
3,00	1,00	44,00	25	013202	396,30
4,00	1,00	56,00	25	013203	540,80
5,00	1,00	68,00	25	013204	627,00
6,00	1,00	80,00	25	013205	752,90
8,00	1,00	104,00	25	013912	1095,60

BRACING FRAME FOR LATTICE BEAMS 

- Steel, hot-dip galvanized
- With wedge head connections

Length (m)	Height (m)	Weight (kg)	PU (pcs.)	Article no.	Price (€)
2,50	1,00	23,00	25	013246	266,40
2,57	1,00	23,30	25	014021	269,90

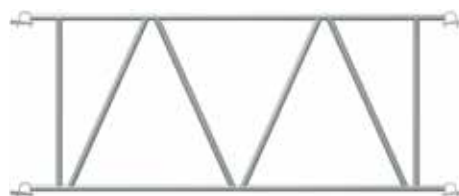
TUBE CONNECTOR FOR LATTICE BEAM 1000 

- Steel tube \varnothing 38 mm, hot dip galvanized
- Straight

Weight (kg)	Article no.	Price (€)
2,00	013253	32,50

BOLT WITH COTTER PIN  

- Screw-free connection of lattice beams
- Replaces usual screws M 12 x 60 mm thereby reducing the assembly time
- Consisting of cotter pin (article no. 002232), bolt (article no. 002235) and washer (article no. 002964)
- All articles are also available separately

Weight (kg)	Article no.	Price (€)
0,09	002237	3,70



SCREW M 12 X 60



- For fixing the tube connector of lattice beams



Weight (kg)	PU (pcs.)	Article no.	Price (€)
0,08	100	010697	3,80

NUT M 12



- For fixing the tube connector of lattice beams



Weight (kg)	PU (pcs.)	Article no.	Price (€)
0,02	200	005817	0,60

DECK LEDGER FOR LATTICE BEAMS UC



- Steel, hot dip galvanized
- With two tube connectors
- For use with bridging with lattice beams

Width (m)	Weight (kg)	Article no.	Price (€)
0,73	5,50	008161	80,60
1,09	9,10	010158	96,10



DECK LEDGER FOR LATTICE BEAMS UNI



- Steel, hot dip galvanized
- For mounting a UNI vertical frame and decks in conjunction with universal lattice beams. e. g. for bridging
- The lattice beams are arranged on the outside of the frame
- The ledger can be slid into position from its secured place by means of the deck

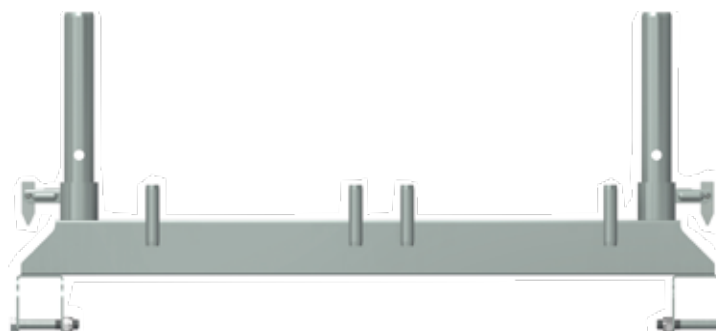

Width (m)	Weight (kg)	Article no.	Price (€)
0,74	6,70	007909	137,80

WALL CONNECTION FOR LATTICE BEAMS



- Steel, hot dip galvanized
- For fastening to the wall, e. g. for bridging constructions
- For lattice beams with 450 mm construction height

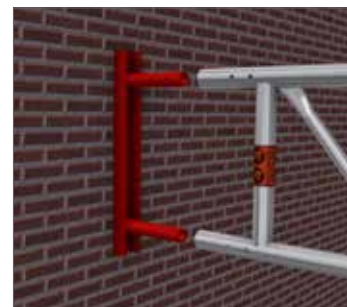

Weight (kg)	Article no.	Price (€)
3,50	000170	78,00

ADAPTER FOR LATTICE BEAM STEEL 1000



- Steel, hot dip galvanized
- With two wedge heads for high durability
- With MJ lattice beams 1.00 m in metric grid



Länge (m)	Höhe (m)	Gewicht (kg)	Art.-Nr.	Preis (€)
0,50	1,00	16,00	014541	235,00

LATTICE BEAM BASE PLATE



- Steel, hot dip galvanized
- Movable
- Use in connection with a decking transom, for further extensions of scaffold pattern when bridging with lattice beams



Weight (kg)	Article no.	Price (€)
6,00	000235	93,60

LEDGER ADAPTER



- Steel, hot dip galvanized
- With modular ledger connection on both sides
- Ledger connection in the system dimension of the vertical standards
- With two wedge locks
- For attaching to all pipes with an external diameter of 48,3 mm at any point



Weight (kg)	Article no.	Price (€)
2,10	013494	27,20

TUBE CONNECTOR WITH HALF COUPLER



- Steel, hot dip galvanized
- Screw fitting for lattice beams, tube or ledger



Length (m)	Weight (kg)	A/F	Article no.	Price (€)
0,30	1,80	22	000223	27,60
0,30	1,80	19	000222	27,60

TUBE CONNECTOR



- Steel, hot dip galvanized
- With U-bracket
- For wedge head connection
- For use for lattice beams, tubes or ledger (Not for U-Ledger)



Length (m)	Weight (kg)	Article no.	Price (€)
0,20	1,90	009726	27,60

TUBE CONNECTOR WITH U-BRACKET



- Steel, hot dip galvanized
- For further construction e.g. for bridging while maintaining of the scaffold grid
- Incl. safety screw
- Also suitable for o- and u-double ledger



Length (m)	Weight (kg)	A/F	Article no.	Price (€)
0,30	2,00	19	008290	33,70

STEEL PLANK 0.30 M



- Steel, hot dip galvanized
- Non-slip surface through pronounced hole profiling
- Height 20 mm (016318)



Length (m)	Width (m)	Weight (kg)	PU (pcs.)	Article no.	Price (€)	
1,00	0,20	4,50	80	014295	52,50	🕒
1,50	0,20	6,75	80	014296	62,00	🕒
2,00	0,20	9,00	80	014297	71,10	🕒
2,50	0,20	11,25	80	014298	80,80	🕒
1,00	0,30	6,75	80	013310	52,10	🕒
1,00	0,30	5,00	80	016385	52,10	🕒
1,50	0,30	9,75	80	013311	61,60	🕒
2,00	0,30	12,80	80	013312	70,70	🕒
2,50	0,30	15,85	80	013313	80,30	🕒

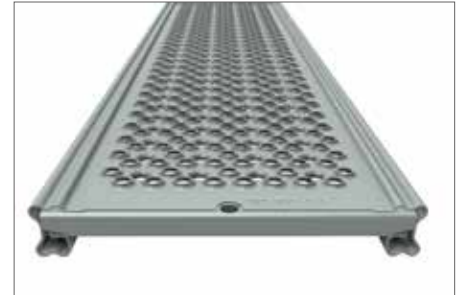

MJ-SPECIAL SCREW



- For use in the holes in the tread and the two extra holes in the head fittings of every SF steel plank 0,30 m (Art. no. 013310 to 013313) from MJ-Gerüst
- For precise guidance through two superimposed holes in the respective treads
- No tilting thanks to double thread with open search tip
- The extra-large flange of the hexagonal head enables even pressure distribution and ensures a more stable and durable fastening

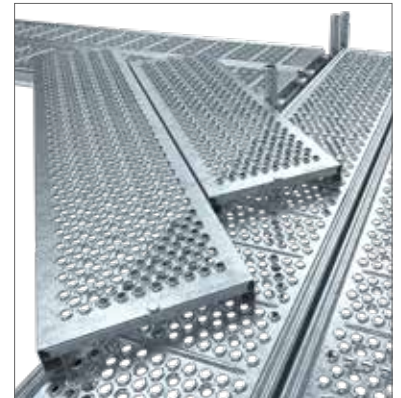

Length (m)	Weight (kg)	A/F	PU (pcs.)	Article no.	Price (€)
0,082	0,092	19	100	014772	2,40

ALUMINUM-BRIDGE



- Slip-resistant aluminium trapezoidal sheet with elegant stucco finish – safe footing in all conditions
- Integrated screw channels for quick installation of guardrail posts and 3-part side protection
- High load capacity – certified load class 2–3 (depending on length)



Length (m)	Width (m)	Weight (kg)	Article no.	Price (€)
4,00	0,60	40,00	016375	633,10
5,00	0,60	50,00	016375	861,40
6,00	0,60	60,00	016377	993,70
8,00	0,60	79,00	016378	1413,80
10,00	0,60	98,00	016562	1820,50

POST FOR ALUMINUM-BRIDGE



- Strong, safe, easy to mount
- Made of robust aluminium tube
- With 2 swivel pins and 1 toe board holder
- Supplied with 2 M8 channel bolts (Halfen type) and 2 self-locking nuts

Length (m)	Weight (kg)	Article no.	Price (€)
1,00	1,85	016379	99,00



ALUMINUM-BRIDGE



- Made of closed rectangular profiles
- Ideal for ceiling scaffolds and bridging thanks to its large span
- According to DIN 4420 for all maintenance work in load class 2 (1.5 kN/m²)
- Depending on the length of the stage, a support of 30 - 50 cm is required
- Adjacent bridge are connected laterally by means of iron rods
- Approved for use in guards and roof guard scaffolds according to DIN 4420

Length (m)	Width (m)	Weight (kg)	Article no.	Price (€)
4,00	0,59	23,00	000646	633,10
5,20	0,59	30,00	000645	861,40
6,00	0,59	35,00	000644	993,70
8,00	0,59	59,00	000643	1413,80

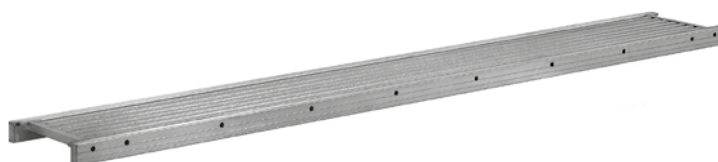

GUARD RAIL HOLDER FOR ALUMINUM BRIDGE UNI/UT



- For mounting the guard rail posts
- This enables easy assembly of the three-piece side guard
- With toe board holder

Weight (kg)	Article no.	Price (€)
2,00	002256	86,10
2,00	003038	86,10



System UNI/UNI TOP (002256)



System UNI-CONNECT (003038)

NON-TILT PROTECTION FOR ALU-BRIDGE



- Steel, hot dip galvanized, drop-forged
- Half coupler with collar nut and welded steel angle to ensure no tilting of the aluminum bridge
- Also usable as deck fastener for the 0.32 m brackets without tube connector

Width (m)	Weight (kg)	A/F	Article no.	Price (€)
0,25	1,30	22	000648	27,70



The system free safety enclosure OPTI-BOARD is the answer to many questions that you may ask yourself when planning your construction site with regard to environmental and noise protection. When renovating or building a new building, the construction site enclosure protects employees and passers by from noise, dust and dirt.

- Light cassette: The transparent version of the OPTI-BOARD enables work in daylight conditions.
- Dust-tight: A circumferential rubber seal makes the OPTI-BOARD almost dust-tight. This enables a clean construction site cladding, the use of vacuum systems (asbestos removal) and weather-independent sandblasting.
- Quick and easy assembly
- Can be use in the UNI, UNI-CONNECT, UNI TOP, COMBI and OPTIMA systems
- Can be installed vertically and horizontally

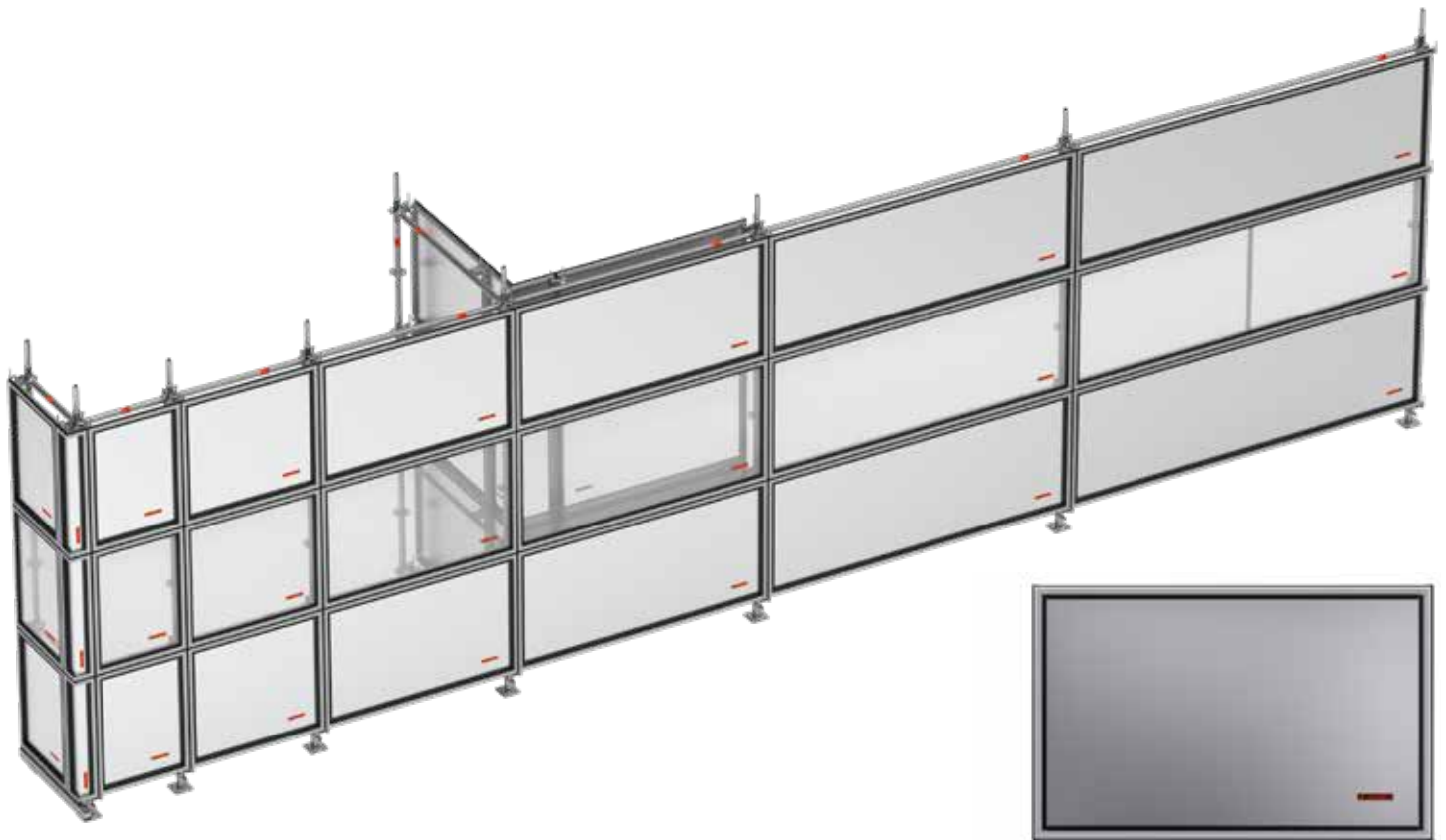

WALLCASSETTE SHEET

Width (m)	Height (m)	Weight (kg)	PU (St.)	Article-no.	Price (€)
0,50	1,00	5,50	14	012064	172,50
0,73	1,00	6,85	14	012076	164,20
1,00	1,00	8,70	14	012065	198,50
1,09	1,00	9,20	14	012077	188,80
1,40	1,00	11,30	14	014421	210,00
1,57	1,00	12,30	14	012078	218,80
2,07	1,00	15,50	14	012079	258,80
2,57	1,00	18,70	14	012080	278,80
3,07	1,00	22,50	14	012081	337,10

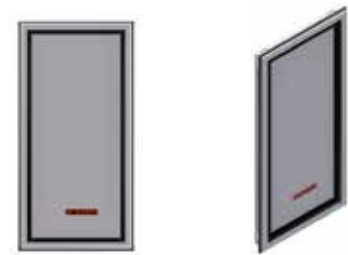

WALLCASSETTE SHEET METRIC



Width (m)	Height (m)	Weight (kg)	PU (St.)	Article-no.	Price (€)
0,50	1,00	5,50	14	012064	172,50
0,65	1,00	6,10	14	012880	170,50
1,00	1,00	8,70	14	012065	198,50
1,10	1,00	9,00	14	012890	191,30
1,50	1,00	12,00	14	012066	229,70
2,00	1,00	15,25	14	012067	273,20
2,50	1,00	18,50	14	012068	301,20
3,00	1,00	22,50	14	012069	351,90



WALLCASSETTE LIGHT



Width (m)	Height (m)	Weight (kg)	PU (St.)	Article-no.	Price (€)
0,50	1,00	4,30	14	012070	189,70
0,73	1,00	5,30	14	012082	180,70
1,00	1,00	6,45	14	012071	224,80
1,09	1,00	6,80	14	012083	213,90
1,57	1,00	8,90	14	012084	295,60
2,07	1,00	11,00	14	012085	345,70
2,57	1,00	13,20	14	012086	406,10
3,07	1,00	15,75	14	012087	446,10

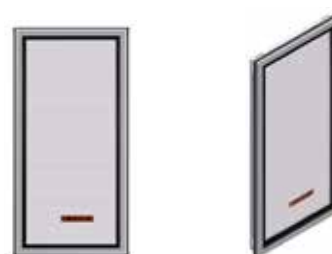

WALLCASSETTE LIGHT METRIC



Width (m)	Height (m)	Weight (kg)	PU (St.)	Article-no.	Price (€)
0,50	1,00	4,30	14	012070	189,70
0,65	1,00	4,70	14	012885	187,70
1,00	1,00	6,45	14	012071	224,80
1,10	1,00	6,60	14	012895	216,70
1,50	1,00	8,60	14	012072	301,50
2,00	1,00	10,70	14	012073	351,60
2,50	1,00	12,80	14	012074	419,40
3,00	1,00	15,40	14	012075	459,40

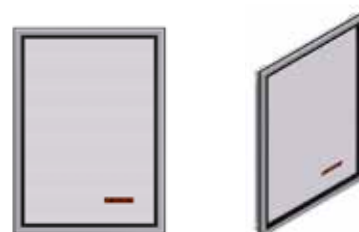

INSIDE CORNER FOR WALLCASSETTE



Width (m)	Height (m)	Weight (kg)
0,40	1,00	6,85
PU (St.)	Article-no.	Price (€)
20	012088	206,10



OUTSIDE CORNER FOR WALLCASSETTE



Width (m)	Height (m)	Weight (kg)
0,17	1,00	3,90
PU (St.)	Article-no.	Price (€)
50	012089	172,80



CASSETTE HOLDER 

System	Weight (kg)	PU (St.)	Article-no.	Price (€)
MODULE	1,00	250	012060	29,40
LEDGER	1,30	250	012061	33,40
TUBE	0,85	300	012062	33,40



CORNER CASSETTE HOLDER 

System	Weight (kg)	PU (St.)	Article-no.	Price (€)
TUBE	1,85	500	012063	58,60



PALETTE 

- Space for 14. pcs. wall cassettes

Length (m)	Width (m)	Weight (kg)	PU (St.)	Article-no.	Price (€)
1,50	1,05	56,5	-	012209	399,00



ESCAPE ROUTE DOOR 

- Block door made of 1.0 mm sheet steel
- With all-round steel profile frame
- Clear width 1.25 m x clear height 2.00 m
- With panic look if required

Weight (kg)	Article-no.	Price (€)
63,00	013453	1.161,50



MJ FASTENING UNIT FOR ESCAPE ROUTE DOOR 

- Sheet steel brackets for mounting MJ escape route doors without tools
- For the installation of an MJ steel escape route door
- 6 fastening units are required

Weight (kg)	Article-no.	Price (€)
0,64	013448	29,90



PROTECTION WALL PROFILE ALUMINUM



- Aluminum profile
- For setting up a robust wall system for partitions between the construction site and the surrounding area
- Any plank, commercially available ISO panels or other panels up to 5.5 cm thick can be used



Length (m)	Weight (kg)	Article no.	Price (€)
2,00	12,9	011647	168,60

HOLDER FOR PROTECTION WALL PROFILE



- Steel, hot dip galvanized
- With half coupling
- Movable couplers connection points for every scaffold situation



Weight (kg)	A/F	Article no.	Price (€)
1,90	22	011662	32,30

GRIDDOOR



- Complete protection against unauthorised access to stairways
- Visible separation between construction site and surroundings
- Assembly and fixing thanks to sliding coupling connection points
- Mesh door for all scaffolding widths thanks to flexible coupling connections

Height (m)	Width (m)	Weight (kg)	Article no.	Price (€)
1,70	0,85	13,00	014603	179,00

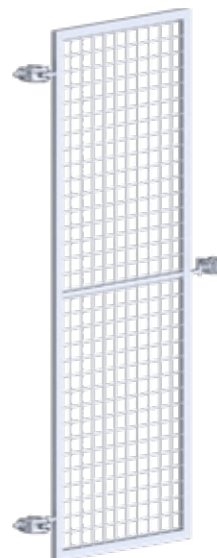

SPECIAL SCAFFOLDING TAPE  

- Self-adhesive special tape
- BAST certified
- For metallic and polyotine substrates
- Retroreflective sheeting according to RSA for inner-city use traffic space in the area of sidewalks and bike paths
- Red / white blocks
- On rolls of 50 m each
- Width optimized for protection wall profile aluminum



Width (mm)	Weight (kg)	Article no.	Price (€)
100	2,40	012570	116,00

WARNING AND PROTECTION BEACON 

- For securing scaffolding on walkways and cycle paths
- Aluminum profile for vertical and horizontal use, with two rotatable couplers on the rear side
- With retroreflective, BAST-certified foil according to RSA for inner-city traffic areas in the area of walways and cycle paths

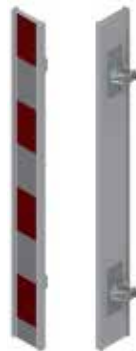

Length (m)	Width (mm)	Weight (kg)	Article no.	Price (€)
1,50	0,15	4,90	013903	109,50

REINFORCING FRAME 

- Steel, hot dip galvanized
- For the connection of two parallel mounted lattice beams
- The riveted half couplers enable quick, safe mounting

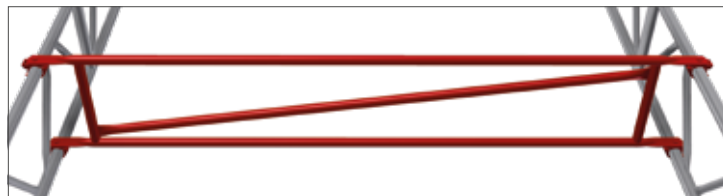

Model	Length (m)	Width (m)	Weight (kg)	PU (pcs.)	Article no.	Price (€)
UNI / UNI TOP	2,50	0,45	17,30	20	000299	160,80
UNI-CONNECT	2,57	0,45	17,60	20	000301	168,00

REINFORCING FRAME WITH CRANKED TOP CORD 

- Steel, hot dip galvanized
- For the connection of two parallel mounted lattice beams
- The riveted half couplers enable quick, safe mounting
- The optimised upper flange design enables improved rain water drainage and avoids the formation of water troughs

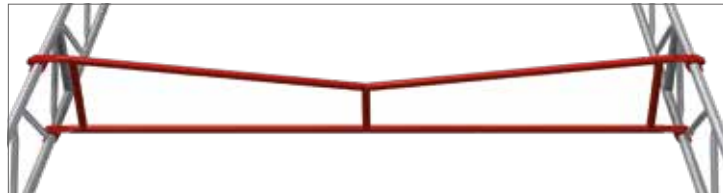

Model	Length (m)	Width (m)	Weight (kg)	PU (pcs.)	Article no.	Price (€)
UNI / UNI TOP	2,50	0,45	13,50	20	004738	170,00
UNI / UNI TOP	3,00	0,45	17,00	20	004378	203,80
UNI-CONNECT	2,57	0,45	13,90	20	004737	170,00
UNI-CONNECT	3,07	0,45	17,60	20	003596	203,80

PVC PIPING TARPS MESH REINFORCED FABRIC

- With lined hemmed on both sides
- Ensures dust and windproof tarpaulin walls
- On the front side welded spring seam possible on request
- Site-specific assembly possible at any time
- Keder tarpaulins with higher strength and desired dimensions available on request

Technical data

Product:	PVC tarp
Material:	PES as per DIN 60001
Fabric coating:	PVC
Grammes per square:	approx. 650g/m ² as per DIN EN ISO 2286-2
Tear strength K/S:	3000 N/5 cm as per DIN EN ISO 1421
Further tearing resistance K/S:	300 N as per DIN EN 1875-3 + DIN 53363
Cold resistance:	-30°C as per DIN EN 1876-1
Heat resistance:	+70°C as per IVK/point 5
Dimensioned tolerance:	+/- 1%



Length (m)	Width (m)	Price (€)
10,00	2,00	18.00 /m ²
10,00	2,07	on request
10,00	2,50	on request
10,00	2,57	on request
10,00	3,00	on request
10,00	3,07	on request

PIPING RAIL ALUMINUM 

- For variable use
- Our keder rails are also available in custom lengths on request

Length (m)	Weight (kg)	Article no.	Price (€)
1,00	1,50	000285	29,50
2,00	3,00	000287	57,60
3,00	4,50	000288	86,10
4,00	6,00	000289	114,60
5,00	7,50	000290	143,20
6,00	9,00	000291	165,60

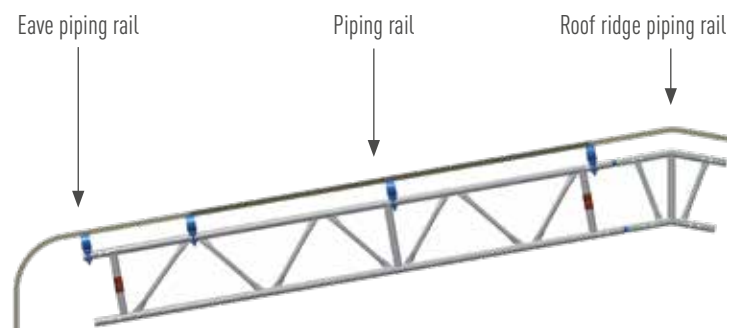
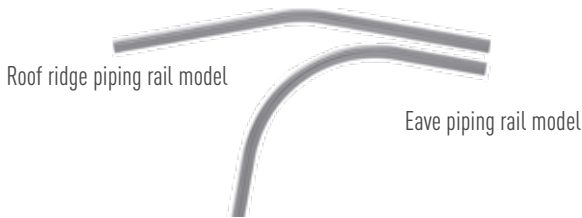
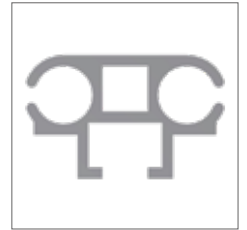

RUBBER SEAL

- For keder rails in the roof area
- The seal is used between the keder rail ends to prevent the dripping of water

Weight (kg)	PU (pcs.)	Article no.	Price (€)
0,005	100	000295	1,85



KEDER RAIL COUPLER ALUMINUM 

- Freely accessible screwing enables subsequent fastening/releasing of the keder rail

Length (m)	Weight (kg)	Article no.	Price (€)
0,20	1,38	007325	34,60



FLAT ROOF GUARD RAIL



- Steel tube, hot dip galvanized
- The MJ flat roof guard rails in conjunction with horizontal ledgers of the MJ COMBI modular scaffold offer a simple and cost-effective solution for securing workplaces on roofs with a working height of more than 3.00 m
- All bay lengths can be variably realised up to 3.07 m with COMBI ledgers
- The upward swiveling of a ballast tube allows a free working area of up to 6 m in width



Seitenschutzsysteme zur
kollektiven
Absturzicherung nach
DIN EN 13374:2019
Klasse A

- ▶ Maßhaltigkeit
- ▶ Form- und
Positionbeständigkeit
- ▶ Festigkeit

www.dekra-stiegl.de



Length (m)	Weight (kg)	PU (pcs.)	Article no.	Price (€)
2,00 / 2,35	14,50	5	008380	123,60

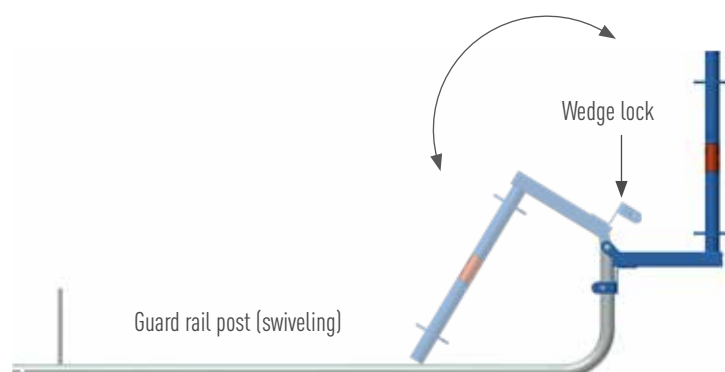

ASSEMBLY AID FOR FLAT ROOF GUARD RAIL



- Steel tube, hot dip galvanized
- Prevents the sideways tilting of the flat roof rail at the start of construction
- Allows the installation for one person



Width (m)	Weight (kg)	PU (pcs.)	Article no.	Price (€)
0,70	6,00	50	010377	41,30

HORIZONTAL BRACING FOR FLAT ROOF GUARD RAIL 

- Steel tube, hot dip galvanized
- Used for horizontal stiffening when lifting the post holder



Width (m)	Weight (kg)	PU (pcs.)	Article no.	Price (€)
0,70	1,90	50	008768	51,90

BALLAST FOR FLAT ROOF GUARD RAIL 

- Mixed plastic, grey/black
- Can also be used as a fence base



Length (m)	Width (m)	Weight (kg)	PU (pcs.)	Article no.	Price (€)
0,78	0,26	22,00	30	003116	27,40

ADJUSTABLE LOCKING DEVICE FOR FLATROOF GUARD RAIL 

- Steel tube, hot dip galvanized



Height (m)	Weight (kg)	Article no.	Price (€)
0,50	2,70	008776	25,70

TOE BOARD HOLDER FOR FLAT ROOF GUARD RAIL 

- Steel tube, hot dip galvanized



Weight (kg)	Article no.	Price (€)
0,60	008779	20,30

NETTING FOR ROOF GUARD SCAFFOLDS AND SIDE GUARDS

EN N

- As per DIN EN 1263-1 and DIN 4420
- The quick and easy way to a safe protective barrier

Color	Length (m)	Width (m)	Weight (kg)	Article no.	Price (€)
green	10,00	2,00	5,00	000195	59,30
green	10,00	1,50	4,00	000191	44,50
green	5,00	2,00	2,50	000185	29,70
green	5,00	1,50	2,00	000199	22,30
red	10,00	2,00	5,00	009551	59,30
red	10,00	1,50	4,00	009702	44,50
red	5,00	2,00	2,50	009703	29,70
red	5,00	1,50	2,00	009704	22,30
blue	10,00	2,00	5,00	011464	59,30
blue	10,00	1,50	4,00	009705	44,50
blue	5,00	2,00	2,50	009706	29,70
blue	5,00	1,50	2,00	009707	22,30



NETTING FOR ROOF GUARD SCAFFOLDS AND SIDE GUARDS ISILINK

EN N

- As per EN 1263-1 and DIN 4420
- With integrated Isilink clips

Color	Length (m)	Width (m)	Weight (kg)	Article no.	Price (€)
green	10,00	2,00	5,00	000198	82,60
green	10,00	1,50	4,00	000192	62,60
green	5,00	2,00	2,50	000189	41,80
green	5,00	1,50	2,00	000201	31,30
red	10,00	2,00	5,00	007955	82,60
red	10,00	1,50	4,00	009708	62,60
red	5,00	2,00	2,50	009709	41,80
red	5,00	1,50	2,00	009710	31,30
blue	10,00	2,00	5,00	009061	82,60
blue	10,00	1,50	4,00	009711	62,60
blue	5,00	2,00	2,50	009712	41,80
blue	5,00	1,50	2,00	009713	31,30



SIDE PROTECTION NET WITH QUICK RELEASE BELT FASTENER

EN N

- The side protection net is attached to the tubes every 750 mm
- A toe board and handrail is required in any case

Color	Length (m)	Width (m)	Weight (kg)	Article no.	Price (€)
green	10,00	2,00	2,50	000197	83,50
blue	10,00	2,00	2,50	006548	83,50

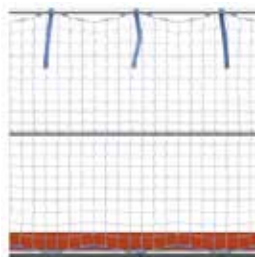

QUICK-ACTION ISILINK CLIP FOR NETTING (DBGM)

N

- Attach at intervals of 50 cm
- The Technical Committee for Construction of the Federation of Professional Trade Associations has awarded GS-Prüfzeichen 97175 for this new Isilink clip connection within the testing and certification body in BG-PRÜFZERT



Color	Weight (kg)	Article no.	Price (€)
black	0,03	000194	0,80

QUICK-ACTION STRAP FOR ASSEMBLING GUARD RAIL NETS

N

- With clamp lock made of metal
- This type of fastening saves an enormous amount of time during assembly
- Attach at intervals of 75 cm



Color	Length (m)	Weight (kg)	Article no.	Price (€)
green	0,60	0,71	000193	1,50
red	0,60	0,71	009700	1,50
blue	0,60	0,71	009701	1,50

SCAFFOLD NETTING

N

- This highly tear-resistant and translucent material
- Rot-proof and UV-stabilized
- Due to its fine net structure (1.8 mm), it offers protection from both dust and rain without heat build-up
- With reinforced edges and polythene eyelets at intervals of 50 cm
- Its low weight (50 g/m²) and high air permeability allows easy assembly in all weather situations



Color	Length (m)	Width (m)	Weight (kg)	Article no.	Price (€)
green	20,00	2,57	3,60	000369	26,70
green	10,00	2,57	1,80	000370	14,60
green	20,00	3,07	4,32	000371	31,40
green	10,00	3,07	2,16	000372	17,00
white	20,00	2,57	3,60	009493	26,70
white	10,00	2,57	1,80	009494	14,60
white	20,00	3,07	4,32	009495	31,40
white	10,00	3,07	2,16	009496	17,00
blue	20,00	2,57	3,60	009714	26,70
blue	10,00	2,57	1,80	009715	14,60
blue	20,00	3,07	3,30	009717	31,50
blue	10,00	3,07	1,75	009718	17,00

SCAFFOLD PROTECTION TARP PREMIUM

N

- These professional customised scaffold protection tarps fit all scaffold systems and framework sizes
- 200 g/m²
- Note changed anchorage points
- Tear resistance approx. 65 kg = 650 N/5 cm

Length (m)	Width (m)	Weight (kg)	PU (pcs.)	Article no.	Price (€)
20,00	2,70	8,60	2	000373	77,70
20,00	3,20	5,70	4	000375	92,10
10,00	2,70	10,60	4	000374	36,30
10,00	3,20	4,20	2	000376	43,00



SCAFFOLD PROTECTION TARP STANDARD

N

- Transparent strip fabric
- 140 - 150 g/m²
- With all-round eyelets
- Tear resistance: approx. 50 kg = 500 N/5 cm

Length (m)	Width (m)	Weight (kg)	PU (pcs.)	Article no.	Price (€)
20,00	2,60	9,36	4	000406	52,00
20,00	3,10	11,20	3	000408	62,00
10,00	2,60	4,68	8	000405	26,00
10,00	3,10	5,58	6	000407	31,00



MESH WEBBING

N

- With welded eyelets

Length (m)	Width (m)	Weight (kg)	Article no.	Price (€)
10,00	2,70	4,00	009745	24,30
20,00	2,70	8,00	009746	48,60
10,00	3,20	4,67	009747	28,50
20,00	3,20	9,25	009748	57,00

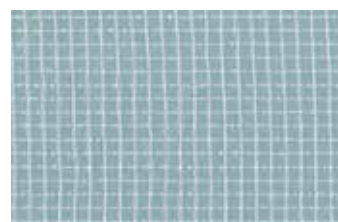

RAY PROTECTION NET

N

- Ribbon weave, PP monofilament
- UV-stabilized
- 140 g/m²

Color	Length (m)	Width (m)	Weight (kg)	Article no.	Price (€)
white	2,70	50,00	18,00	010328	221,50

TARP TIE FLEXI

N

- Ideal for quick and easy attachment of tarpaulins
- Thanks to the flexibility of the material, the tarpaulin is also at high wind forces particularly spared



PU (pcs.)	Article no.	Price (€)
100	006066	1,10

TARP TIE

N

- Used for easy connection between individual tarpaulins or nets using the respective eyelets



PU (pcs.)	Article no.	Price (€)
100	000415	1,50

QUICK TIE

N



Length (m)	Weight (kg)	PU (pcs.)	Article no.	Price (€)
0,30	0,008	100	000377	0,13

ONE-WAY PLASTIC TIE

N

- High tear resistance



Length (m)	PU (pcs.)	Article no.	Price (€)
0,282	100	000378	0,06

SCAFFOLD CORD

N

- Polypropylene 8 mm

Color	Length (m)	Article no.	Price (€)
white-blue	2,00	002308	1,80

ACCESS LADDER ALUMINUM



- Aluminum
- As a separate ladder for the inside scaffold climbing
- With welded claws for safe mounting to the access decks



Length (m)	Width (m)	Weight (kg)	Article no.	Price (€)
2,16	0,40	3,00	001323	80,70

ACCESS LADDER STEEL



- Steel, hot dip galvanized
- As a separate ladder for the inside scaffold climbing
- With welded claws for safe mounting to the access decks



Length (m)	Width (m)	Weight (kg)	PU (pcs.)	Article no.	Price (€)
2,16	0,40	10,50	80	000172	79,90

SQUARE PLUG

- Black
- For access ladder aluminum



Length (m)	Width (m)	Weight (kg)	PU (pcs.)	Article no.	Price (€)
0,03	0,04	0,01	100	008442	0,60

SQUARE PLUG

- Black
- For access ladder steel



Length (m)	Width (m)	Weight (kg)	PU (pcs.)	Article no.	Price (€)
0,02	0,04	0,01	100	008441	0,60

VERTICAL LADDER STEEL



- The side rails are of $\varnothing 48.3 \times 3.2$ mm, hot dip galvanized
- Standard coupler connection is ensured
- This robust ladder has become the first choice in industry for heavy-duty applications
- The ladder can be extended using normal tube connectors

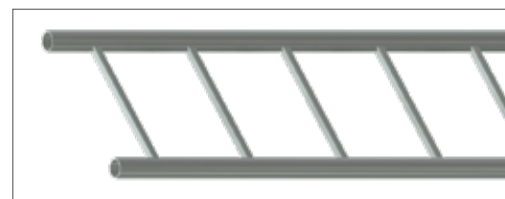

Length (m)	Width (m)	Weight (kg)	Article no.	Price (€)
2,00	0,45	21,00	000227	126,60
3,00	0,45	28,50	000228	174,70
4,00	0,45	34,50	000229	240,00
5,00	0,45	44,50	000230	309,90

VERTICAL LADDER ALUMINUM



- With riveted tube connectors
- Suitable for all types of scaffold, also to use for ladder scaffold
- TÜV inspected
- Is fastened with standard couplers
- Distance between rungs 28 cm, width 47 cm
- Plastic base included

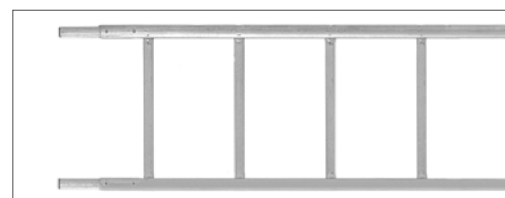

Length (m)	Width (m)	Weight (kg)	Article no.	Price (€)
2,00	0,47	5,80	000409	160,30
3,00	0,47	8,00	000410	174,50
4,00	0,47	10,00	000411	226,00
5,00	0,47	12,60	000412	275,00
6,00	0,47	14,50	000413	325,70

SCAFFOLD PALLET FOR VERTICAL FRAME



- Steel tube, hot dip galvanized
- Continuous fork mount for safe fork-lift transport
- Additional cut-outs allow side retracting
- Capacity: 20 Assembly frames

System	Length (m)	Width (m)	Weight (kg)	PU (pcs.)	Article no.	Price (€)
UC 70/ UNI 70	1,11	0,79	31,10	5	008317	301,90
UC 100/ UNI 100	1,11	1,16	38,70	5	008367	328,10
UT 65	1,12	0,74	28,50	5	008363	248,60
UT 100	1,12	1,09	36,10	5	008406	278,60

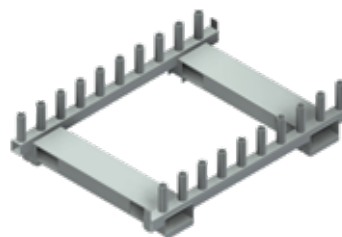

STORAGE AND TRANSPORT FRAME FOR VERTICAL FRAME



- Steel tube, hot dip galvanized
- Double base frame allows lateral retraction
- Filled stackable
- Cranable with additional eyelets
- Capacity varies

System	Model	Length (m)	Width (m)	Weight (kg)	Article no.	Price (€)
UC 70/ UNI 70	42 Frames	2,41	0,78	108,00	010691	1112,80
UC 100/ UNI 100	42 Frames	2,41	1,14	114,00	010597	1164,50
UT 65	34 Frames	2,37	0,71	85,00	011052	1112,80
UT 100	34 Frames	2,37	0,74	85,00	011083	1164,50

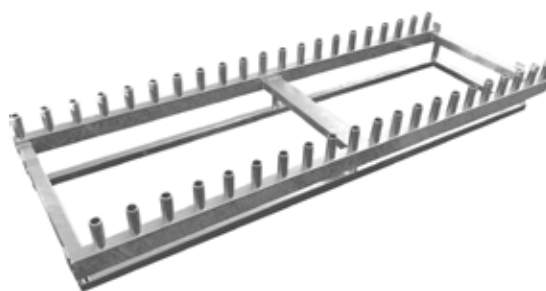

STACK PALLET



- Steel, hot dip galvanized
- Cannot be dismantled
- With four cranes eyes for receiving crane hooks
- Can be combined with grid boxes

Length (m)	Width (m)	Weight (kg)	Article no.	Price (€)
1,20	0,80	42,00	010176	377,40



STACKINGBOX

- With four eyes for transport by a crane
- Load up to 2.000 kg
- Stackable

Length (m)	Width (m)	Weight (kg)	Article no.	Price (€)
1,00	0,80	53,00	010362	288,60



STACKING PALLET FOR TUBES



- Steel tube, hot dip galvanized
- Specially suited for module scaffolds, e. g. standards, ledgers, guard rails, diagonal braces, tubes and toe boards
- Open all round
- Suited for stacked and crane transports
- The tubular supports are removable and are to be stowed securely in the base frame so that empty pallets can be transported and stacked in a very space-saving manner
- Special orders on request
- Push-on tube with bevel on one side, also available separately (Article no. 005791)



Length (m)	Width (m)	Weight (kg)	PU (pcs.)	Article no.	Price (€)
0,85	0,85	30,50	5	006962	232,20
1,25	0,55	31,80	5	010334	231,90
1,25	0,85	35,00	5	005614	240,20
1,50	1,05	56,50	5	012209	399,00

MJ BEARING FOOT A/F 19



- Steel, hot dip galvanized
- With welded half coupler A/F 19
- For easy assembly of dismantlable stacking frames made of scaffold components
- Very low space requirement for storage and transport

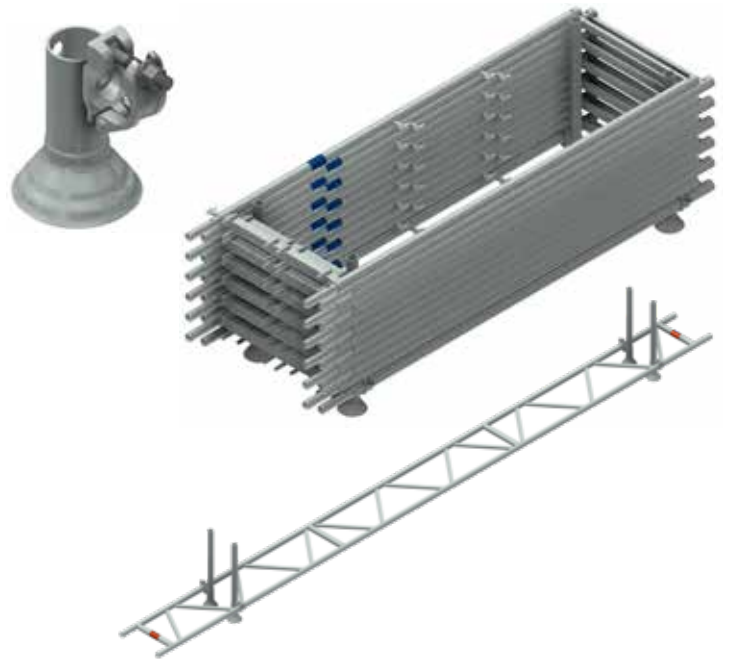

Weight (kg)	A/F	Article no.	Price (€)
1,80	19	013980	44,20
1,80	22	016131	44,20

PALLET FOR TUBES



- Steel, hot dip galvanized
- Cannot be dismantled



Length (m)	Width (m)	Weight (kg)	Article no.	Price (€)
1,10	0,60	39,90	007980	270,40

INDUSTRIAL LATTICE BOX



- Steel, lacquered RAL 7030
- With timber deck
- On a side with half flap



Fill height (m)	Length (m)	Width (m)	Weight (kg)	Article no.	Price (€)
0,80	1,24	0,84	85,00	002249	369,10
0,40	1,24	0,84	75,00	009749	322,40
0,33	1,24	0,84	69,00	009750	332,00

TENSIONING BELT

- With profile hook
- Traction 5000 daN



Length (m)	Weight (kg)	Article no.	Price (€)
8,00	2,52	009618	40,80

PACKAGING TAPE

- Painted with zinc dust
- 0.5 x 16 mm (as a slice)

Length (m)	Weight (kg)	Article no.	Price (€)
796,00	25,00	016834	222,00

STRAPPING TOOL FOR PACKAGING TAPE

- Without sleeve on 13/16/19 x 0.5 mm adjustable



Weight (kg)	Article no.	Price (€)
4,90	002428	1965,00

DISPENSER FOR STEEL STRIP

- With band brake
- With rubber tires



Weight (kg)	Article no.	Price (€)
31,00	002429	571,70

RIFFEL SHEET METAL FLAP FOR HATCH DECKS



- For repair of hatchdecks
- Delivery includes snaplock and hinges



System	Length (m)	Width (m)	Weight (kg)	Article no.	Price (€)
UC	0,75	0,52	4,40	007550	121,00
UNI	0,76	0,53	4,80	008366	129,40
UT	0,76	0,48	4,40	008456	129,40

BOARD FOR PLYWOOD FLAP



- For repairing access decks
- Other dimensions available on request

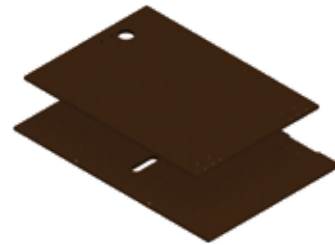

System	Length (m)	Width (m)	Weight (kg)	Article no.	Price (€)
UC	0,70	0,50	1,90	002814	79,90
UNI	0,80	0,54	2,30	001527	84,00

BOARD FOR DECK



- For repairing access decks and combi decks
- Typ BFU 100 G-12 (G-Guard)
- Available in 9.8 mm and 12 mm thickness
- Dimensions and prices on request



DECK PROFILE ALUMINUM



- For repairing access decks and decks
- Special lengths on request



Length (m)	Width (m)	Weight (kg)	Article no.	Price (€)
5,57	0,25	8,40	001300	121,80

REPAIR ACCESSORIES FOR ACCESS DECKS



Snap lock for the access flaps

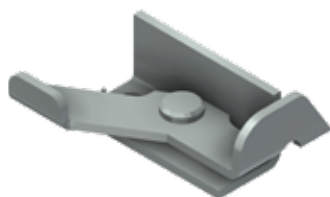

Ladder lock for access hatches



Hinge for access hatches



Article text	Article description	Weight (kg)	Article no.	Price (€)
Snap lock for the access flaps	For the systems UNI-CONNECT, UNI and UNI TOP	0,11	002172	11,60
Ladder lock for access hatches	For the systems UNI-CONNECT, UNI and UNI TOP	0,17	001795	11,60
Hinge for access hatches	For repairing combi access decks	0,30	002043	6,10

REPAIR ACCESSORIES FOR BOARD SHOES



Steel board shoe HB



Steel board shoe UNI



Steel board shoe with claws UC



Steel board shoe UT



Article text	Article description	Width (m)	Weight (kg)	Article no.	Price (€)
Steel board shoe HB	For HB wooden floor	0,32	1,30	007536	20,10
Steel board shoe UNI	For wooden floor UNI	0,32	0,80	001506	13,90
Steel board shoe with claws UC	For wooden floor UNI-CONNECT	0,32	1,10	001415	21,30
Steel board shoe UT	For wooden floor UNI TOP	0,29	0,64	001508	13,90

REPAIR ACCESSORIES FOR TIMBER DECKS AND TOE BOARDS

Z

Rivet 23 x 1 x 54 mm



Rivet 12 x 1 x 54 mm



Rivet 8 x 1 x 42 mm



Article text	Article description	Weight (kg)	Article no.	Price (€)
Rivet 23 x 1 x 54 mm	For wooden floor UNI	0,03	001811	1,10
Rivet 12 x 1 x 54 mm	For wooden floor UNI-CONNECT and UNI	0,01	001805	0,90
Rivet 8 x 1 x 42 mm	For UNI-CONNECT, UNI and UNI TOP toe board fittings	0,01	001820	0,70

REPAIR ACCESSORIES FOR TOE BOARDS

Z

Toe board fitting UC



Toe board fitting UNI



Front toe board fitting UC + UNI



Article text	Article description	Weight (kg)	Article no.	Price (€)
Toe board fitting UC	For toe board UNI-CONNECT	0,40	004203	6,70
Toe board fitting UNI	For toe board UNI	0,40	006511	6,70
Front toe board fitting UC + UNI	For front toe board UNI-CONNECT and UNI, two pieces per toe board	0,15	002039	2,70

REPAIR ACCESSORIES FOR ALUMINUM DECKS



Steel shoe for aluminum deck UC



Steel shoe for aluminum deck UNI



Steel shoe for aluminum deck UT



Article text	Article description	Weight (kg)	Article no.	Price (€)
Steel shoe for aluminum deck UC	For easy repair of the aluminum decks UNI-CONNECT	1,20	006624	23,10
Steel shoe for aluminum deck UNI	For easy repair of the aluminum decks UNI	1,60	007000	23,10
Steel shoe for aluminum deck UT	For easy repair of the aluminum decks UNI TOP	1,40	007976	23,10

REPAIR ACCESSORIES



Ringbolt M 14



Bolt-on swivel pin



Spring plug



Article text	Article description	Weight (kg)	Article no.	Price (€)
Ringbolt M 14	For handrail support and and fixing top decking	0,14	001761	4,60
Bolt-on swivel pin	For the mounting a guard rail	0,10	000169	7,80
Spring plug	For fold up scaffold and rolling scaffold	0,10	001253	2,50

WAVES BAND IRON 18 X 1 MM N

- Prevents tearing and splitting during drying or through mechanical stress on wooden planks



Length (m)	Weight (kg)	Article no.	Price (€)
50,00	7,20	010356	220,00

ALUMINUM LADDER FOR HATCH DECKS Z

- For repair of hatchdecks



Length (m)	Weight (kg)	Article no.	Price (€)
2,13	3,10	002624	70,50

ALUMINUM LADDER EXTENDABLE Z

- For repair of hatchdecks 2.00/2.07 m



Length (m)	Weight (kg)	Article no.	Price (€)
2,13	5,70	001324	160,00

RATCHET

N

- Special model with steel head and aluminum handle



A/F	Weight (kg)	Article no.	Price (€)
22	0,70	002486	108,00
19	0,70	000364	108,00

DOUBLE SIDED RATCHET

N

- With locking wheel



A/F	Weight (kg)	Article no.	Price (€)
22/24	0,90	000368	124,00
19/22	0,90	000367	124,00

Spare parts for ratchet - Article no. 002486 / 000364 / 000368 / 000380	Article no.	Price (€)
Locking wheel A/F 19	001192	on request
Locking wheel A/F 22	001193	on request
Locking wheel A/F 19	001195	on request
Locking piece	001189	on request
Cover	001199	on request
Locking pin	001201	on request
Switch lever	001203	on request
Circlip 54 I	001202	on request
Button-head rivets 5.0 x 25 DIN 660	001208	on request
Button-head rivets 2.5 x 20 DIN 660	001206	on request
Pressure spring	001205	on request
Pin 2 x 12 mm	001207	on request
Case	001190	on request
Aluminum handle	001191	on request

DOUBLE SIDED RATCHET

N

- Lightweight model



Color	A/F	Weight (kg)	Article no.	Price (€)
silver	19/22	0,53	000380	35,00
silver	21/23	0,53	012520	35,00

ROOFING HAMMER WITH MAGNET

N

- Roofer hammer with forged head and nail holder
- Extra long handle for extra leverage
- Magnetized recess at the end of the hammer, spares costly stopping of nails



Weight (kg)	Article no.	Price (€)
0,60	007617	25,00

MJ-RATCHET HOLSTER

N

- Made of high quality leather
- Easy and safe attachment of a ratchet



Weight (kg)	Article no.	Price (€)
0,07	014248	16,90

MAGNET WATER SCALE TORPEDO

N

- Robust die-cast aluminum profile
- With rare earth magnet and hole for carabiner hooks

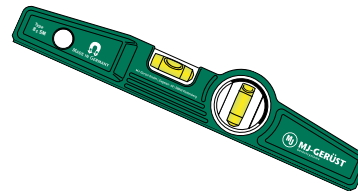

Length (m)	Weight (kg)	Article no.	Price (€)
0,25	0,22	010359	24,60

BELT BAG FOR THE WATER SCALE

N

- Robust, lightweight material
- With loop for easy attachment to the belt



Weight (kg)	Article no.	Price (€)
0,06	010845	6,00

ADVERTISING TARP



- Individual motif
- Various sizes and assemblies are possible



Amount	Length (m)	Width (m)	Weight (kg)	Price (€)
1-5 tarps	2,00	2,50	450 g/m ²	on request
10-20 tarps	2,00	2,50	450 g/m ²	on request

ADVERTISING SIGN 1.00 X 0.65 M WITH FRAME MOUNTED



- Frame made of steel tube Ø 48.3 mm, hot dip galvanized
- With mounted, custom-printed, aluminum dibond plate
- Can be mounted with couplers anywhere on the scaffold
- Couplers not included (see page 10)



Length (m)	Width (m)	Weight (kg)	Article no.	Price (€)
1,13	0,80	12,50	010865	357,20

SET - PERSONAL PROTECTIVE EQUIPMENT MILLER 1

EN N



- Revolution R2 comfort harness - with 80 cm rear eyelet extension (EN 361), made of stretchy DuraFlex webbing, sharp edge tested, front and rear eyelets, comfort padding on the back, automatic fastenings for quick on and off, belt end clips, swivel joint at waist height for optimal ergonomics when bending over or stretching, attachment point for tools and accessories, integrated label compartment, material life is 10 years
- Fixing means with strap fall attenuartor - length 2.00 m, sharp-edge tested, horizontally approved (stopping point at base height), 63 mm scaffold hook, flexible design for added movement, safety clip to fasten safety harness, teflon-coated for longer service life, EN 354 and EN 355
- Equipment bag - 0.27 m x 0.80 m (D x H), made of PVC, red



Size	Article No.	Price (€)
S - M	006273	on request
L - XL	005610	on request

ALL SET COMPONENTS MAY ALSO BE ORDERED SEPARATELY

EN N

Revolution R2 comfort harness

Fixing means with strap fall attenuartor

Y-shock absorber Twin manyard EDGE 2.00 m

Equipment bag



Article text	Article No.	Price (€)
Revolution R2 comfort harness (Size L - XL)	011285	on request
Fixing means with strap fall attenuartor	007671	on request
Y-shock absorber Twin Manyard EDGE 2.00 m	011286	on request
Equipment bag	011287	on request

SET - PERSONAL PROTECTIVE EQUIPMENT MILLER 2

EN N



- Revolution R2 comfort harness - with 80 cm rear eyelet extension (EN 361), made of stretchy DuraFlex webbing, sharp edge tested, front and rear eyelets, comfort padding on the back, automatic fastenings for quick on and off, belt end clips, swivel joint at waist height for optimal ergonomics when bending over or stretching, attachment point for tools and accessories, integrated label compartment, material life is 10 years
- Y-shock absorber Twin manyard EDGE 2.00 m - with 2 x 63 mm aluminum hooks (EN 354 + 355), sharp edge tested, integrated shock absorber with drop indicator, material life is 10 years
- Equipment bag - 0.27 m x 0.80 m (D x H), made of PVC, red



Size	Article No.	Price (€)
L - XL	011284	on request

KASK INDUSTRIAL CLIMBING HELMET SUPERPLASMA A0 EN ID N

- Tested and approved according to EN 397
- With chin strap
- Adjusting wheels allow one quick and easy adjustment to the right size
- With ring for attaching the helmet to a belt



Color	Article no.	Price (€)
dark blue	010496	74,60
white	010497	74,60
yellow	010498	74,60
orange	010499	74,60
red	010500	74,60
green	010501	74,60
dark green	010502	74,60
light blue	010503	74,60
black	010453	74,60

KASK INDUSTRIAL CLIMBING HELMET ZENITH EN ID N

- Tested and approved according to EN 397 and EN 50365
- Various settings allow a quick and easy adjust
- With ring for attaching the helmet to a belt



Color	Article no.	Price (€)
blue	010504	84,70
white	010505	84,70
yellow	010506	84,70
orange	010507	84,70
red	010508	84,70
green	010509	84,70
black	010510	84,70

KASK PLASMA NECK PROTECTOR EN N

- Neck protector for KASK safety helmet Plasma
- The neck protector can be attached to any KASK Plasma helmet
- Protects the neck and neck area from sunlight and splashing



Color	Article no.	Price (€)
grey	010958	24,00

KASK VISOR FULL FACE VISIER

EN N

- Anti-fog and scratch-resistant treatment
- Panoramic lens compatible for overlapping corrective glasses
- Drip proof upper contour made of rubber
- Impact resistant even at extreme temperatures
- Protection of a larger area of the face



Weight (kg)	Article no.	Price (€)
0,12	012013	45,50

UVEX PROTECTIVE HELMET ALPINE

EN ID N

- For height work and rescue
- Tested and marked according to EN 397 (industrial protection helmets) and EN 12492 (mountaineering helmets)

Color	Article no.	Price (€)
white	009684	93,50
red	009685	93,50
yellow	009686	93,50
orange	009687	93,50
green	009688	93,50
blue	009689	93,50
black	009690	93,50



UVEX PROTECTIVE HELMET PHEOS S-KR

EN ID N

- Tested and approved according to EN 397
- With four-point chin straps according to DIN 397 pre assembled on the helmet



Color	Article no.	Price (€)
white	009392	31,50
black	009393	31,50
yellow	009394	31,50
blue	009395	31,50



WWW.MJ-SCAFFOLDING.COM



OPTIMA

Flexible façade scaffolding



OPTIMA METRIC

Flexible façade scaffolding



OPTIMA TOP

Flexible façade scaffolding



UNI-CONNECT

Frame System 73/109

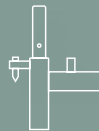

UNI

Frame System 70/100



UNI TOP

Frame System 65/100



COMBI

Modular System



WALL AND ROOF

Enclosure



ACCESSORIES

Universal