

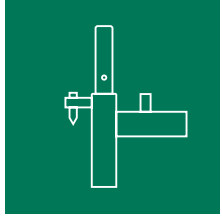

**MJ-GERÜST**  
Scaffolding Systems

[WWW.MJ-SCAFFOLDING.COM](http://WWW.MJ-SCAFFOLDING.COM)     



**UNI**

**PRICES** | EDITION 04.2025



---

**SCAFFOLDING MADE IN  
PLETTENBERG**

## SCAFFOLDINGS MADE IN PLETTENBERG

MJ-Gerüst GmbH, based in Plettenberg in the German region of Sauerland, is part of a strong group of companies, which can look back on more than 50 years of company history. The core competence of the family company lies in the production and worldwide distribution of high-quality steel and aluminum scaffolding systems, which offer almost limitless possibilities in the field of modern system scaffolding construction.

With a unique range of products and a wide range of universal accessories, we offer our customers the option of completing existing scaffolding material in a system-compatible complement. A highly valued advantage by our customers that has given our scaffolding international recognition and prominence.

Development, production and sales. These are the cornerstones of our range of services, which are supplemented by numerous additional services. Especially our support in the planning and implementation of difficult projects is claimed. A service in which our technical know-how and experience can often contribute to considerable time and cost savings.

Only through qualified work can a safe quality product be created. Our proven quality management reflects our knowledge and experience and makes the quality of our products measurable. In order to guarantee our high quality standards, our production processes are constantly accompanied by external examination offices and engineers.



## OUR COMPANY - YOUR BENEFITS

- Production in Germany at the location Plettenberg
- System compatible, high quality and norm compliant scaffold systems
- Certifications according to DIN EN 9001, 14001 and 50001
- Highest product quality through dynamic quality management
- Short-term availability of material due to high storage capacities and short decision-making processes
- Use of the modern production technology and permanent optimization of technological production running
- Project support already in the planning phase

## PARTNER AND CERTIFICATES



BUNDESINNING  
GERÜSTBAU

MPA NRW



SGUV  
SESE  
SISP  
Schweizerischer Gerüstbau-Unternehmer-Verband  
Société des Entrepreneurs Suisse en Echafaudages  
Società degli Imprenditori Svizzera dei Porteggi

Deutsches  
Institut  
für  
Bautechnik





WWW.MJ-SCAFFOLDING.COM



The system	04
Base jacks	06
Starting transom	07
Frames	08
Decks	13
Climb up	15
Reinforcement	17
Guard rails	18
Toe boards	19
Upper close-off and roofguard	20
Anchoring	23
Brackets	26
Climb up, Stairs	31
Gap cover for stairs	33
Stairs	34
Transom	36
Deck fastenings	38
Gap cover	40
End guard rail	42
Brackets	43
Weather protection	44
Rolling tower and castors	45
Head and base attachments	46
Couplers, Dscaffold tubes	47
Lattice beams	49
Storage and transport	52
Securing during assembly of the scaffold	53
Scaffold examples	58
Notes	60
Order form	63

 Made in Plettenberg

 Net price, not discountable

 European standard

 Grant BG BAU

 Individual identification

 Delivery time on request

All prices exclude VAT applicable at the time of shipment. All dimensions and weights are non-binding approximate values. Technical data is subject to change without prior notice. Prices are charged as applicable on the day of shipment. Sale is subject exclusively to our sales terms and delivery conditions. An excerpt: place of business and jurisdiction is Plettenberg. Extended retention of title until full payment of all outstanding claims. Our prices are ex works.

## UNI: SIMPLY - FAST - SAFE

The facade scaffold UNI is generally approved by the German Institute for Construction Technology in Berlin under the approval numbers Z-8.1-184 (UNI 70) and Z-8.1-871 (UNI 100). The high quality of the system is based on the optimal ergonomic design, the durable material properties and the assembly logic that constructions error practically excludes. Its essential identifying features are the round bolt connections and the swivel pins.

The individual scaffold bays are connected by decks which are placed on the round bolts of the vertical frames so that the system can be erected in virtually no time. This also rules out the risk of the decks slipping. The swivel pins in the vertical frames are used to fasten guard rails and diagonal braces without the use of tools.

In its standard design, the UNI 70 scaffold system can be used as a scaffold system of scaffold group 3 according to DIN 4420-1:1990 and as guard and roof guard scaffold. The UNI 100 scaffold system can be used, depending on bay width, for load classes 4 to 6 for scaffolding according to DIN EN 12811-1:2004. The use of a roof guard is accounted for in the standard design.

With extensive and functionally aligned accessories, the system is able to achieve a degree of flexibility that also enables scaffolding for challenging objects.



### EFFICIENT

due to optimized ease of assembly



### PROFITABLE

through long life and excellent value retention



### FLEXIBLE

through countless field lengths/widths



### LOADABLE

up to 6 kN/m<sup>2</sup> full surface  
up to 10 kN/m<sup>2</sup> as partial surface load



## THE ESSENTIAL BENEFITS OF THE SYSTEM IN OVERVIEW

- Horizontal bracing with round bolt deck arresting
- Short assembly times without the use of any additional tools due to modular structure
- High safety features: decks are firmly locked to the vertical frames, inherent and vertical moving loads are discharged directly by the decks lying on the vertical frames
- Independent perpendicular adjustment through fixed knot connections: after initial alignment of the lowest levels, the alignment of all further scaffold levels takes place automatically
- Complete usability of the working width due to outside diagonal braces
- Decks made of timber, steel and aluminum
- Gen. approved by building inspection, also for common, manufacturer independent use.

For details on type and scope, please refer to the approval models: Z-8.1-184, Z-8.1-871, Z-8.1-303



Set up adjustable base jacks, place lower diagonal fasteners, mounting guard rails (only in the diagonal field).

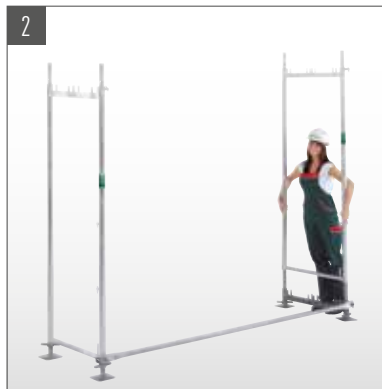

Mount vertical frames.



Mount diagonal brace on swivel pins.



Mount decks, align perpendicularly to guard rail and frame with water level.



Mount inside access deck.



Assemble vertical frames and decks of the next level, then mount diagonal braces, guard rails and toe boards.

Visit us on:



[WWW.GERUESTLAGER.DE](http://WWW.GERUESTLAGER.DE)

**UNDERLAY WOODS**

- As a load-distributing support
- Sawn
- Dimension +/- 10 mm



Length (m)	Width (m)	Height (m)	Weight (kg)	PU (pcs.)	Article no.	Price (€)
1,00	0,24	0,04	1,50	80	009203	10,20
1,50	0,24	0,04	2,25	80	010360	12,30

**PROTECTIVE PAD FOR BASE JACK**

- Plastic
- With reflector

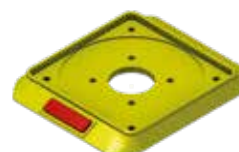

PU (pcs.)	Article no.	Price (€)
80	008110	4,40

**RUBBER PAD FOR BASE JACK**

- Made from recycled cable material
- Oil and acid resistant
- Stackable (015339)



Height (m)	Width (m)	Weight (kg)	PU (pcs.)	Article no.	Price (€)
0,03	0,24	1,60	80	015338	15,10
0,03	0,24	1,50	80	015339	15,10

**BASE JACK**

EN

- Steel, hot dip galvanized
- With tube spindle
- Base plate 150 x 150 mm
- For adjusting level with differences in height of the underground
- Knurled nut with collar for centring the shaft on the spindle
- Lock to prevent unscrewing of the knurled nut and to ensure the necessary bridging length
- Can be used as a head spindle (P. 44)



Length (m)	Weight (kg)	PU (pcs.)	Article no.	Price (€)
0,30	2,40	375	000318	17,80
0,50	3,10	300	000319	21,30
0,60	3,40	300	000320	22,00
0,78	3,90	250	000321	29,80
1,00	4,70	200	000322	35,70

## SWIVEL BASE JACK

EN

- Steel, hot dip galvanized
- With tube spindle
- Swiveling base plate 150 x 150 mm
- For adjusting level with differences in height of the underground
- Knurled nut with collar for centring the shaft on the spindle
- Lock to prevent unscrewing of the knurled nut and to ensure the necessary bridging length
- Can be used as a head spindle
- Additional longitudinal scaffold bracing required at in the base
- Permissible load: 25.4 kN



Länge (m)	Gewicht (kg)	VPE (Stk.)	Art.-Nr.	Preis (€)
0,50	3,10	250	000323	46,30
0,80	4,30	200	013292	54,50

## STARTING TRANSOM



- Steel, hot dip galvanized
- As lower beginning when stair ascent and inside ascent
- May also be used in conjunction with adjustment tubes

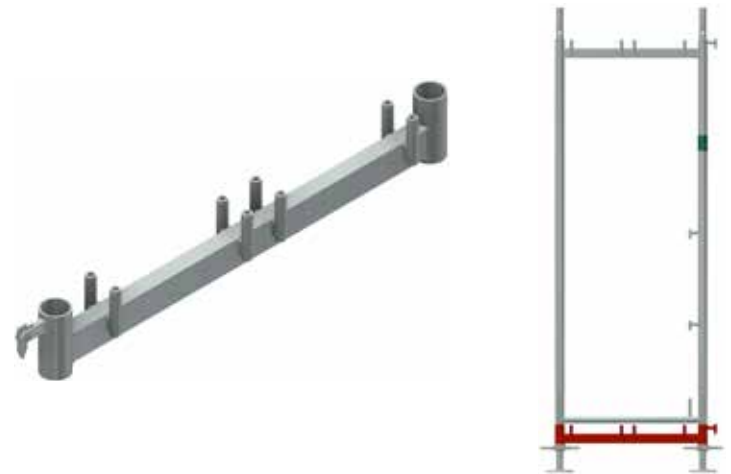

Width (m)	Weight (kg)	Article no.	Price (€)
0,74	4,00	000219	51,90
1,10	4,50	000220	61,40

**YOU WILL FIND MORE PARTS ON PAGE 45  
AND OUR PRICE LIST "ACCESSORIES".**

## ASSEMBLY FRAME STEEL 70



- Steel tube Ø 48.3 mm, hot dip galvanized
- With round bolts for safe mounting of the scaffold floors
- Steel tubes perforated for securing options by security pin
- Self-locking swivel pins for mounting back guard rails and diagonal braces

Height (m)	Width (m)	Weight (kg)	PU (pcs.)	Article no.	Price (€)
0,50	0,74	8,50	50	000026	84,70
1,00	0,74	10,90	50	000025	91,20
1,50	0,74	14,00	25	000267	99,10
2,00	0,74	16,50	25	000004	100,40



## ASSEMBLY FRAME STEEL 100



- Steel tube Ø 48.3 mm, hot dip galvanized
- With round bolts for safe mounting of the scaffold floors
- Steel tubes perforated for securing options by security pin
- Self-locking swivel pins for mounting back guard rails and diagonal braces
- The assembly frame UNI 100 meets the requirements of width class A/F 09 and is designed for highly loaded scaffolds up to load class 6

Height (m)	Width (m)	Weight (kg)	PU (pcs.)	Article no.	Price (€)
0,50	1,10	12,20	50	000029	100,40
1,00	1,10	15,00	50	000028	109,60
1,50	1,10	19,20	25	000269	118,70
2,00	1,10	21,90	25	000027	132,40



## ASSEMBLY FRAME STEEL 70/100



- Steel tube Ø 48.3 mm, hot dip galvanized
- With four inside swivel pins
- With round bolts for safe mounting of the scaffold floors
- Steel tubes perforated for securing options by security pin
- Self-locking swivel pins for mounting back guard rails and diagonal braces

Height (m)	Width (m)	Weight (kg)	PU (pcs.)	Article no.	Price (€)
2,00	0,74	16,70	25	000649	104,40
2,00	1,10	22,00	25	000601	138,70

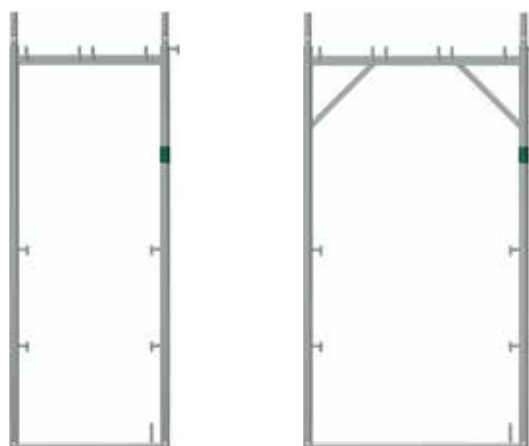





### TUBE CONNECTOR

Molded tube connector with slim collar for high load-bearing capacity and at the same time optimized stackability.



### RAIL HOUSINGS

Guard rail support with new, improved wedge geometry for secure positive and non-positive reception of up to two back guard rails.



### TOE BOARD HOLDER

Integrated deck fastening protection with toe board holder. Position and geometry ensure a reliable of the lift-off preventer of scaffold decks.

## ASSEMBLY FRAME ALUMINUM



- Aluminum tube  $\varnothing$  48.3 mm
- With round bolts for safe mounting of the scaffold floors
- Steel tubes perforated for securing options by security pin
- Self-locking swivel pins for mounting back guard rails and diagonal braces

Height (m)	Width (m)	Weight (kg)	PU (pcs.)	Article no.	Price (€)	
0,50	0,74	4,20	50	000254	112,30	⌚
1,00	0,74	5,80	50	000253	123,40	
1,50	0,74	7,50	25	000268	130,60	⌚
2,00	0,74	8,70	25	000252	147,70	



## ASSEMBLY FRAME STEEL 1-BOARD



- Steel tube  $\varnothing$  48.3 mm, hot dip galvanized
- With round bolts for safe mounting of the scaffold floors
- Steel tubes perforated for securing options by security pin
- Self-locking swivel pins for mounting back guard rails and diagonal braces

Height (m)	Width (m)	Weight (kg)	PU (pcs.)	Article no.	Price (€)	
1,00	0,40	9,50	50	000271	87,80	⌚
2,00	0,40	14,50	25	000270	100,30	



## ASSEMBLY FRAME FOR ROOF OVERHANG



- Steel tube  $\varnothing$  48.3 mm, hot dip galvanized
- For converting roof overhangs and building protrusions

Height (m)	Width (m)	Weight (kg)	PU (pcs.)	Article no.	Price (€)	
2,00	0,74	20,60	25	000276	132,40	
2,00	1,10	23,50	25	000277	143,60	⌚



## CONVERSION FRAME



- Steel tube  $\varnothing$  48.3 mm, hot dip galvanized
- Enables conversion from a 1-board scaffold frame into a UNI 70 scaffold



Height (m)	Width (m)	Weight (kg)	PU (pcs.)	Article no.	Price (€)
2,00	0,74/0,40	18,00	25	000278	131,10

## ROOFGUARD FRAME



- Steel tube  $\varnothing$  48.3 mm, hot dip galvanized
- For expanding the UNI 70 scaffold by one board width
- Particularly suitable for the erection of roof guard scaffolds as per DIN 4420
- Option of using as an adaptor frame when converting from UNI 70 to UNI 100



Height (m)	Width (m)	Weight (kg)	PU (pcs.)	Article no.	Price (€)
2,00	1,10/0,74	21,50	25	000281	141,10

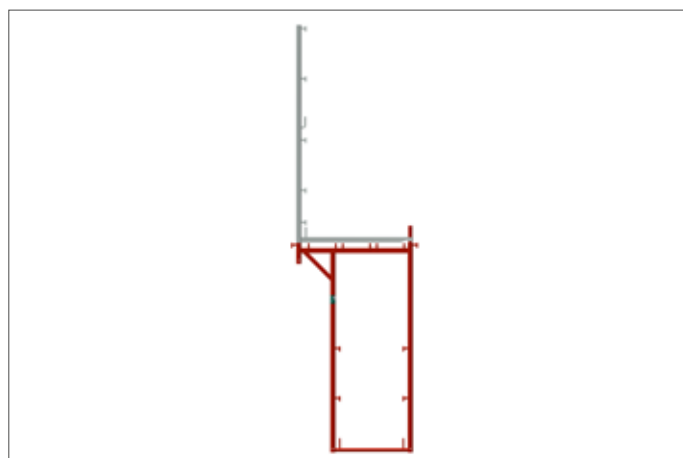
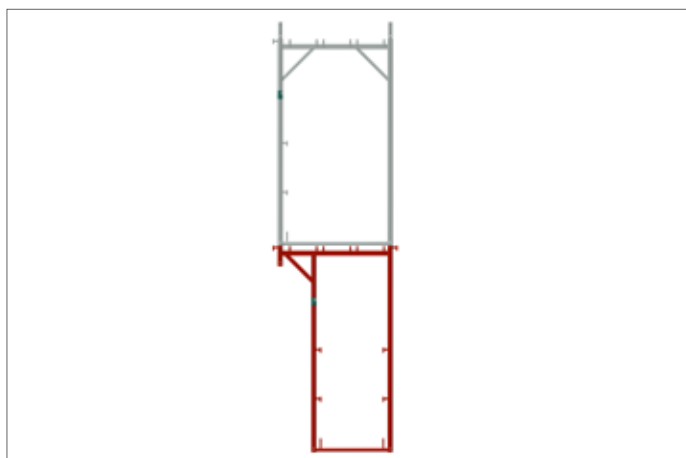

**WALK-TROUGH FRAME TRUSS BEAM**



- Steel tube Ø 48.3 mm, hot dip galvanized
- With tube connector
- With each four machine screws with nut
- Wide passageway for pedestrians and pedestrian protection in the lowest scaffold level



Model	Width (m)	Weight (kg)	Article no.	Price (€)
4-board	1,50	18,50	000043	167,90
5-board	1,80	22,00	000045	195,20

**WALK-TROUGH FRAME STANDARD**



- Steel tube Ø 48.3 mm, hot dip galvanized
- Suitable for walk-trough frame truss beam

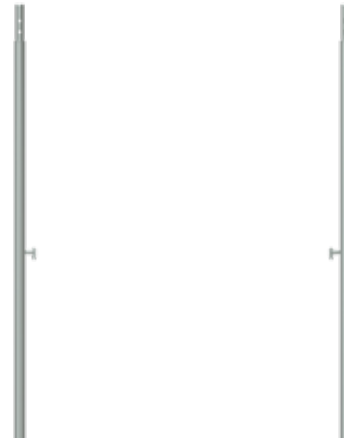

Height (m)	Weight (kg)	Article no.	Price (€)
2,00	7,50	000046	49,80

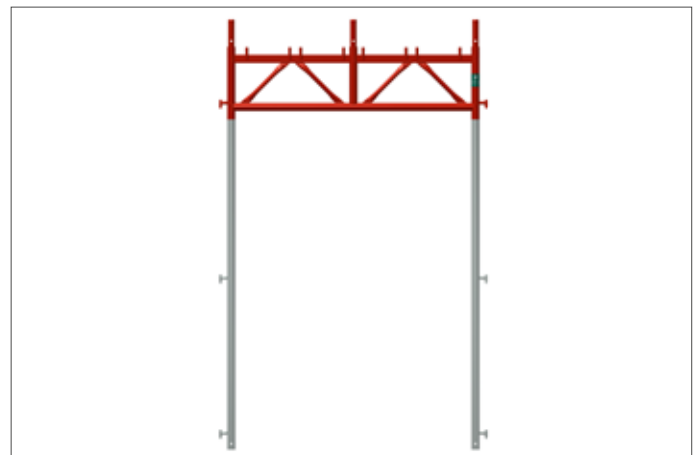
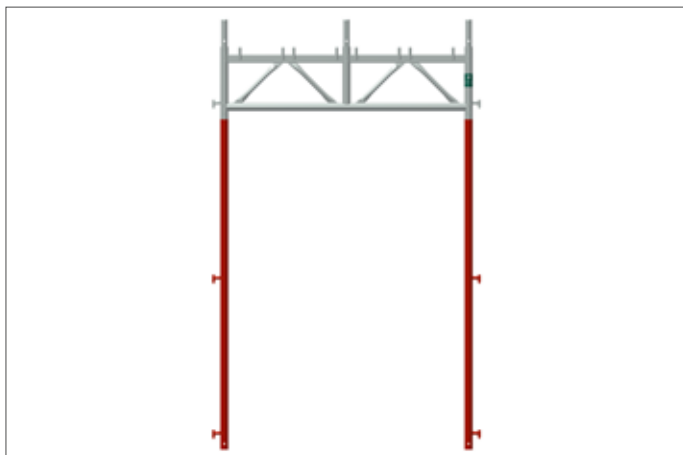

## TIMBER DECK 0.32 M



- Timber, 48 mm thick
- With hot dip galvanized deck caps
- Can be used on both sides
- Mechanically checked in accordance with DIN EN 14801 and DIN 4074 MS 10/13
- Waterproofed and weatherproof glued
- Can be used in guard and roof guard scaffolds as per DIN 4420 up to  $L \leq 3.00$  m



Length (m)	Width (m)	Weight (kg)	Load class	PU (pcs.)	Article no.	Price (€)
0,74	0,32	6,00	6	60	000176	44,00
1,10	0,32	8,50	6	60	000175	52,00
1,50	0,32	11,50	6	60	000035	58,40
2,00	0,32	14,50	5	60	000034	66,90
2,50	0,32	18,20	4	60	000032	75,50
3,00	0,32	22,00	3	60	000030	85,30



## STEEL DECK OPTI-LINE 0.32 M



- Steel, hot dip galvanized
- Non-slip surface through pronounced hole profiling
- Up to 3.4 kg lighter with the same load class
- Good stackability
- With handles for length 2.50 m



Length (m)	Width (m)	Weight (kg)	Load class	PU (pcs.)	Article no.	Price (€)
0,74	0,32	5,30	6	60/80	008840	68,30
1,10	0,32	7,30	6	60/80	008841	70,30
1,50	0,32	10,80	6	60/80	008843	79,90
2,00	0,32	13,20	6	60/80	008844	89,30
2,50	0,32	15,90	5	60/80	008845	97,80
3,00	0,32	19,25	4	60/80	008846	111,60

**STRONGER DUE  
TO NEW SURFACE**



## STEEL DECK 0.15 M



- Steel, hot dip galvanized
- Extremely robust, for the toughest operations
- Bracket deck for scaffold widening with 1/2 deck width, e.g. for WDVS work
- Compensating deck to close gaps in platform scaffolding
- Good stackability
- Also fits in the main scaffold instead of the standard decks



Length (m)	Width (m)	Weight (kg)	Load class	PU (pcs.)	Article no.	Price (€)
0,74	0,15	4,00	3	102	013271	70,90
1,10	0,15	5,00	3	102	013273	74,20
1,25	0,15	5,80	3	102	013274	78,70
1,50	0,15	6,70	3	102	013275	79,90
2,00	0,15	8,50	3	102	013276	91,90
2,50	0,15	10,30	3	102	013277	114,90
3,00	0,15	12,10	3	102	013278	121,40

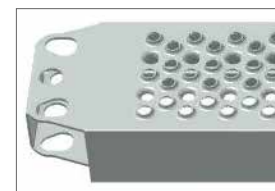

## ALUMINUM DECK WITH STEEL CAPS



- Non-slip surface and easy to stack
- Optimized ratio of weight and carrying through computerassisted profile optimization
- Steel caps, therefore robust and durable
- Patented beam reinforcements in the walking area ensure minimal deflection and best possible slip resistance



Length (m)	Width (m)	Weight (kg)	Load class	PU (pcs.)	Article no.	Price (€)
0,74	0,64	8,13	6	18	007009	167,50
1,10	0,64	10,58	6	18	007012	181,50
1,50	0,64	11,05	6	18	007015	208,70
2,00	0,64	14,45	6	18	007016	255,90
2,50	0,64	17,80	5	18	007017	305,20
3,00	0,64	21,20	4	18	007018	351,10
4,00	0,64	31,30	3	18	009265	495,30

## ALUMINIUMBODEN



- Beidseitig einsetzbar und rutschhemmend
- Kastenprofil mit fünf tragenden Längsstege
- Robuste Ausführung mit hoher Tragfähigkeit



Länge (m)	Breite (m)	Gewicht (kg)	LK	VPE (Stk.)	Art.-Nr.	Preis (€)
0,74	0,32	3,25	6	60	009636	112,00
1,10	0,32	4,70	6	60	016110	120,00
1,50	0,32	6,20	6	60	000317	126,00
2,00	0,32	8,00	6	60	000316	147,70
2,50	0,32	9,90	5	60	000315	177,20
3,00	0,32	11,80	4	60	000313	202,10
4,00	0,32	16,00	3	60	000310	370,80



## DECK CONNECTOR



- Steel, hot dip galvanized
- For connecting two aluminum decks
- Only required for 4.00 m aluminum decks



Weight (kg)	Article no.	Price (€)
0,10	000311	13,20

**YOU CAN FIND MORE DECKS FOR SPECIAL SOLUTIONS ON PAGE 39.**

## ACCESS DECK WITH PLYWOOD PANEL



- With water-resistant, non-slip and lightweight plywood panels 12 mm, BFU-100 G-12
- With integrated aluminum ladder
- Access flap open to the side

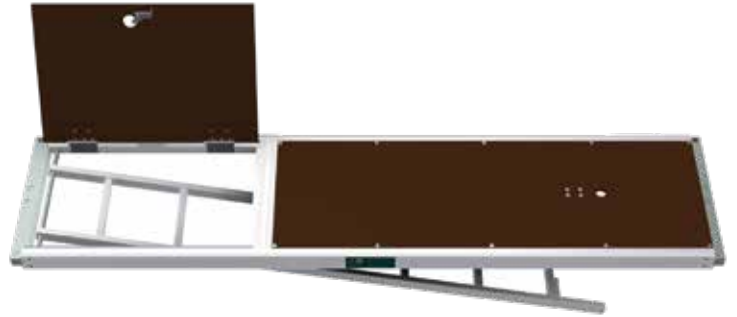

Length (m)	Width (m)	Weight (kg)	Load class	PU (pcs.)	Article no.	Price (€)
2,50	0,63	25,00	3	14	000388	387,20
3,00	0,63	28,00	3	14	000387	439,70

## ACCESS DECK WITH ALUMINUM DECK



- With non-slip deck aluminum
- Weather resistant, light and robust
- With integrated aluminum ladder (at length 2.00 m extendable)
- Access flap made of corrugated sheet metal, open to the side



Length (m)	Width (m)	Weight (kg)	Load class	PU (pcs.)	Article no.	Price (€)
2,00	0,63	19,00	4	14	000391	418,30
2,50	0,63	22,50	4	14	000389	426,60
3,00	0,63	25,00	3	14	000390	469,30



## ACCESS DECK WITH ALUMINUM DECK WITHOUT LADDER



- With non-slip deck aluminum
- Weather resistant, light and robust
- Without integrated ladder
- Access flap made of corrugated sheet metal, open to the side



Length (m)	Width (m)	Weight (kg)	Load class	PU (pcs.)	Article no.	Price (€)	
1,50	0,63	15,00	4	14	008496	275,60	🕒
2,00	0,63	17,00	4	14	003153	311,80	🕒

## ACCESS LADDER



- As a separate ladder for the inside scaffold ascent
- With riveted claws for safe mounting to the access decks



Model	Length (m)	Width (m)	Weight (kg)	PU (pcs.)	Article no.	Price (€)
Aluminium	2,16	0,40	3,00	–	001323	80,70
Steel	2,16	0,40	10,50	80	000172	79,90



## DIAGONAL BRACE



- Steel tube Ø 48.3 mm, hot dip galvanized
- The assembly takes place on the outside of the scaffold using the upper swivel pin on the vertical frame
- The arrangement of the diagonal guarantees a vertical framework construction, floor level alignment is not required



Field (m)	Length (m)	Weight (kg)	PU (pcs.)	Article no.	Price (€)
1,50	2,50	7,50	50	000082	31,50
2,00	2,83	8,00	50	000081	34,10
2,50	3,20	9,50	50	000080	36,80
3,00	3,61	11,00	50	000079	40,70
4,00	4,53	13,80	50	000231	52,40

## LOWER DIAGONAL FASTENER



- Steel, hot dip galvanized
- For fastening the diagonal braces at ground level
- For each diagonal bay, two lower diagonal fasteners and one back guard rail are required as a horizontal ledger



Weight (kg)	Article no.	Price (€)
0,50	000089	8,10

## CROSS DIAGONAL



- Steel, hot dip galvanized
- With two half couplers
- For power full bracing assembly frame vertical to the facade and for supporting brackets

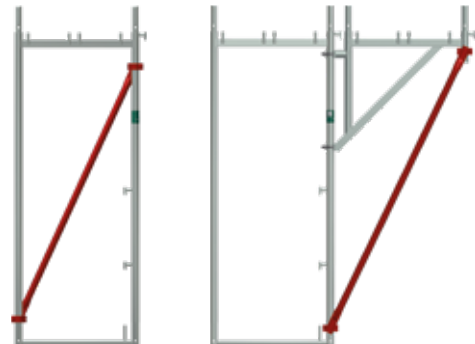

Model	Length (m)	Weight (kg)	A/F	Article no.	Price (€)
2-board	1,77	5,30	19	000588	53,10
3-board	1,95	5,80	19	000587	55,90

**GUARD RAIL** 

- Steel tube Ø 38 mm, hot dip galvanized
- Compressed and perforated at the ends
- Time-saving attachment via the self-locking swivel pins
- No tools required for installation



Length (m)	Weight (kg)	PU (pcs.)	Article no.	Price (€)
0,74	1,40	100	011937	17,10
1,10	2,00	100	011939	17,80
1,25	2,30	100	011940	19,70
1,50	2,80	100	011941	19,10
2,00	3,60	100	011942	19,70
2,50	4,50	100	011943	21,00
3,00	5,40	100	011944	23,00
4,00	11,80	100	007822	47,30

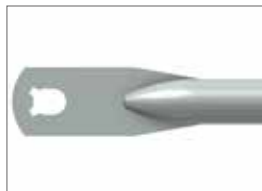

**INSIDE GUARD RAIL POST WITH TOE BOARD PIN** 

- Steel, hot dip galvanized
- With two welded swivel pins for attaching additional inner back guard rail to the vertical frame
- Quick installation with wedge lock

Length (m)	Weight (kg)	PU (pcs.)	Article no.	Price (€)
0,99	2,60	100	006136	47,30



**CORNER SWIVEL PIN**

- Steel, hot dip galvanized
- For mounting the side protection in corner areas
- Tool-free installation



Gewicht (kg)	Art.-Nr.	Preis (€)
0,30	011248	14,40

## TOE BOARD



- Timber
- Galvanized steel fittings
- To complete the three-part side protection in conjunction with UNI decks
- Easy mounting on the toe board bolts of the deck fasteners

Length (m)	Width (m)	Weight (kg)	PU (pcs.)	Article no.	Price (€)
0,74	0,15	2,00	80	000186	18,70
1,10	0,15	2,50	80	000184	19,00
1,50	0,15	3,00	80	000071	19,60
2,00	0,15	4,50	80	000070	20,80
2,50	0,15	5,50	80	000069	22,80
3,00	0,15	6,50	80	000066	24,20



**INDIVIDUAL COLOR AND PRINT ON REQUEST**

## ALUMINUM TOE BOARD



- Aluminum
- Galvanized steel fittings
- For attaching onto the toe board pins of the vertical frame as a part of the complete three-part side protection

Length (m)	Width (m)	Weight (kg)	PU (pcs.)	Article no.	Price (€)
0,74	0,15	1,50	80	010161	34,40
1,10	0,15	2,00	80	010162	40,00
1,50	0,15	2,70	80	010163	48,20
2,00	0,15	3,50	80	010164	56,60
2,50	0,15	4,30	80	010165	64,30
3,00	0,15	5,10	80	010166	72,90
4,00	0,15	6,70	80	015002	98,00



## END TOE BOARD



- Holz
- Stahlbeschläge verzinkt
- Für den stirnseitigen Seitenschutz

Length (m)	Weight (kg)	PU (pcs.)	Article no.	Price (€)
0,74	1,50	100	000073	18,80
1,10	2,00	100	000074	19,90



## TOP END GUARD FRAME



- Steel tube Ø 48.3 mm, hot dip galvanized
- Double side guards and deck fastening for the top scaffold platform



Width (m)	Weight (kg)	PU (pcs.)	Article no.	Price (€)
0,74	9,70	25	000064	78,60
1,10	13,80	25	000065	91,20

## GUARD RAIL POST WITH DECK FASTENER



- Steel tube Ø 48.3 mm, hot dip galvanized
- For mounting back guard rail and fastening scaffold decks to the top scaffold platform

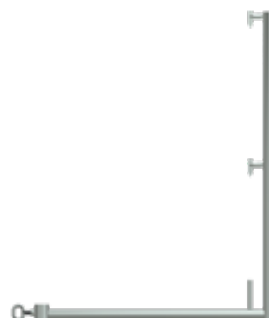

Höhe (m)	Breite (m)	Gewicht (kg)	VPE (Stk.)	Art.-Nr.	Preis (€)
1,00	0,74	5,00	50	000077	45,90
1,00	1,10	6,50	50	000078	47,90

## SINGLE GUARD RAIL POST



- Steel tube Ø 48.3 mm, hot dip galvanized
- For mounting back guard rails on the top scaffold platform



Height (m)	Weight (kg)	PU (pcs.)	Article no.	Price (€)
1,00	3,50	50	000075	30,90

## GUARD RAIL POST



- Steel tube Ø 48.3 mm, hot dip galvanized
- With short deck fastener and toe board pin
- Without tube connector



Height (m)	Weight (kg)	PU (pcs.)	Article no.	Price (€)
1,00	4,00	50	000630	38,10

## GUARD RAIL POST WITH TUBE CONNECTOR



- Steel tube Ø 48.3 mm, hot dip galvanized
- With short deck fastener and toe board pin
- With tube connector



Height (m)	Weight (kg)	PU (pcs.)	Article no.	Price (€)
1,00	4,50	50	000398	44,00

## GUARD RAIL FOR ROOF GUARD



- Steel tube Ø 48.3 mm, hot dip galvanized
- For securing the top deck level and fastening roof guard nets
- In conjunction with guard rails also suitable for the installation of side protection and roof safety net
- Approved for the setting up of guard and roofguard scaffolds as per DIN 4420



Height (m)	Width (m)	Weight (kg)	PU (pcs.)	Article no.	Price (€)
2,00	0,74	10,00	50	000140	107,00
2,00	1,10	12,00	50	000244	109,90

## GUARD RAIL POST 2.00 M



- Steel tube  $\varnothing$  48.3 mm, hot dip galvanized
- With short deck fastener and tube connector
- ATTENTION: Its use in guard and roof guard scaffolds is not permitted!



Height (m)	Weight (kg)	PU (pcs.)	Article no.	Price (€)
2,00	8,00	50	000245	82,20

## REINFORCEMENT FOR ROOF RAIL



- Steel, hot-dip galvanized
- With three half couplers
- To reinforce the guard rail post for roof guard for a bay length of 4.00 m

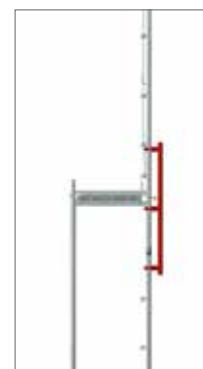

Height (m)	A/F	Weight (kg)	Article no.	Price (€)
1,30	22	7,50	010063	55,00

## SINGLE END GUARD RAIL



- Steel tube  $\varnothing$  33.7 mm, hot dip galvanized
- With welded half coupler
- To be used in pairs as double side guardsa



Width (m)	Weight (kg)	A/F	PU (pcs.)	Article no.	Price (€)
0,74	2,00	22	25	000059	25,40
1,10	3,00	22	25	000060	27,20

## DOUBLE END GUARD RAIL



- Steel tube  $\varnothing$  33.7 mm, hot dip galvanized
- Double side guards at the ends
- Connected on one side of the swivel pin and attached to the opposite side



Width (m)	Weight (kg)	A/F	PU (pcs.)	Article no.	Price (€)
0,74	3,00	22	25	000061	40,00
1,10	4,00	22	25	000062	45,40

## WALL TIE



- Steel tube  $\varnothing$  48.3 mm, hot dip galvanized
- Installation as short scaffold tie with one standard coupler
- Installation as long scaffold tie with two standard couplers

Length (m)	Weight (kg)	Article no.	Price (€)
0,30	1,40	000240	13,00
0,40	1,80	000242	14,40
0,50	2,00	000125	15,10
0,60	2,60	000241	16,40
0,80	3,20	000129	18,40
1,00	3,80	000127	20,40
1,30	4,80	000131	21,40
1,50	5,50	000132	24,70



## WALL TIE WITH PLATE



- Steel tube  $\varnothing$  48.3 mm, hot dip galvanized
- Installation with a standard coupler

Length (m)	Weight (kg)	Article no.	Price (€)
0,70	2,70	000124	23,30



## WALL TIE



- Steel tube  $\varnothing$  48.3 mm, hot dip galvanized
- Hook is welded at the inside
- Enables optimised connection of scaffold couplers close to the facade in conjunction with ETICS anchor bridge



Length (m)	Weight (kg)	Article no.	Price (€)
0,18	0,95	009190	15,30

## ANCHOR BRIDGE THERMAL INSULATION COMPOSITE SYSTEM



- Set with WDVS bridge and two eye bolts
- For the anchoring of scaffolding to house walls, especially for WDVS
- Even with a lever arm of 28 cm a sufficient load capacity is guaranteed parallel to the house wall



Weight (kg)	Article no.	Price (€)
3,61	009141	84,60



## EYE BOLT Ø 12 MM

EN

- Galvanized and welded
- For use with plastic expansion plugs 70 / 100 mm and plastic caps natural / black

Length (m)	Thread Length (mm)	Weight (kg)	PU (pcs.)	Article no.	Price (€)
90	54	0,155	150	000358	1,50
120	65	0,175	150	000359	1,70
160	58	0,210	100	000360	1,90
190	65	0,235	100	000363	2,10
230	65	0,265	100	000361	2,20
300	65	0,300	50	002374	2,50
350	65	0,364	50	000362	2,70
400	65	0,424	50	006333	6,00
450	65	0,468	50	007555	6,20
500	65	0,530	50	002983	7,50



## EYE BOLT M12

EN

- Galvanized and welded
- With metric thread

Length (m)	Thread Length (mm)	Weight (kg)	PU (pcs.)	Article no.	Price (€)
60	35	0,140	150	012379	5,00
80	35	0,150	150	012383	5,10
100	35	0,160	100	012384	5,20
120	35	0,175	100	012385	5,40
160	35	0,210	100	012386	5,60
220	35	0,260	50	012387	5,90



## PLASTIC CAP



EN

- For closing anchor drill holes

Colour	Weight (kg)	PU (pcs.)	Article no.	Price (€)
natural	0,003	100	000651	0,20
black	0,003	100	010353	0,20



## EXPANSION PLUG



EN

- For eye bolts with a timber thread Ø 12 mm
- For drilling Ø 14 mm

Length (m)	Weight (kg)	PU (pcs.)	Article no.	Price (€)
0,07	0,007	100	000357	0,40
0,10	0,007	100	011158	0,40



## MJ-SCAFFY



- Screw-in aid for eye bolts
- With socket A/F 22 (for standard ratchet wrenches)
- With 3/4 inch square socket
- With SDS drill adapter



Weight (kg)	Article no.	Price (€)
0,374	012600	70,60

## BRACKET 0.32 M WITH TUBE CONNECTOR



- Stahl, feuerverzinkt
- Mit Rohrverbinder zur Aufnahme von Geländerstützen
- Mit angeschweißter Halbkupplung
- Zur Verbreiterung des Gerüsts nach innen oder außen mit einem Systembelag von 0,32 m Breite



Width (m)	Weight (kg)	A/F	PU (pcs.)	Article no.	Price (€)
0,32	5,10	22	25	000091	57,10

## BRACKET 0.32 M WITHOUT TUBE CONNECTOR



- Steel, hot dip galvanized
- Without tube connector
- With welded half coupler
- Easy to use with board securing



Width (m)	Weight (kg)	A/F	PU (pcs.)	Article no.	Price (€)
0,32	3,00	22	100	000092	44,00

## BRACKET 0,15 M



- Steel, hot dip galvanized
- Without tube connector
- With welded half coupler
- Easy to use with board securing
- Used to extend the scaffold on the inside by one 0.15 m wide system deck



Width (m)	Weight (kg)	A/F	PU (pcs.)	Article no.	Price (€)
0,15	1,80	22	25	013958	40,00

## BRACKET 0.64 M WITH TUBE CONNECTOR



- Steel, hot dip galvanized
- With tube connector
- With welded half coupler
- Used to widening the scaffold on the inside or outside by two system decks and to extend the ends



Width (m)	Weight (kg)	A/F	PU (pcs.)	Article no.	Price (€)
0,74	8,00	22	20	000094	79,90

## BRACKET 0.64 M WITHOUT TUBE CONNECTOR



- Steel, hot dip galvanized
- Without tube connector
- With welded half coupler
- Used to widening the scaffold on the inside or outside by two system decks and to extend the ends



Width (m)	Weight (kg)	A/F	PU (pcs.)	Article no.	Price (€)
0,64	6,30	22	20	004620	71,60

## BRACKET 0.74 M



- Steel, hot dip galvanized
- With two tube connectors
- Used to make scaffold lift adaptations of one UNI 70 vertical frame width
- Unlike 0.64 m the adaptation is not only possible at deck height, but can be made at any required height
- Used to widening the scaffold by two system decks and for mounting guard and roof guard scaffolds



Width (m)	Weight (kg)	A/F	PU (pcs.)	Article no.	Price (€)
0,74	10,00	22	20	000095	97,10

## BRACKET 0.96 M



- Steel, hot dip galvanized
- With tube connector
- With welded half coupler
- Used to widening the scaffold on the inside or outside by three system decks and to extend the ends
- Additional support through cross diagonals
- Stability of the supporting structure must be verified in each individual case

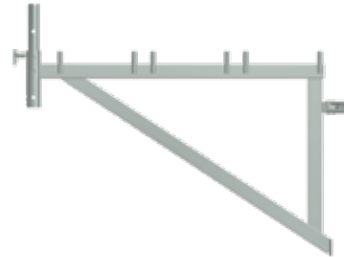

Width (m)	Weight (kg)	A/F	PU (pcs.)	Article no.	Price (€)
0,96	9,00	22	20	000099	104,40

## GRID BRACKET 0.50 M



- Steel, hot dip galvanized
- With tube connector
- With half coupler
- Used to extend or shorten scaffold bays



Width (m)	Weight (kg)	A/F	PU (pcs.)	Article no.	Price (€)
0,50	6,00	22	20	007129	56,10



## BRACKET 1.10 M



- Steel, hot dip galvanized
- With two tube connectors
- With welded half coupler
- For vertical frame UNI 100
- Additional support through cross diagonals
- Stability of the supporting structure must be verified in each individual case

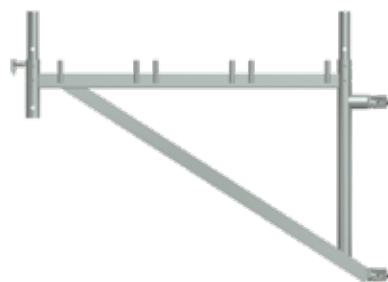

Width (m)	Weight (kg)	A/F	PU (pcs.)	Article no.	Price (€)
1,10	11,50	22	20	000096	119,40

**YOU WILL FIND BRACKETS ASPIRATIONS ON PAGE 17.**

## CORNER BRACKET WITHOUT TUBE CONNECTOR



- Steel, hot dip galvanized
- A welded half coupler at a staggered height enables two brackets to be connected to one stand tube

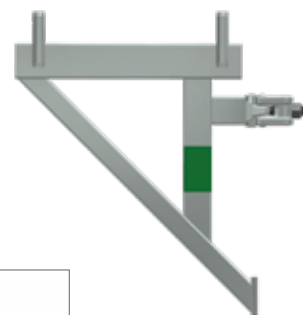

Width (m)	Weight (kg)	A/F	PU (pcs.)	Article no.	Price (€)
0,32	3,20	22	20	008218	60,00

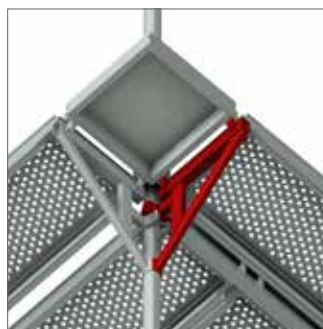
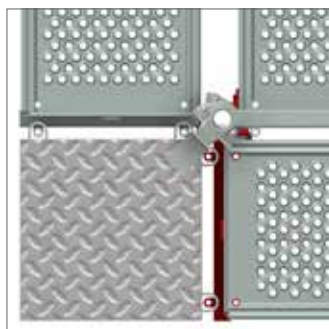

## CORNER DECK



- Steel, hot dip galvanized
- As an addition to system decks in the inner corner area
- Non-slip deck
- In conjunction with corner bracket
- For securing the deck, see page 19, art. No.: 006850

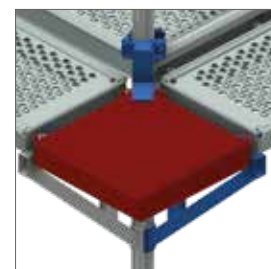

Length (m)	Width (m)	Weight (kg)	Article no.	Price (€)
0,32	0,32	7,00	008216	66,60

## ROOF GUARD EXTENSION



- Steel, hot dip galvanized
- For construction a roof guard as per DIN 4420
- To be used with deck fastener in conjunction with bracket 0.64 m with tube connector (Article no. 000094) or bracket 0.96 m (Article no. 000099)

Width (m)	Weight (kg)	Article no.	Price (€)
0,74	4,00	000143	40,10



## DECK FASTENER



- Steel, hot dip galvanized
- Suitable for roof guard extensions

Height (m)	Width (m)	Weight (kg)	A/F	Article no.	Price (€)
0,70	0,45	2,00	22	000246	52,40



## ALUMINUM STAIR WITH PLATFORM



- Bay height 2.00 m
- Scaffold stairway for the planned construction with facade scaffoldings
- For quick and safe mounting of the scaffold levels
- The steps are designed in a non-slip manner and allow comfortable outside access for extensive use of scaffold and when transporting material, without reducing the work surface in the main walkway
- Evenly distributed area load  $p = 2.5 \text{ kN/m}^2$
- Single load distributed on  $0.2 \times 0.2 \text{ m}^2 F = 1.5 \text{ kN}$
- Meets the requirements according to DIN EN 12811-1



Field height (m)	Length (m)	Width (m)	Weight (kg)	PU (pcs.)	Article no.	Price (€)
2,50	3,25	0,64	22,50	10	000417	549,90
3,00	3,60	0,64	33,00	10	000418	609,90

Individual customer identification possible.



## OUTSIDE STAIRCASE HANDRAIL



- Steel, hot dip galvanized
- For aluminum platform stairs
- For mounting on swivel pins

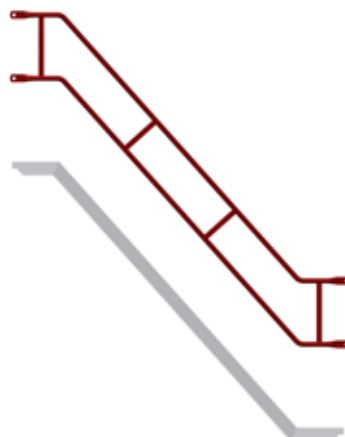

Field (m)	Length (m)	Weight (kg)	PU (pcs.)	Article no.	Price (€)
2,50	3,45	16,00	40	000426	150,90
3,00	3,60	16,50	40	011120	164,10

## INSIDE STAIRCASE HANDRAIL



- Steel, hot dip galvanized
- For aluminum platform stairs
- Can be used for field wide 2.50 and 3.00 m
- For mounting to the stair string
- Integrated end plug on the handrail for protection



Length (m)	Weight (kg)	A/F	PU (pcs.)	Article no.	Price (€)
2,25	11,50	19	20	000425	137,80
2,25	11,50	22	20	006942	137,80

## ROUND INSIDE GUARD RAIL



- Steel, hot dip galvanized
- For aluminum platform stairs
- For mounting to the stair string

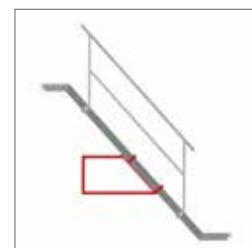

Weight (kg)	A/F	Article no.	Price (€)
5,80	19	009226	69,60



## GAP COVER WITH HALF COUPLER



- Steel, hot dip galvanized
- Non-slip deck
- Varied use for bridging gaps up to 0.25 m wide
- Quick assembly due to half coupler

Length (m)	Width (m)	Weight (kg)	A/F	Article no.	Price (€)
0,35	0,38	4,00	22	007794	45,80
0,60	0,38	6,20	22	008256	71,60

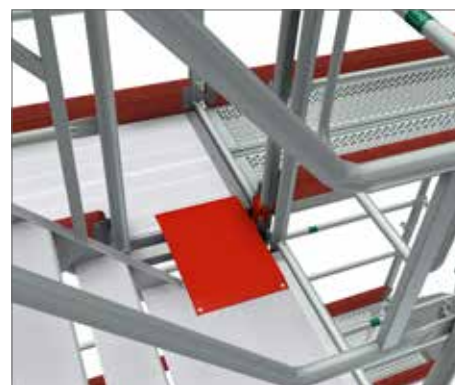

## STAIR GAP DECK



- Steel, hot dip galvanized
- Tool-free assembly thanks to support on two scaffolding frames
- Seamless transition between main decking and platform stairs
- Use with distance coupler 114 mm (Art. no. 004758)



Length (m)	Width (m)	Weight (kg)	Article no.	Price (€)
2,50	0,19	13,70	014631	120,00
3,00	0,19	16,01	014632	130,00

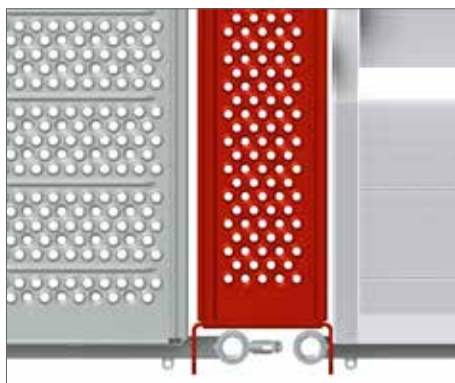

**DISTANCE COUPLER**

- Steel tube Ø 48.3 mm
- With two welded couplers, galvanized
- E. g. as connection between facade scaffold and a forward-placed stair ascent

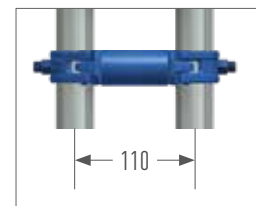

Width (m)	A/F	Weight (kg)	Article no.	Price (€)
0,180	22	1,80	004758	41,00

**GRIDDOOR**



- Complete protection against unauthorised access to stairways
- Visible separation between construction site and surroundings
- Assembly and fixing thanks to sliding coupling connection points
- Mesh door for all scaffolding widths thanks to flexible coupling connections

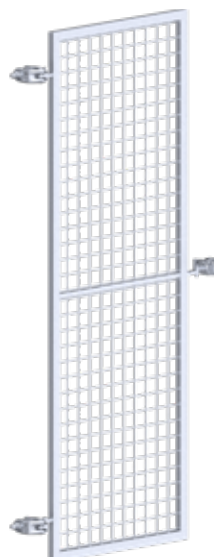

Height (m)	Width (m)	Weight (kg)	Article no.	Price (€)
1,70	0,85	13,00	014603	179,00

**GUARD RAIL BRACKET FOR PLATFORM STAIRS**



- Steel, galvanized
- With tube connector
- With welded half coupler
- Reduces the guard rail width by 0.50 m, e. g. from 2.57 to 2.07 m to make the passage to the stairs



Length (m)	Weight (kg)	A/F	Article no.	Price (€)
0,50	3,20	19	008227	49,20

## STEP ACCESS PLATFORM



- Steel, hot dip galvanized
- Non-slip deck
- With two tube connectors, axial dimension 175 mm
- With two welded couplers
- To set up a stairway in front of a scaffold field
- Reduces the guard rail width by 0.50 m, e.g. from 2.50 to 2.00 m to create the passage to the stairs



Length (m)	Width (m)	Weight (kg)	A/F	PU (pcs.)	Article no.	Price (€)
0,50	0,30	7,50	22	14	000234	91,80

## ALUMINUM BEGINNING STAIRS WITH PLATFORM



ID

- Beginning stair with integrated base jack mounts
- Scaffold stairway for the planned construction with facade scaffolding
- For quick and safe mounting of the scaffold levels
- The steps are designed in a non-slip manner and allow comfortable outside access for extensive use of scaffold and when transporting material, without reducing the work surface in the main walkway



Field height (m)	Length (m)	Width (m)	Weight (kg)	PU (pcs.)	Article no.	Price (€)
0,50	0,91	0,64	9,00	10	015203	326,10
1,00	1,50	0,64	10,70	10	000395	334,70
1,50	1,75	0,64	19,00	15	009944	458,50



## STAIR GUARD RAIL



- Steel, hot dip galvanized
- For aluminum beginning stair with platform 1.00 m / 1.50 m
- For easy installation on protruding threaded rods  
incl. connection with half-coupling



Weight (kg)	Article no.	Price (€)
11,50	014964	135,70

## ACCESS LADDER 1.00 M



- Steel, hot dip galvanized
- System-related suspension
- Enables easy entry into the scaffold, with a field height of 1.00 m



Length (m)	Width (m)	Weight (kg)	Article no.	Price (€)
0,90	0,74/0,45	7,60	010347	93,10



**TRANSOM** 

- Steel, hot dip galvanized
- Adjustable height for intermediate levels in the vertical frame
- When using bridging beams the system deck is mounted by using transoms

Width (m)	Weight (kg)	A/F	Article no.	Price (€)
0,74	4,00	22	000103	48,60
1,10	4,50	22	000105	68,90

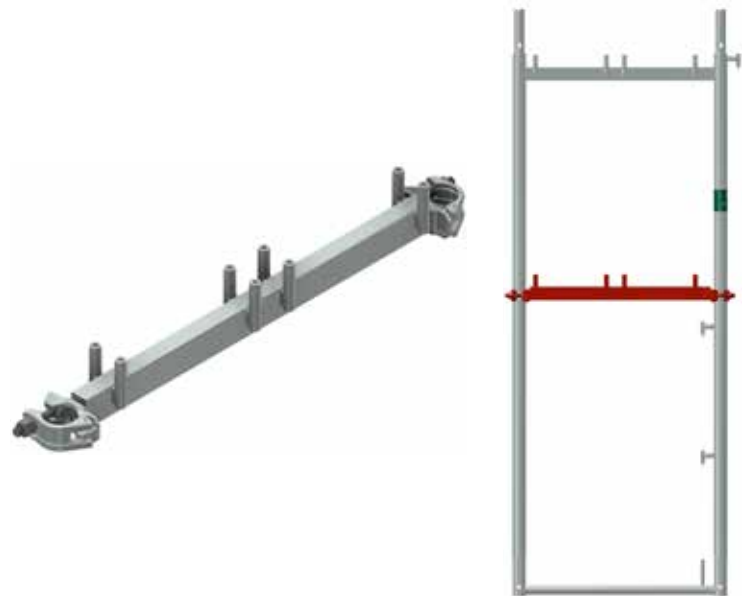

**PLATFORM TRANSOM** 

- Steel, hot dip galvanized
- But designed for building a continuous platform level between the scaffolds

Width (m)	Weight (kg)	A/F	Article no.	Price (€)
0,74	4,50	22	000106	60,40
1,10	5,00	22	000107	77,10

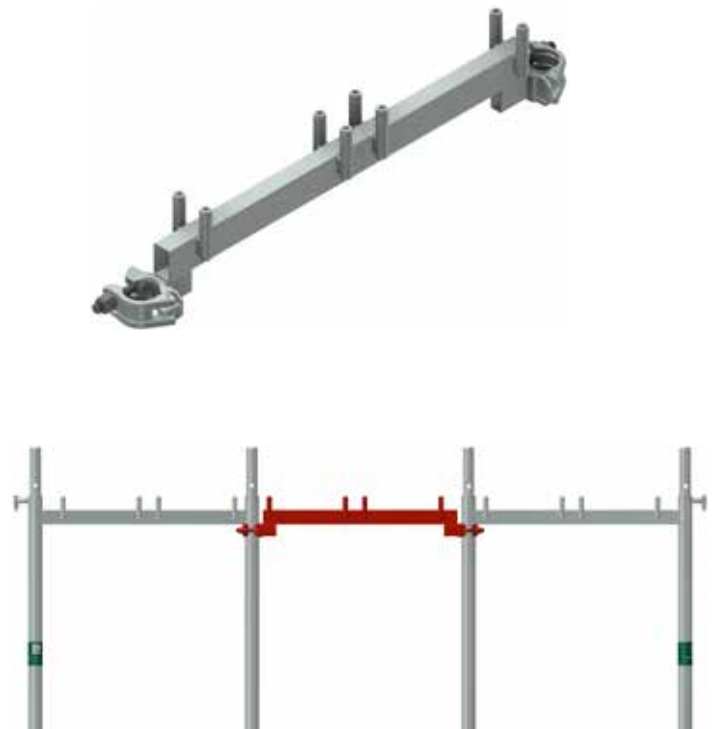

## HANGING TRANSOM



- Steel, hot dip galvanized
- For cantilevered end elevations and/or for bridging up to a 6.00 m span, in conjunction with diagonal braces and couplers with swivel pin

Width (m)	Weight (kg)	Article no.	Price (€)
0,74	6,00	000171	60,50
1,10	7,00	000218	71,80



## CONVERSION TRANSOM



- Steel, hot dip galvanized
- System change from UNI 100 to UNI 70 can be easily achieved

Width (m)	Weight (kg)	Article no.	Price (€)
1,13	5,70	012005	52,90

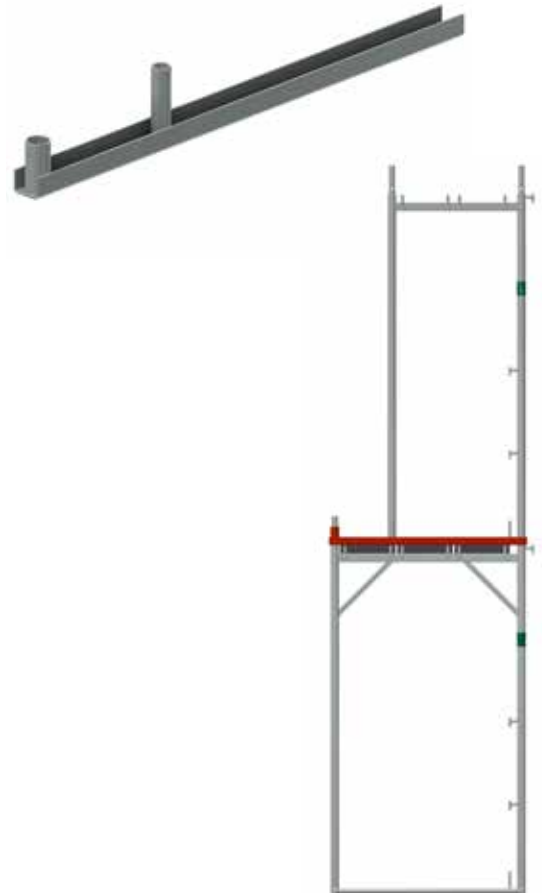

**DECK FASTENING WITH HALF COUPLER** 

- Steel, hot dip galvanized
- With welded half coupler
- For securing decks against lifting off



Weight (kg)	A/F	Article no.	Price (€)
1,10	19	008156	15,80
1,15	22	008157	15,80

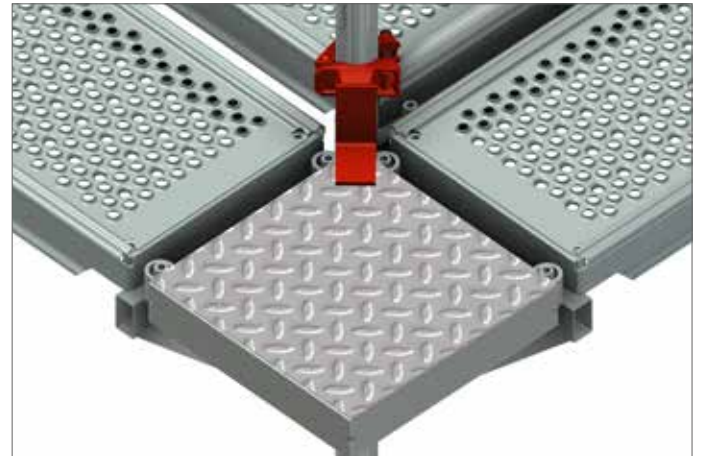
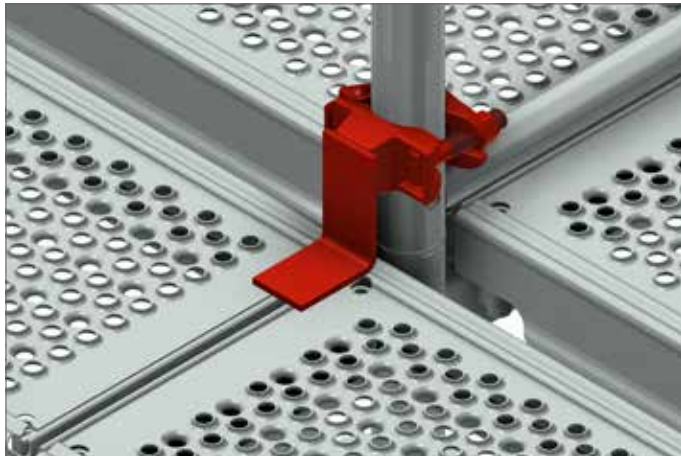

**DECK FASTENING WITH WEDGE** 

- Steel, hot dip galvanized
- With wedge head connection
- For securing decks against lifting off



Weight (kg)	Article no.	Price (€)
0,70	006850	14,60

## BRACKET DECK FASTENING



- Steel, hot dip galvanized
- For securing decks against lifting off



Width (m)	Weight (kg)	A/F	Article no.	Price (€)
0,40	1,50	22	007302	26,60



## BRACKET FASTENER



- Steel, hot dip galvanized
- Enables varied mounting of brackets in building niches
- Can be used with timber and steel decks



Width (m)	Weight (kg)	A/F	Article no.	Price (€)
0,40	1,50	22	000100	34,30

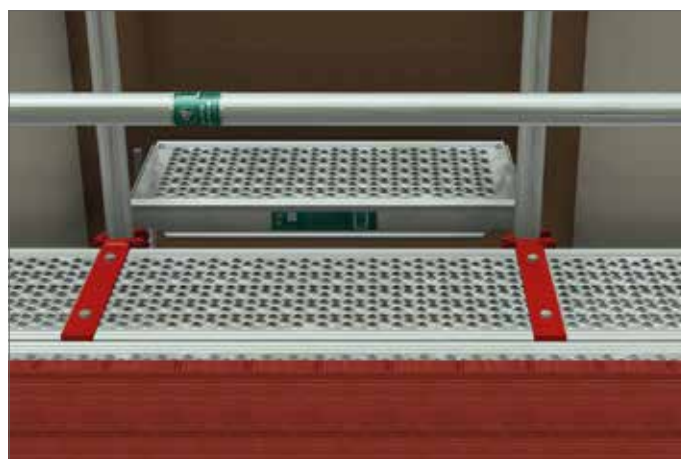

**GAP COVER ALUMINUM** 

- With plastic cap
- For gap cover between main and console field (5,5 cm - 11,3 cm)
- ATTENTION: floor is to be secured against lifting!
- Deck fastening article no. 009240

Length (m)	Width (m)	Weight (kg)	Article no.	Price (€)
0,74	0,22	1,40	008631	35,40
1,10	0,22	2,00	008632	38,00
1,50	0,22	2,90	008633	45,60
2,00	0,22	4,00	008634	54,80
2,50	0,22	5,00	008635	63,60
3,00	0,22	6,00	008636	74,70

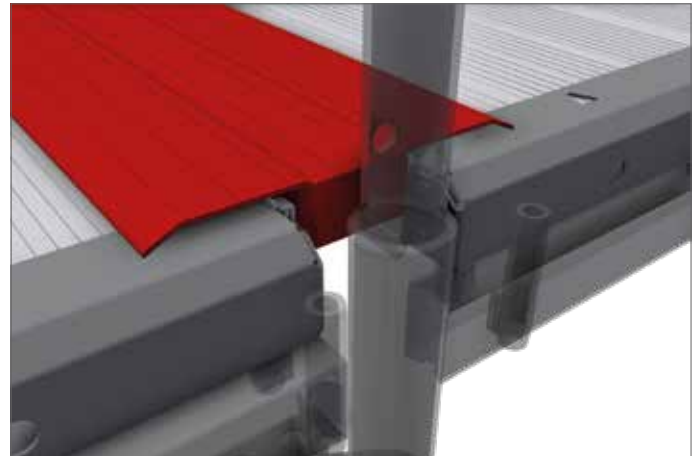

**DOUBLE DECK FASTENER** 

- Steel, hot dip galvanized
- For preventing decks and gap covers from lifting off

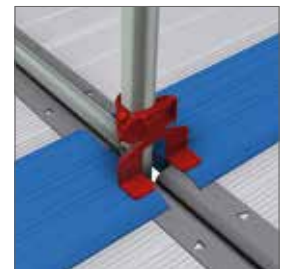

Weight (kg)	A/F	Article no.	Price (€)
1,00	22	009240	18,90



## GAP COVER



- Steel, hot dip galvanized
- Non-slip deck
- To cover gaps
- System-related suspension



Width (m)	Weight (kg)	Article no.	Price (€)
0,64	6,50	007904	59,70

## POLYGON COVERAGE 2-BOARD



- Steel, hot dip galvanized
- Non-slip deck with deck fastening for gap-free construction of round scaffolding from 0 to 50°



Width (m)	Weight (kg)	Article no.	Price (€)
0,61	8,50	007858	127,60

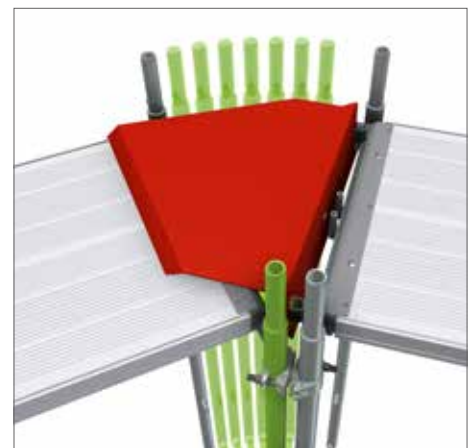

**FURTHER GAP COVERS CAN BE FOUND  
IN OUR PRICE LIST „ACCESSORIES“.**

END GUARD RAIL 1-BOARD



- Steel tube, hot dip galvanized
- Double side protection at the ends
- Plugged into each other
- Can be used for side protection on round scaffoldings



Weight (kg)	PU (pcs.)	A/F	Article no.	Price (€)
2,60	19	50	009366	29,20

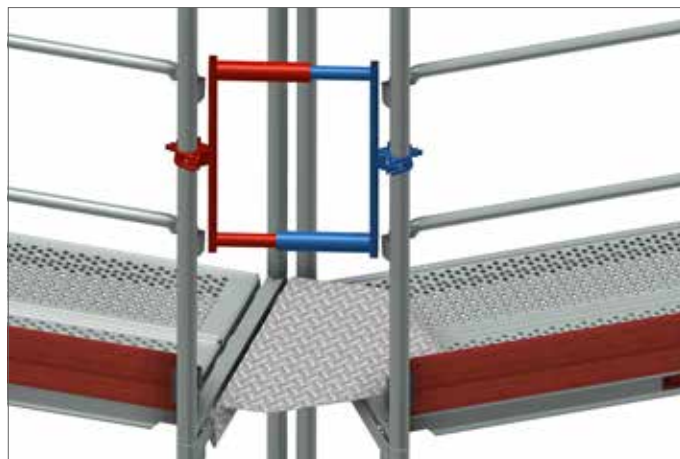
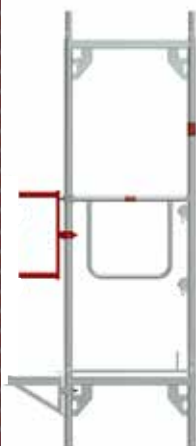

## ROOFER BRACKET



- Steel, hot dip galvanized
- With two tube connectors
- Meets different requirements for ergonomic workplaces for painters and tinsmiths
- Up to scaffold class 3
- Not to be used as a roof guard scaffold

Width (m)	Weight (kg)	A/F	PU (pcs.)	Article no.	Price (€)
0,74	15,00	22	12	000274	156,00

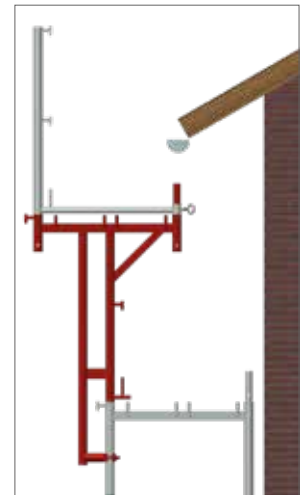
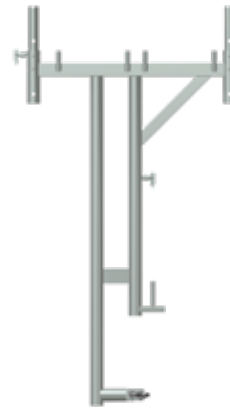

## CONSOL FRAME



- Steel, hot dip galvanized
- With two tube connectors
- For use at the eaves

Height (m)	Width (m)	Weight (kg)	PU (pcs.)	Article no.	Price (€)
1,00	0,74	14,60	20	010800	140,40

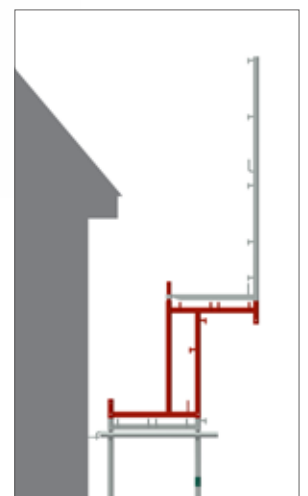
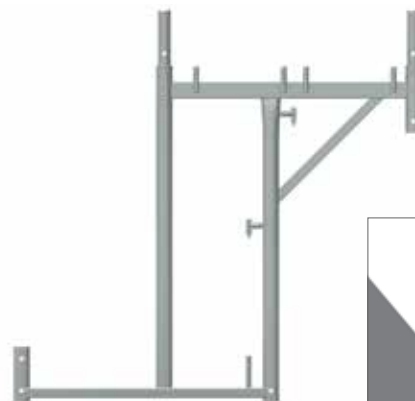

**RAIN CANOPY BRACKET TWO-PIECE SET** 

- Steel, hot dip galvanized
- For use with frame width 0.74 m in the top scaffold platform
- In conjunction with guard rails and tarps this component provides weather protection
- Guard rails page 18



Length (m)	Weight (kg)	Article no.	Price (€)
2,00	13,20	008259	182,00



**WEATHER PROTECTION POST** 

- Steel, hot dip galvanized
- With three swivel pins for fastening tarpaulins and tarp battens = back guard rails
- With connecting piece for guard rail posts

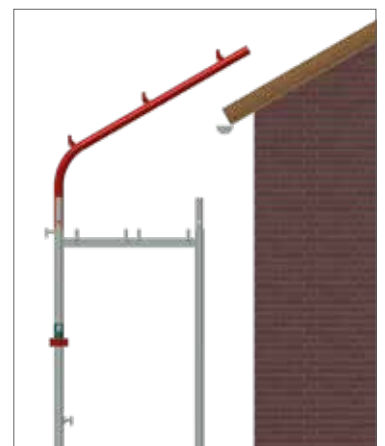

Width (m)	Weight (kg)	A/F	Article no.	Price (€)
2,00	12,00	22	000142	114,60

## ROLLING TOWER 1.70 M



- Steel, hot dip galvanized
- Suitable for mounting with scaffold parts of UNI 70
- Two eye bolts M 14 included

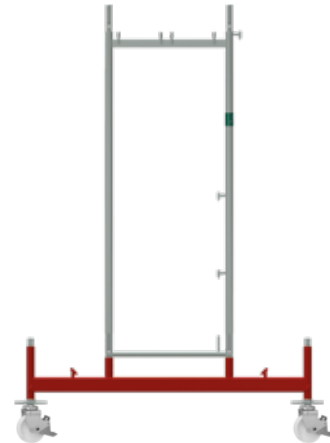

Length (m)	Weight (kg)	Article no.	Price (€)
1,70	19,00	000149	154,30

## ROLLING TOWER 3.00 M



- Steel, hot dip galvanized
- To be mounted as a mobile scaffold with scaffold parts UNI 100
- To be mounted as ceiling scaffold with scaffold parts UNI 70 and platform transoms 1.10 m
- Two eye bolts M 14 included



Length (m)	Weight (kg)	Article no.	Price (€)
3,00	29,00	000168	255,90

**SPINDLE SECURITY** 

- Steel, hot dip galvanized
- With half coupler
- Secures base jacks and swivel castors with spindle when moving scaffolding units with a crane

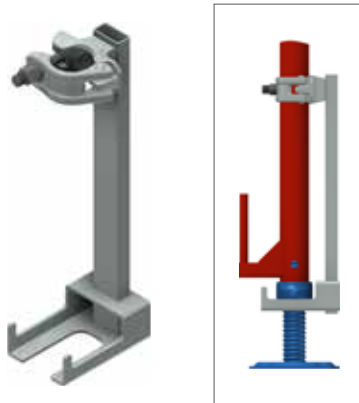

Height (m)	Weight (kg)	A/F	PU (pcs.)	Article no.	Price (€)
0,40	2,00	19	200	010294	30,20

**HEAD JACK**

- Steel, hot dip galvanized
- Supporting element for support and platform scaffolding as well as for formwork scaffolds
- Used to hold squares timbers, laminated beams and formwork beams



Opening dimension (mm)	Weight (kg)	PU (pcs.)	Article no.	Price (€)
148	5,60	200	000693	40,60
180	8,30	-	011537	49,90

**ADJUSTMENT TUBE** 

- Steel, hot dip galvanized
- Adjustment range 10 x 0.10 m = 1.00 m
- For levelling unequal ground
- Use in connection with a decking transom and base jack

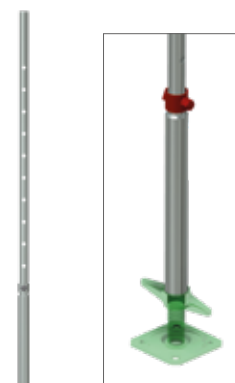

Height (m)	Weight (kg)	Article no.	Price (€)
1,70	5,80	000402	56,70

**CASTOR WITH SPINDLE** 

- Bearing 10 kN with central load distribution
- Castor Ø 200 mm made of polyamide with run stop
- Levelling through adjustable steel spindle
- The DIN 4420-3 applies when a rolling towers made of a scaffolding
- A standard proof of stability is required for this mobile scaffold



Weight (kg)	PU (pcs.)	Article no.	Price (€)
7,00	80	000332	102,50

**SECURITY PIN** 

- Steel, hot dip galvanized
- Ø 9 mm
- For securing the scaffold joints against unintentional lift-off



Weight (kg)	PU (pcs.)	Article no.	Price (€)
0,15	100	000508	1,40

## STANDARD COUPLER

EN

- Steel, hot dip galvanized, drop-forged
- Robust model
- For right-angled connection of tubes of  $\varnothing$  48.3 mm
- Class BB, EN 74-1
- To be used in the classes B and BB of the steel and aluminum tube

Thread	A/F	Weight (kg)	PU (pcs.)	Article no.	Price (€)
Standard	22	1,15	25	000325	8,60
Standard	19	1,15	25	000326	8,60
Quick	22	1,15	25	007521	9,30
Quick	19	1,15	25	007523	9,30



## SWIVEL COUPLER

EN

- Steel, hot dip galvanized, drop-forged
- Robust model
- For any angular connection of tubes of  $\varnothing$  48.3 mm
- Class B, EN 74-1
- To be used in the class B of the steel and aluminum tube

Thread	A/F	Weight (kg)	PU (pcs.)	Article no.	Price (€)
Standard	22	1,35	25	000328	9,30
Standard	19	1,35	25	000329	9,30
Quick	22	1,35	25	007522	9,90
Quick	19	1,35	25	007524	9,90



## SPARE PARTS CAN BE FOUND IN OUR PRICE LIST „ACCESSORIES“.

## SCAFFOLD TUBE STEEL

EN

- S235 Steel, hot dip galvanized
- Measurements as per EN 39
- Manufacturing length 6.00 m
- Minimum yield strength 235 N/mm<sup>2</sup>
- Connection of standard couplers allowed
- Special lengths on request

Model (mm)	Length (m)	Weight (kg)	PU (pcs.)	Article no.	Price (€)
48,3 x 3,2	1,00	3,77	61	004548	17,20
48,3 x 3,2	2,00	7,54	61	004550	31,40
48,3 x 3,2	3,00	11,31	61	004552	45,60
48,3 x 3,2	4,00	15,08	61	004554	61,80
48,3 x 3,2	5,00	18,85	61	005619	76,00
48,3 x 3,2	6,00	22,60	61	004087	85,00

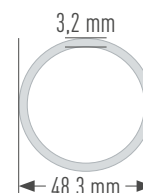

**SWIVEL PIN COUPLER** EN

- Steel, hot dip galvanized, drop-forged
- Half coupler with welded swivel pin for fixing additional back guard rails, e. g. on the inside of the scaffold



Thread	A/F	Weight (kg)	Article no.	Price (€)
Standard	22	0,80	000134	9,90
Standard	19	0,80	002354	9,90
Quick	22	0,81	007436	10,40
Quick	19	0,81	008202	10,40

**MORE COUPLERS  
FIND IN OUR  
PRICE LIST 'ACCESSORIES'**

**DISTANCE COUPLER** 🇩🇪

- Steel tube Ø 48.3 mm
- With two welded couplers, galvanized
- E. g. as connection between facade scaffold and a forward-placed stair ascent

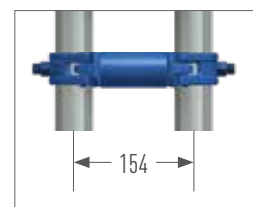

Width (m)	Weight (kg)	A/F	Article no.	Price (€)
0,110	1,60	22	008225	26,00
0,154	1,80	19	008297	26,30
0,180	2,00	22	000233	27,10



## LATTICE BEAM STEEL



- Steel tube  $\varnothing$  48.3 mm, hot dip galvanized
- Load depends on span according to the separate load table

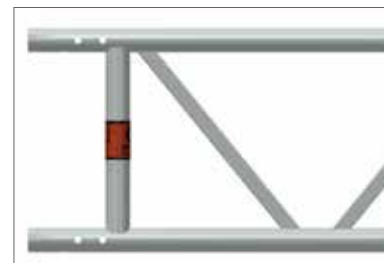

Length (m)	Height (m)	Weight (kg)	PU (pcs.)	Article no.	Price (€)
3,20	0,40	30,00	25	000108	198,50
4,20	0,40	39,00	25	000109	245,80
5,20	0,40	50,00	25	000110	297,80
6,20	0,40	58,00	25	000111	335,40
7,60	0,40	72,00	25	000112	496,30

## LATTICE BEAM ALUMINUM



- Aluminum tube  $\varnothing$  48.3 mm
- Load depends on span according to the separate load table



Length (m)	Height (m)	Weight (kg)	PU (pcs.)	Article no.	Price (€)
3,20	0,40	12,00	25	000255	234,00
4,20	0,40	15,00	25	000257	291,00
5,20	0,40	20,00	25	000258	348,00
6,20	0,40	23,00	25	000259	390,10
8,10	0,40	31,00	25	000261	550,00

## TUBE CONNECTOR FOR LATTICE BEAMS



- Steel, hot dip galvanized
- For the continuous extensions of lattice beams



Model	Weight (kg)	Article no.	Price (€)
Straight	1,30	003588	30,50

## BOLT WITH CUTTER PIN



EN

- Screw-free connection of lattice beams
- Replaces usual screws M 12 x 60 mm there by reducing the assembly time
- Consisting of cotter pin (article no. 002232), bolt (article no. 002235) and washer (article no. 002964)
- All articles are also available separately



Weight (kg)	Article no.	Price (€)
0,09	002237	3,70

**WALL CONNECTION FOR LATTICE BEAM** 

- Steel, hot dip galvanized
- For fastening to the wall, e. g. for bridging constructions
- For lattice beams with 400 mm construction height

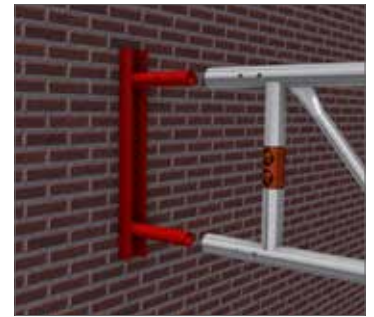

Weight (kg)	Article no.	Price (€)
3,50	000170	78,00

**DECK TRANSOM FOR LATTICE BEAMS** 

- Steel, hot dip galvanized



Model	Width (m)	Weight (kg)	A/F	Article no.	Price (€)
2-board	0,70	2,70	22	000216	49,20
3-board	1,00	4,70	22	000207	65,60
4-board	1,30	6,00	22	000210	85,30
5-board	1,60	7,50	22	000211	104,90
6-board	1,95	9,00	22	000212	124,70
7-board	2,25	9,80	22	000213	147,10
8-board	2,55	11,30	22	000214	167,10

## FURTHER ACCESSORIES FOR LATTICE BEAMS YOU CAN FIND IN OUR PRICELIST 'ACCESSORIES'



## DECK LEDGER FOR LATTICE BEAMS



- Steel, hot dip galvanized
- For mounting a UNI vertical frame and decks in conjunction with universal lattice beams, e. g. for bridging
- The lattice beams are arranged on the outside of the frame
- The ledger can be slid into position from its secured place by means of the deck

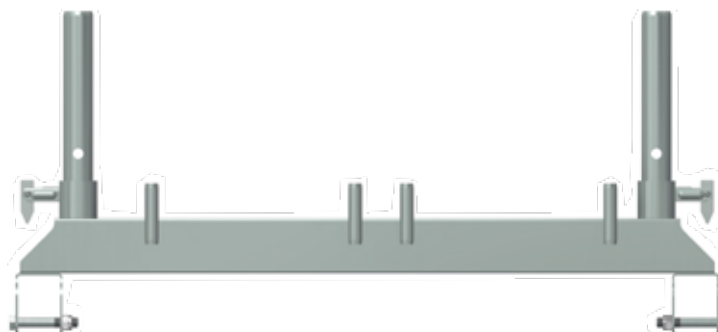

Width (m)	Weight (kg)	Article no.	Price (€)
0,74	6,70	007909	137,80



## LATTICE BEAM BASE PLATE



- Steel, hot dip galvanized
- Movable
- Use in connection with a decking transom, for further extensions of scaffold pattern when bridging with lattice beams



Weight (kg)	Article no.	Price (€)
6,00	000235	93,60

**STACKING PALLET**



- Steel tube, hot-dip galvanized
- Specially suited for module scaffolds, e.g. tubes and toe boards
- Open all round
- Suited for stacked and crane transports
- The tube supports are removable and are to be stowed securely in the base frame so that empty pallets can be transported and stacked
- Special designs on request
- Push-on tube with bevel on one side, also available separately (Article no. 005791)



Length (m)	Width (m)	Weight (kg)	PU (pcs.)	Article no.	Price (€)
0,85	0,85	30,50	5	006962	232,20
1,25	0,55	31,80	5	010334	231,90
1,25	0,85	35,00	5	005614	240,20

**SCAFFOLD PALLET FOR ASSEMBLY FRAME**



- Steel tube, hot dip galvanized
- Continuous fork mount for safe fork-lift transport
- Additional cut-outs allow side retracting
- Capacity: 20 Assembly frames

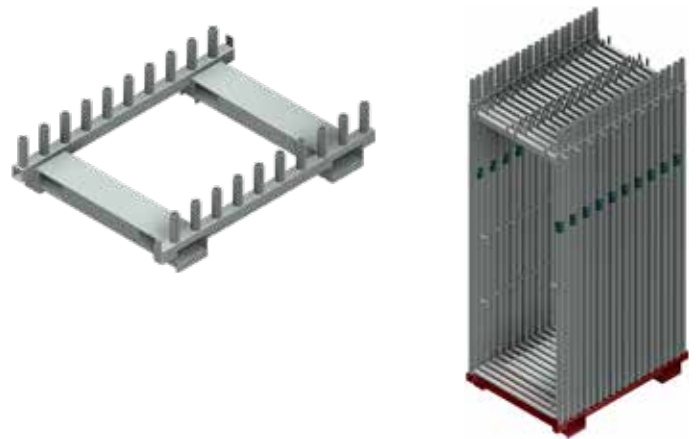

System	Length (m)	Width (m)	Weight (kg)	PU (pcs.)	Article no.	Price (€)
UNI 70	1,11	0,79	31,10	5	008317	301,90
UNI 100	1,11	1,16	38,70	5	008367	328,10

**OTHER PRODUCTS FOR STORAGE AND TRANSPORT FIND IN OUR PRICE LIST 'ACCESSORIES'**



## ASSEMBLY SECURITY GUARD RAIL

The assembly security guard rail (MSG) serves as a security measure on the top scaffold and in the ascent field. The system consisting of guard rail posts and extendable guard rail spar is mounted in the construction of the scaffold before entering the top scaffold position of the underlying layer.

- Approved by the German Institute for Building Supervision DIBt under the number: Z-8.22-1002.



## POST FOR ASSEMBLY SECURITY GUARD RAIL



- Coaxially arranged aluminum tubes with two swivel pin connections
- Fits any scaffold tube  $\varnothing$  48.3 mm
- Maximum flexibility in the application
- Tool-free fixation through anti-rotation device
- Operation (locking and unlocking) from above and below
- At the same time assembly and disassembly of guard rail and intermediate beam

Weight (kg)	PU (pcs.)	Article no.	Price (€)
5,80	45	011088	251,50



**GUARD RAIL FOR ASSEMBLY SECURITY GUARD RAIL** 

- Aluminum tube
- Two-sided recesses for attachment to the guard rail post
- Locking pin prevents the unintentional sliding apart of the tubes during transport
- Piston guide belts for smooth sliding of the aluminum tubes



For field length	Weight (kg)	PU (pcs.)	Article no.	Price (€)
1,50 - 1,57 m	3,40	10	011437	133,40
2,00 - 3,07 m	4,60	10	011156	143,90



**FRONT ASSEMBLY SECURITY GUARD RAIL** 

- Ergonomic, easy to handle and economical to install
- One-piece component as system-free design, no moving parts
- Tool-free installation
- Integrated deadlock
- For easy installation, users stand on the covered position
- Comfortable implementation from below and above

Weight (kg)	PU (pcs.)	Article no.	Price (€)
7,10	10	011131	282,80



## ASSEMBLY SECURING CONSOLE

The assembly securing consoles (MSK) are a logistically friendly and cost-effective alternative to the assembly security guard rail (MSG). Thanks to the non-rotating and swivel-free assembly option installation with already pre-assembled Standard swivel pin guard rails from the secure scaffold level is easily possible.

The system was developed in cooperation with BG BAU.



## ASSEMBLY SECURING CONSOLE



- Aluminum
- Integrated guard rail post with two swivel pin connections
- Securing bracket against lifting
- Tool-free assembly
- Easy implementation from above and below
- Including protective caps

Model	Length (m)	Weight (kg)	Article no.	Price (€)
UNI	1,41	3,60	011294	158,50



SET - PERSONAL PROTECTIVE EQUIPMENT MILLER 1

EN N



- Revolution R2 Comfort harness – with 80 cm back eyelet extension (EN 361), elastic dura flex belt band, sharp edge tested, front and rear eyelet, comfort back pads, automatic fasteners for quick on and off, belt end clips, swivel connection at waist height for optimal ergonomics when bending or stretching, attachment point for tools and accessories, integrated label tray
- Lifetime of the material is 10 years
- Lanyards with shock absorber - length 2.00 m, sharp edges tested, horizontally approved (attachment point on foot level), 63 mm scaffold hook, stretchy design for more latitude of movement, safety clip for fastening to harness, Teflon-coated for longer life, EN 354 and EN 355
- Equipment bag - 0.27 x 0.80 m (D x H), made of PVC, red



Size	Article no.	Price (€)
S - M	006273	280,00
L - XL	005610	280,00

SET - PERSONAL PROTECTIVE EQUIPMENT MILLER 2

EN N



- Revolution R2 Comfort harness – with 80 cm back eyelet extension (EN 361), elastic dura flex belt band, sharp edge tested, front and rear eyelet, comfort back pads, automatic fasteners for quick on and off, belt end clips, swivel connection at waist height for optimal ergonomics when bending or stretching, attachment point for tools and accessories, integrated label tray
- Twin Manyard EDGE 2.00 m - with 2 x 63 mm aluminum hooks (EN 354 + 355), sharp edges tested, integrated shock absorber with fall of indicator
- Lifetime of the material is 10 years
- Equipment bag - 0.27 x 0.80 m (D x H), made of PVC, red



Size	Article no.	Price (€)
L - XL	011284	410,00

ALL SET COMPONENTS MAY ALSO BE ORDERED SEPARATELY

OTHER PROTECTIVE EQUIPMENT FIND IN OUR PRICELIST 'ACCESSORIES'



## KASK INDUSTRIAL CLIMBING HELMET SUPERPLASMA A0

EN ID N

- Tested and approved according to EN 397
- With chin strap
- Adjusting wheels allow one quick and easy adjustment to the right size
- With ring for attaching the helmet to a belt

Color	Article no.	Price (€)
dark blue	010496	74,60
white	010497	74,60
yellow	010498	74,60
orange	010499	74,60
red	010500	74,60
green	010501	74,60
dark green	010502	74,60
light blue	010503	74,60
black	010453	74,60



## KASK INDUSTRIAL CLIMBING HELMET ZENITH

EN ID N

- Tested and approved according to EN 397 and EN 50365
- Various settings allow a quick and easy adjust
- With ring for attaching the helmet to a belt

Color	Article no.	Price (€)
blue	010504	84,70
white	010505	84,70
yellow	010506	84,70
orange	010507	84,70
red	010508	84,70
green	010509	84,70
black	010510	84,70



**OTHER PROTECTIVE EQUIPMENT FIND IN OUR PRICELIST 'ACCESSORIES'**

SCAFFOLD BAY LENGTH 2.50 M				Length x Height (m)		
				100.00 x 10.20	50.00 x 10.20	10.00 x 10.20
				1,020 m <sup>2</sup> - 40 Fields	510 m <sup>2</sup> - 20 Fields	102 m <sup>2</sup> - 4 Fields
Product description	Dimension (m)	Article no.	Price (€)	Pieces	Pieces	Pieces

BASE EQUIPMENT						
Vertical frame steel 70	2,00 x 0,74	000004	100,40	164	84	20
Timber deck 0.32 m	2,50 x 0,32	000032	75,50	314	154	26
Access deck with plywood deck	2,50 x 0,63	000388	387,20	4	4	4
Diagonale	2,50	000080	36,80	32	16	4
Starting transnom	0,74	000219	51,90	2	2	2
Guard rail	2,50	011943	21,00	327	163	32
Toe board	2,50	000069	22,80	160	80	16
End toe board	0,74	000073	18,80	8	8	8
Double end guard rail	0,74	000061	40,00	6	6	6
Guard rail with deck fastening	1,00 x 0,74	000077	45,90	39	19	3
Top end guard rail	1,00 x 0,74	000064	78,60	2	2	2
Lower diagonal fastener		000089	8,10	14	6	0
Base jack	0,60	000320	22,00	82	42	10
Wall tie	0,60	000241	16,40	43	23	7
Standard coupler	SW 19	000326	8,60	43	23	7
Expansion plug	0,07	000357	0,40	43	23	7
Eye-bolt Ø 12 mm	0,12	000359	1,70	43	23	7
Total price (€)				58.938,20	30.564,60	7.902,60

EXTRA CHARGE IN EXCHANGE				1,020 m <sup>2</sup> - 40 Fields		510 m <sup>2</sup> - 20 Fields		102 m <sup>2</sup> - 4 Fields	
FROM	AGAINST	Article no.	Price (€)	Number (pcs.)	Extra charge (€)	Number (pcs.)	Extra charge (€)	Number (pcs.)	Extra charge (€)
Access deck with plywood deck	Access deck with aluminum deck	000389	426,60	4	157,60	4	157,60	4	157,60
Timber deck 0.32 m	Steel deck OPTI-LINE 0.32 m	008845	97,80	314	7.002,20	154	3.434,20	26	579,80
Timber deck 0.32 m	Aluminum deck with steel caps	007017	305,20	157	24.209,40	77	11.873,40	13	2.004,60
Vertical frame steel	Assembly frame aluminum	000252	147,70	164	7.757,20	84	3.973,20	20	946,00
Access decks	Platform stair tower*	-	-	1	2.668,90	1	2.668,90	1	2.668,90

\*The scaffold components required for the platform stair tower are summarized in a price and offset against the access decks.

SCAFFOLD BAY LENGTH 3.00 M				Length x Height (m)		
				99.00 x 10.20	51.00 x 10.20	12.00 x 10.20
				1,010 m <sup>2</sup> - 33 Fields	520 m <sup>2</sup> - 17 Fields	122 m <sup>2</sup> - 4 Fields
Product description	Dimension (m)	Article no.	Price (€)	Pieces	Pieces	Pieces

BASE EQUIPMENT						
Vertical frame steel 70	2,00 x 0,74	000004	100,40	138	72	20
Timber deck 0.32 m	3,00 x 0,32	000030	85,30	258	130	26
Access deck with plywood deck	3,0 x 0,63	000387	439,70	4	4	4
Diagonale	3,00	000079	40,70	28	16	4
Starting transom	0,74	000219	51,90	2	2	2
Guard rail	3,00	011944	23,00	270	139	32
Toe board	3,00	000066	24,20	132	68	16
End toe board	0,74	000073	18,80	8	8	8
Double end guard rail	0,74	000061	40,00	6	6	6
Guard rail post with deck fastening	1,00 x 0,74	000077	45,90	32	16	3
Top end guard frame	1,00 x 0,74	000064	78,60	2	2	2
Lower diagonal fastener		000089	8,10	12	6	0
Base jack	0,60	000320	22,00	68	36	10
Wall tie	0,60	000241	16,40	36	20	7
Standard coupler	SW 19	000326	8,60	36	20	7
Expansion plug	0,07	000357	0,40	36	20	7
Eye-bolt Ø 12 mm	0,12	000359	1,70	36	20	7
Total price (€)				52.854,40	28.338,80	8.469,40

EXTRA CHARGE IN EXCHANGE				1,010 m <sup>2</sup> - 33 Fields		520 m <sup>2</sup> - 17 Fields		122 m <sup>2</sup> - 4 Fields	
FROM	AGAINST	Article no.	Price (€)	Number (pcs.)	Extra charge (€)	Number (pcs.)	Extra charge (€)	Number (pcs.)	Extra charge (€)
Access deck with plywood deck	Access deck with aluminum deck	000390	469,30	4	328,40	4	328,40	4	328,40
Timber deck 0.32 m	Steel deck OPTI-LINE 0.32 m	008846	111,60	258	6.785,40	130	3.419,00	26	683,80
Timber deck 0.32 m	Aluminum deck with steel caps	007018	351,10	129	23.284,50	65	11.732,50	13	2.346,50
Vertical frame steel	Assembly frame aluminum	000252	147,70	138	6.527,40	72	3.405,60	20	946,00
Access decks	Platform stair tower*	-	-	1	2.675,60	1	2.675,60	1	2.675,60

\*The scaffold components required for the platform stair tower are summarized in a price and offset against the access decks.

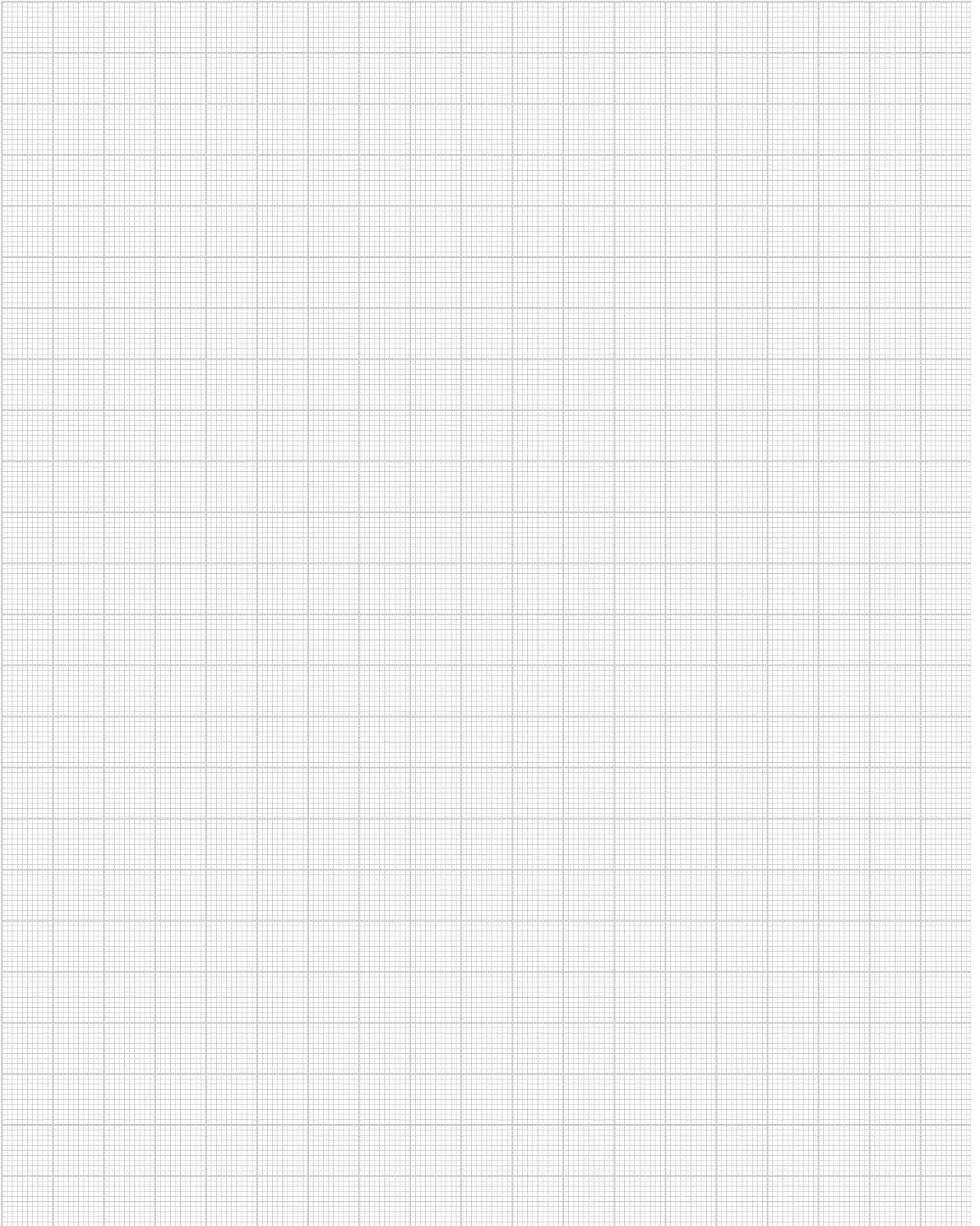

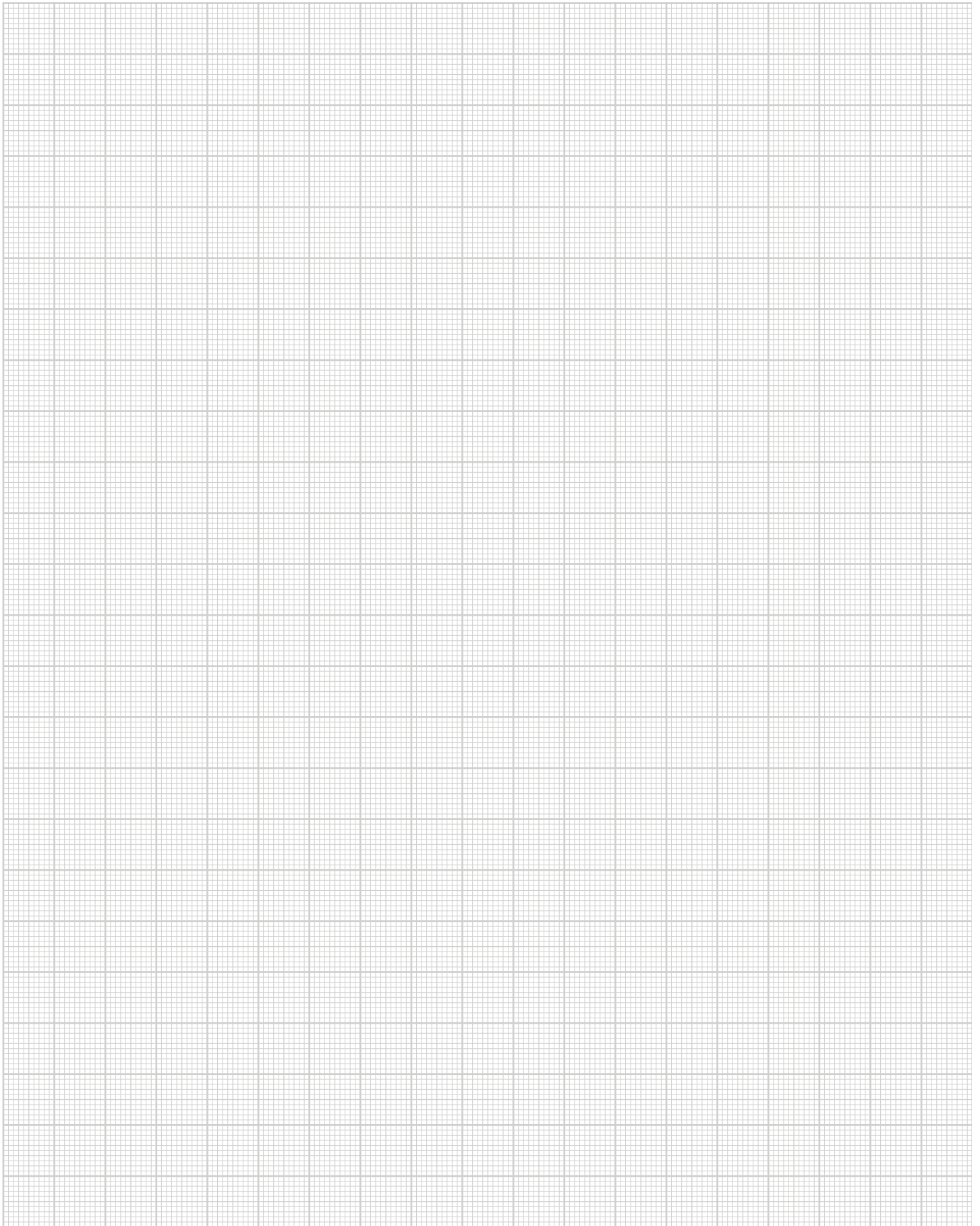

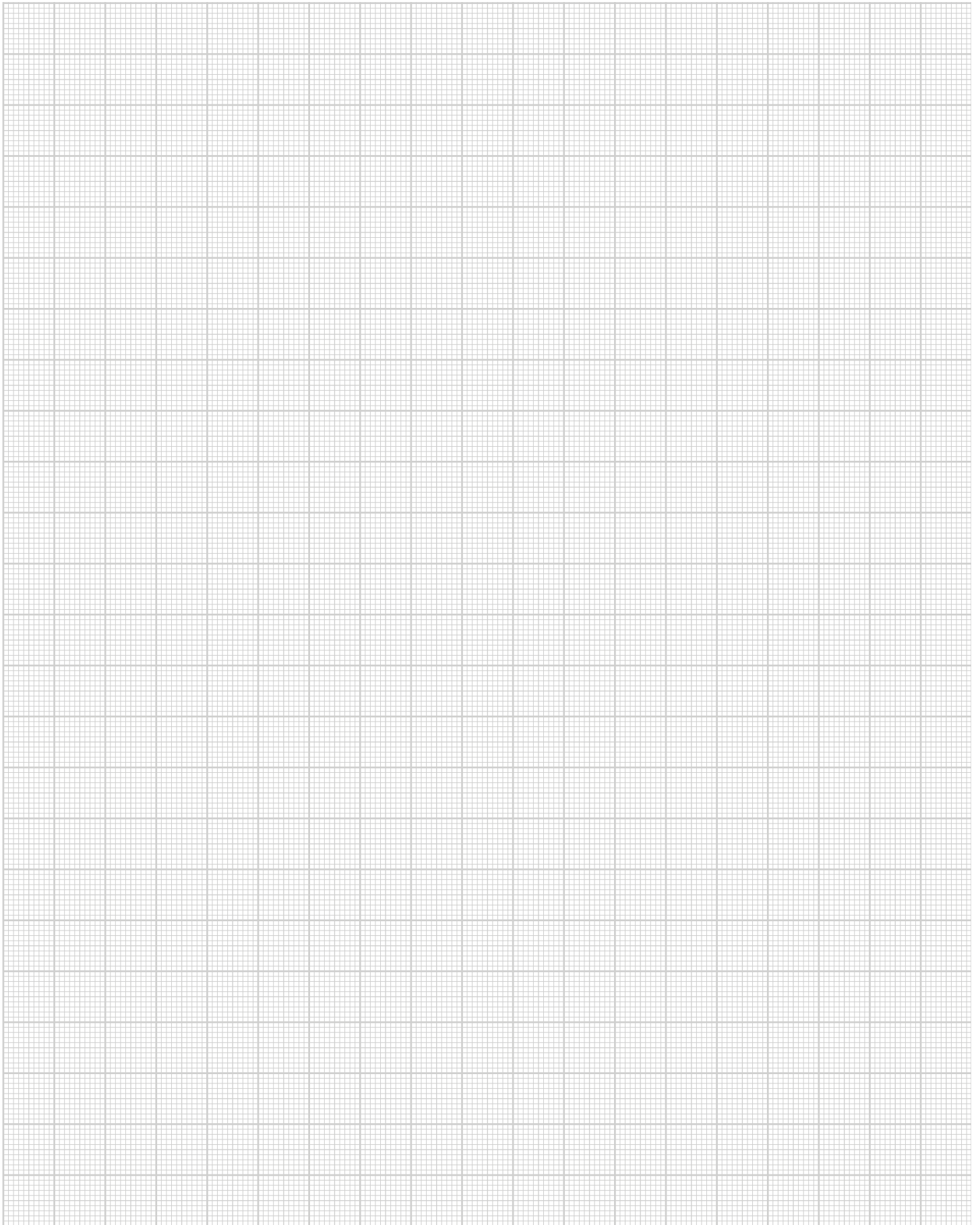



**SIMPLY FILL OUT THE FORM AND SEND TO**  
 Fax: +49 2391 8105 375 or E-mail: info@mj-geruest.de

Company \_\_\_\_\_

Customer no. \_\_\_\_\_

Street \_\_\_\_\_

Phone \_\_\_\_\_

Postal code, city, country \_\_\_\_\_

Fax \_\_\_\_\_

Name of buyer \_\_\_\_\_

E-mail \_\_\_\_\_

ORDER  INQUIRY

Order/Quotation please send  by post  by fax  by e-mail

PRODUCT DESCRIPTION	ARTICLE NO.	QUANTITY	UNIT PRICE €	TOTAL VALUE €

**ORDER VALUE €** \_\_\_\_\_

All prices exclude VAT applicable at the time of shipment. All dimensions and weights are non-binding approximate values. Technical data is subject to change without prior notice. Prices are charged as applicable on the day of shipment. Sale is subject exclusively to our sales terms and delivery conditions. In brief: place of business and jurisdiction is Plettenberg. Extended reservation of property rights until full payment of all our outstanding accounts are recieved. Our prices are ex work.

Date of delivery \_\_\_\_\_

Shipping method \_\_\_\_\_

Delivery address: \_\_\_\_\_

Freight costs \_\_\_\_\_

\_\_\_\_\_

Terms of delivery \_\_\_\_\_

\_\_\_\_\_

Terms of payment \_\_\_\_\_

Stamp/Signature \_\_\_\_\_

\_\_\_\_\_

MJ-Consultant \_\_\_\_\_

Date \_\_\_\_\_



[WWW.MJ-SCAFFOLDING.COM](http://WWW.MJ-SCAFFOLDING.COM)



### OPTIMA

Flexible façade scaffolding



### OPTIMA METRIC

Flexible façade scaffolding



### OPTIMA TOP

Flexible façade scaffolding



### UNI-CONNECT

Frame System 73/109

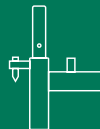

### UNI

Frame System 70/100



### UNI TOP

Frame System 65/100



### COMBI

Modular System



### WALL AND ROOF

Enclosure



### ACCESSORIES

Universal