

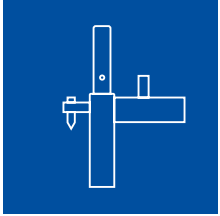

**MJ-GERÜST**  
Scaffolding Systems

[WWW.MJ-SCAFFOLDING.COM](http://WWW.MJ-SCAFFOLDING.COM)     



# UNI TOP

**PRICES** | EDITION 04.2025

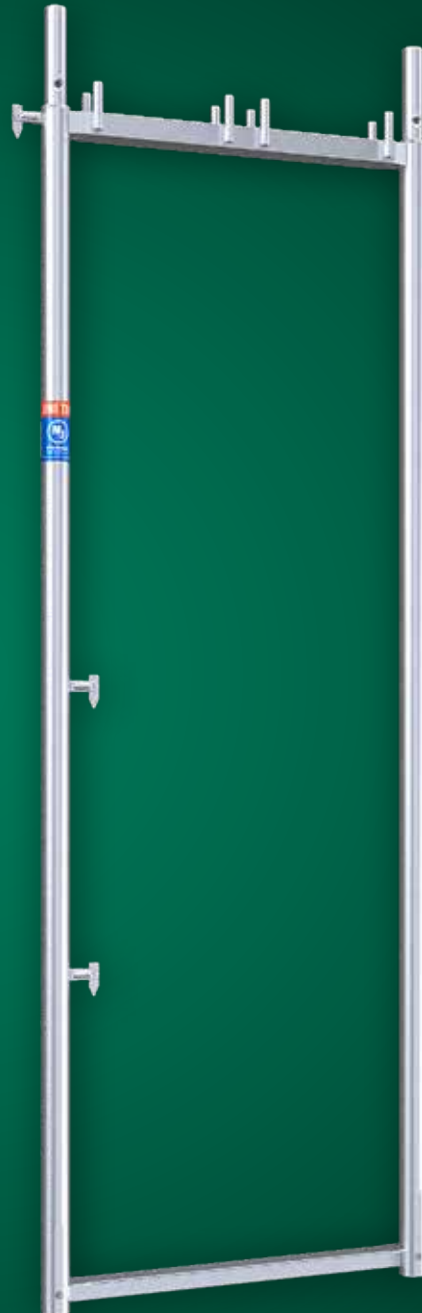

---

**SCAFFOLDING MADE IN  
PLETTENBERG**

## SCAFFOLDINGS MADE IN PLETTENBERG

MJ-Gerüst GmbH, based in Plettenberg in the German region of Sauerland, is part of a strong group of companies, which can look back on more than 50 years of company history. The core competence of the family company lies in the production and worldwide distribution of high-quality steel and aluminum scaffolding systems, which offer almost limitless possibilities in the field of modern system scaffolding construction.

With a unique range of products and a wide range of universal accessories, we offer our customers the option of completing existing scaffolding material in a system-compatible complement. A highly valued advantage by our customers that has given our scaffolding international recognition and prominence.

Development, production and sales. These are the cornerstones of our range of services, which are supplemented by numerous additional services. Especially our support in the planning and implementation of difficult projects is claimed. A service in which our technical know-how and experience can often contribute to considerable time and cost savings.

Only through qualified work can a safe quality product be created. Our proven quality management reflects our knowledge and experience and makes the quality of our products measurable. In order to guarantee our high quality standards, our production processes are constantly accompanied by external examination offices and engineers.



## OUR COMPANY - YOUR BENEFITS

- Production in Germany at the location Plettenberg
- System compatible, high quality and norm compliant scaffold systems
- Certifications according to DIN EN 9001, 14001 and 50001
- Highest product quality through dynamic quality management
- Short-term availability of material due to high storage capacities and short decision-making processes
- Use of the modern production technology and permanent optimization of technological production running
- Project support already in the planning phase

## PARTNER AND CERTIFICATES



BUNDESINNING  
GERÜSTBAU

MPA NRW



SGUV  
SESE  
SISP  
Schweizerischer Gerüstbau-Unternehmer-Verband  
Société des Entrepreneurs Suisse en Echafaudages  
Società degli Imprenditori Svizzera dei Ponteggi

Deutsches  
Institut  
für  
Bautechnik





[WWW.MJ-SCAFFOLDING.COM](http://WWW.MJ-SCAFFOLDING.COM)



The system	04
Base jacks	06
Starting transom	07
Frames	08
Decks	13
Climb up	16
Reinforcement	17
Guard rails	18
Tore boards	20
Upper close-off and roofguard	21
Anchoring	23
Brackets	26
Climb up, Stairs	31
Gap cover	33
Stairs	34
Transom	35
Deck fastenings	37
Gap cover	39
Head and base attachments	42
Couplers, Scaffold tubes	43
Lattice beams	45
Storage and transport	47
Securing during assembly of the scaffold	48
Scaffold examples	53
Order form	55

 Made in Plettenberg

 Net price, not discountable

 European standard

 Grant BG BAU

 Individual identification

 Delivery time on request

All prices exclude VAT applicable at the time of shipment. All dimensions and weights are non-binding approximate values. Technical data is subject to change without prior notice. Prices are charged as applicable on the day of shipment. Sale is subject exclusively to our sales terms and delivery conditions. An excerpt: place of business and jurisdiction is Plettenberg. Extended retention of title until full payment of all outstanding claims. Our prices are ex works.

## UNI TOP: EASY - FAST - SAFE

The facade scaffolding system UNI TOP meets the requirements of the national technical approval of the Deutsches Institut für Bautechnik Berlin (German Centre of Competence for Construction) Z-8.1-902.

By connecting the individual scaffold bays with decks which are placed on the bolts in the vertical frames, the system can be assembled in virtually no time. This also rules out the risk of the decks slipping. This offers users a high degree of safety. The swivel pins in the vertical frames are used to fasten guard rails and diagonal braces without the use of tools.

The scaffolding system UNI TOP can be used according to DIN 4420-1:1990 for scaffolding groups 1-3 (which correspond to load classes 1-3 under DIN EN 12811-1) with bay widths  $l \leq 3.0$  m, and as guard and roof guard scaffolds. In addition, the use of a roof guard is numbered for in this design in compliance with the standard.

Due to its extensive and functionally aligned accessories, the system is able to achieve a degree of flexibility that also enables scaffolding for challenging objects.



### EFFICIENT

due to optimized ease of assembly



### PROFITABLE

through long life and excellent value retention



### FLEXIBLE

through countless field lengths/widths



### STRONG

up to 6 kN/m<sup>2</sup> full surface  
up to 10 kN/m<sup>2</sup> partial surface load



## THE ESSENTIAL BENEFITS OF THE SYSTEM IN OVERVIEW

- Gen. approved by building inspection, also for common, manufacturer independent use. For details on type and scope, please refer to the approval models: Z-8.22-902
- Horizontal bracing through peg/deck locking mechanism
- Short assembly times without the use of any additional tools
- High safety features: decks are firmly locked to the vertical frames, inherent and vertical moving loads are discharged directly by the decks lying on the vertical frames
- No 'tripping hazards' on the deck level caused by protruding parts: the vertical frames are equipped with special 'T-profiles'
- Independent perpendicular adjustment through fixed knot connections: after the initial alignment, the alignment of all further scaffold levels takes place automatically
- Maximum work surface due to outside diagonal braces
- Decks made of timber, steel and aluminum



Set up the base jacks, attach base transom, mount guard rails (only in the diagonal bay).



Mount vertical frames.



Mount diagonal brace via swivel pins.



Mount decks, align scaffold bay perpendicularly to guard rail and frame using spirit level.



Mount inside access deck.



Assemble vertical frames and decks of the next level, then mount diagonals, guard rails and toe boards.

Visit us on



WWW.GERUESTLAGER.DE

**UNDERLAY WOODS**

- As a load-distributing support
- Sawn
- Dimension +/- 10 mm



Length (m)	Width (m)	Height (m)	Weight (kg)	PU (pcs.)	Article no.	Price (€)
1,00	0,24	0,04	1,50	80	009203	10,20
1,50	0,24	0,04	2,25	80	010360	12,30

**PROTECTIVE PAD FOR BASE JACK**

- Plastic
- With reflector

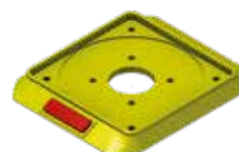

PU (pcs.)	Article no.	Price (€)
80	008110	4,40

**RUBBER PAD FOR BASE JACK**

- Made from recycled cable material
- Oil and acid resistant
- Stackable (015339)



Height (m)	Width (m)	Weight (kg)	PU (pcs.)	Article no.	Price (€)
0,03	0,24	1,60	80	015338	15,10
0,03	0,24	1,50	80	015339	15,10

**BASE JACK**

EN

- Steel, hot dip galvanized
- With tube spindle
- Base plate 150 x 150 mm
- For adjusting level with differences in height of the underground
- Knurled nut with collar for centring the shaft on the spindle
- Lock to prevent unscrewing of the knurled nut and to ensure the necessary bridging length
- Can be used as a head spindle



Length (m)	Weight (kg)	PU (pcs.)	Article no.	Price (€)
0,30	2,40	375	000318	17,80
0,50	3,10	300	000319	21,30
0,60	3,40	300	000320	22,00
0,78	3,90	250	000321	29,80
1,00	4,70	200	000322	35,70

## SWIVEL BASE JACK

EN

- Steel, hot dip galvanized
- With tube spindle
- Swiveling base plate 150 x 150 mm
- For adjusting level with differences in height of the underground
- Knurled nut with collar for centring the shaft on the spindle
- Lock to prevent unscrewing of the knurled nut and to ensure the necessary bridging length
- Can be used as a head spindle
- Additional longitudinal scaffold bracing required at in the base
- Permissible load: 25.4 kN



Length (m)	Weight (kg)	PU (pcs.)	Article no.	Price (€)
0,50	3,10	250	000323	46,30
0,80	4,30	200	013292	54,50

## DECK TRANSOM



- Steel, hot dip galvanized

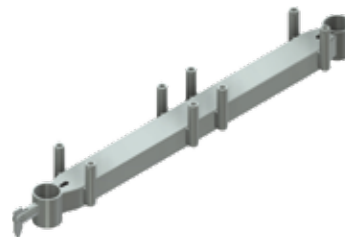

Model	Width (m)	Weight (kg)	Article no.	Price (€)
2-board	0,65	3,00	001082	41,10
3-board	1,00	4,50	001083	55,00

**YOU WILL FIND MORE PARTS ON PAGE 42  
AND OUR PRICE LIST "ACCESSORIES".**

## VERTICAL FRAME STEEL 65



- Steel tube  $\varnothing$  48.3 mm, hot dip galvanized
- With bolts for attaching two decks
- To secure the joints by means of security pins, the posts are perforated in the upper and lower areas

Height (m)	Width (m)	Weight (kg)	PU (pcs.)	Article no.	Price (€)
0,50	0,65	8,50	50	001021	77,50
1,00	0,65	11,00	50	001020	84,00
1,50	0,65	14,20	25	001022	89,00
2,00	0,65	17,20	25	001019	92,90



## VERTICAL FRAME STEEL 100



- Steel tube  $\varnothing$  48.3 mm, hot dip galvanized
- With six bolts for attaching three decks
- To secure the joints by means of security pins, the posts are perforated in the upper and lower areas
- The assembly frame meets the requirements of width class A/F 09 and is designed for highly loaded scaffolds up to load class 6

Height (m)	Width (m)	Weight (kg)	PU (pcs.)	Article no.	Price (€)
0,50	1,00	12,50	50	001030	92,10
1,00	1,00	15,00	50	001027	96,60
2,00	1,00	22,50	25	001026	125,40



## VERTICAL FRAME ALUMINUM



- Aluminum tube  $\varnothing$  48.3 mm
- With bolts for attaching two decks
- To secure the joints by means of security pins, the posts are perforated in the upper and lower areas

Height (m)	Width (m)	Weight (kg)	PU (pcs.)	Article no.	Price (€)
0,50	0,65	4,50	25	007106	111,80
1,00	0,65	6,00	25	002759	123,00
2,00	0,65	9,00	25	001035	139,00



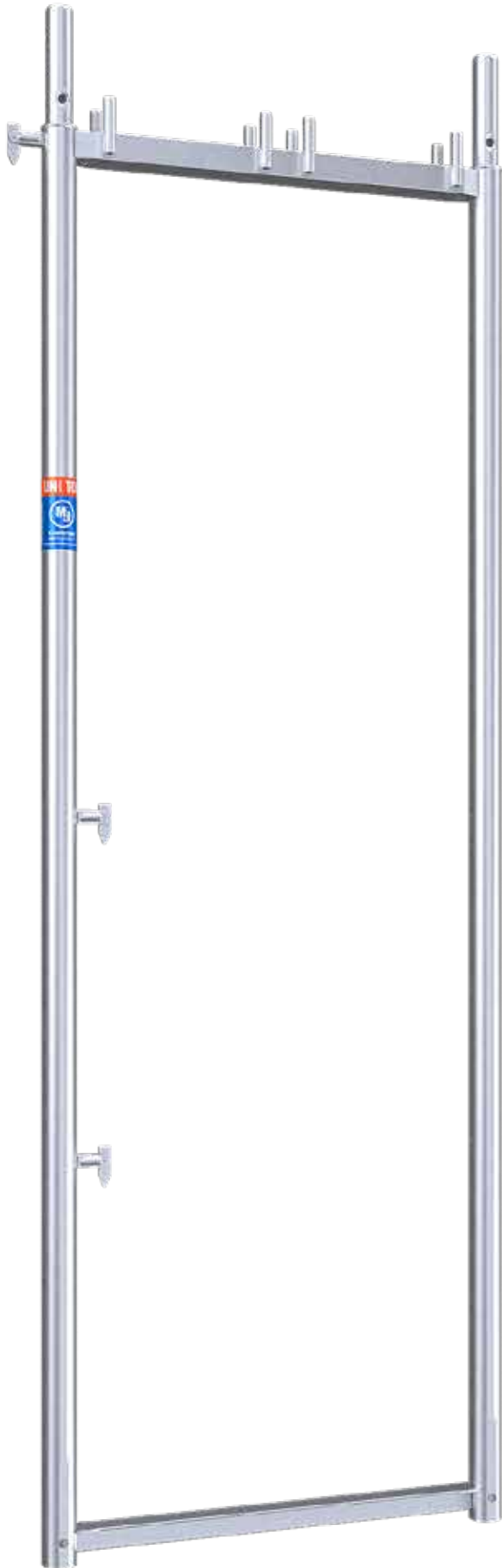

### TUBE CONNECTOR

Molded tube connector with slim collar for high load-bearing capacity and at the same time optimized stackability.



### RAIL HOUSINGS

Guard rail support with new, improved wedge geometry for secure positive and non-positive reception of up to two back guard rails.



### T-PROFILE

- Without a stumbling block
- Protected from dirt

## VERTICAL FRAME STEEL 1-BOARD



- Steel tube  $\varnothing$  48.3 mm, hot dip galvanized
- With bolts for attaching one deck
- To secure the joints by means of security pins, the posts are perforated in the upper and lower areas



Height (m)	Width (m)	Weight (kg)	PU (pcs.)	Article no.	Price (€)
2,00	0,40	16,30	25	001173	102,40

## VERTICAL FRAME STEEL FOR ROOF OVERHANGS



- Steel tube  $\varnothing$  48.3 mm, hot dip galvanized
- For converting roof overhangs and building protrusions



Height (m)	Width (m)	Weight (kg)	PU (pcs.)	Article no.	Price (€)
2,00	0,65	20,50	25	001024	140,00
2,00	1,00	24,00	25	001025	181,60

## ROOFGUARD FRAME



- Steel tube  $\varnothing$  48.3 mm, hot dip galvanized



Höhe (m)	Breite (m)	Gewicht (kg)	VPE (Stk.)	Art.-Nr.	Preis (€)
2,00	0,65	22,74	25	011235	162,00

## STAIRCASE POST



- Steel tube Ø 48.3 mm, hot dip galvanized
- For a connection between platform stair tower and scaffold

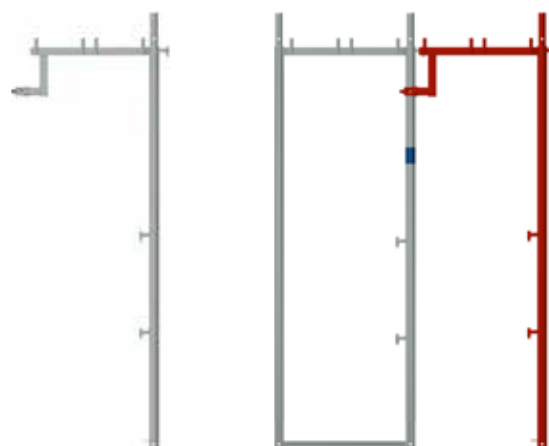

Height (m)	Width (m)	Weight (kg)	PU (pcs.)	Article no.	Price (€)
2,00	0,65	11,60	50	010920	106,80

## CONVERSION FRAME



- Steel tube Ø 48.3 mm, hot dip galvanized
- For converting a 3-board frame into a 2-board frame



Height (m)	Width (m)	Weight (kg)	PU (pcs.)	Article no.	Price (€)
1,00	1,00/0,65	14,10	25	012000	138,70
2,00	1,00/0,65	21,40	25	007889	148,00

## WALK-TROUGH FRAME TRUSS BEAM



- Steel tube Ø 48.3 mm, hot dip galvanized
- With tube connector
- Construction is carried out as standard on two walk-through frame standard
- Wide passage for passerby and pedestrians protection in the lowest scaffold lay



Model	Width (m)	Weight (kg)	Article no.	Price (€)
4-board	1,35	15,90	001090	159,00
5-board	1,65	18,90	001091	186,00

## WALK-TROUGH FRAME STANDARD



- Steel tube Ø 48.3 mm, hot dip galvanized
- Suitable for walk-through class-trough frame truss beam



Height (m)	Weight (kg)	PU (pcs.)	Article no.	Price (€)
2,00	7,50	50	000046	49,70

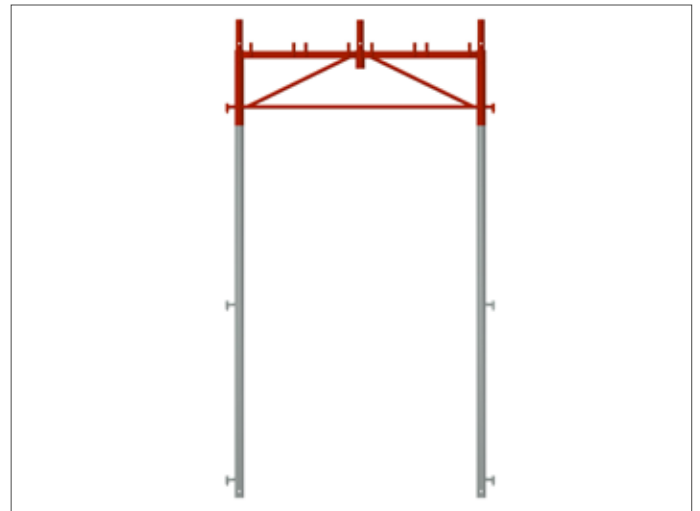
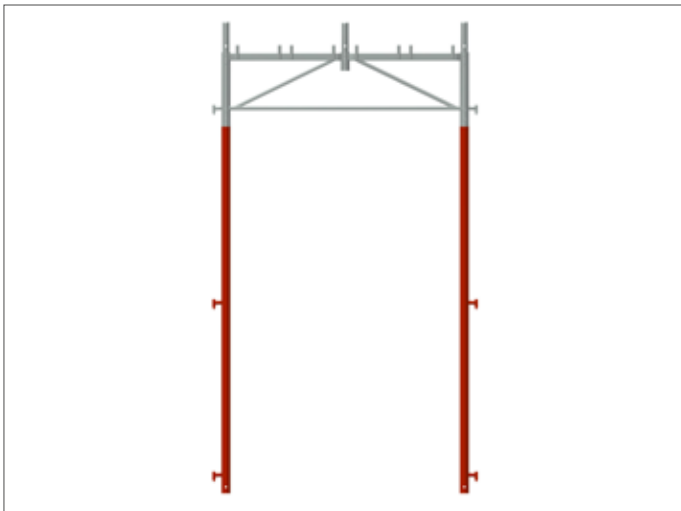

## TIMBER DECK 0.29 M



- Timber, 48 mm thick
- With galvanized deck caps
- Can be used on both sides
- Mechanically checked in accordance with DIN EN 14801 and DIN 4074 MS 10/13
- Waterproofed and weatherproof glued
- Can be used in guard and roof guard scaffolds as per DIN 4420 up to  $L \leq 3.00$  m



Length (m)	Width (m)	Weight (kg)	Load class	PU (pcs.)	Article no.	Price (€)
0,65	0,29	5,00	6	80	001076	44,40
1,00	0,29	7,50	6	80	001075	52,80
1,50	0,29	10,50	6	80	001074	61,20
2,00	0,29	14,00	5	80	001073	70,20
2,50	0,29	17,00	4	80	001072	78,90
3,00	0,29	21,50	3	80	001071	89,50

## STEEL DECK 0.29 M



- Steel, hot dip galvanized
- Non-slip surface through pronounced hole profiling
- Optimum stackability due to the selected cross-section shape
- Spot welded



**STRONGER DUE  
TO NEW SURFACE**

Length (m)	Width (m)	Weight (kg)	Load class	PU (pcs.)	Article no.	Price (€)
0,65	0,29	5,00	6	80	008820	60,60
1,00	0,29	6,50	6	80	008821	64,80
1,50	0,29	9,50	6	80	008822	73,80
2,00	0,29	12,80	6	80	008823	83,80
2,50	0,29	15,70	5	80	008824	95,50
3,00	0,29	18,70	4	80	008825	107,90

**STEEL DECK 0.15 M**



- Steel, hot dip galvanized
  - Extremely robust, for the toughest operations
  - Bracket deck for scaffold widening with 1/2 deck width, e.g. for WDVS work
  - Compensating deck to close gaps in platform scaffolding
  - Good stackability
  - Also fits in the main scaffold instead of the standard decks
- WDVS** = Thermal insulation composite system



Length (m)	Width (m)	Weight (kg)	Load class	PU (pcs.)	Article no.	Price (€)
0,65	0,15	3,26	3	102	013270	70,00
1,00	0,15	4,60	3	102	013272	73,50
1,25	0,15	5,80	3	102	013274	78,70
1,50	0,15	6,39	3	102	013275	79,90
2,00	0,15	8,23	3	102	013276	91,90
2,50	0,15	10,49	3	102	013277	114,90
3,00	0,15	12,33	3	102	013278	121,40

**ALUMINUM DECK WITH STEEL CAPS**



- Non-slip surface and easy to stack
- Optimized ratio of weight and carrying through computerassisted profile optimization
- Steel caps, therefore robust and durable
- Patented beam reinforcements in the walking area ensure minimal deflection and best possible slip resistance

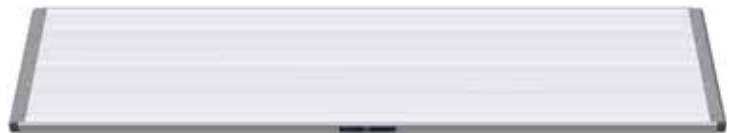

Length (m)	Width (m)	Weight (kg)	Load class	PU (pcs.)	Article no.	Price (€)
0,65	0,59	6,50	6	18	008190	135,30
1,00	0,59	8,70	6	18	008191	151,90
1,50	0,59	11,90	6	18	008192	187,30
2,00	0,59	15,10	6	18	008193	207,40
2,50	0,59	18,30	5	18	008194	230,00
3,00	0,59	21,50	4	18	008195	270,00

## ALUMINUM DECK WITH ALUMINUM HEAD PIECE



- Extremely robust model
- Can be used on both sides
- With high load capacity and non-slip surface
- Minimal deflection

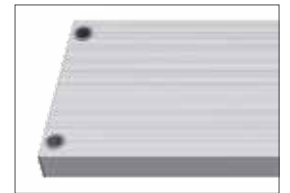

Length (m)	Width (m)	Weight (kg)	Load class	PU (pcs.)	Article no.	Price (€)	
1,00	0,29	4,00	6	80	001116	76,80	⌚
1,50	0,29	5,80	6	80	001117	97,80	⌚
2,00	0,29	7,60	6	80	001118	118,20	⌚
2,50	0,29	9,50	5	80	001119	141,50	
3,00	0,29	11,50	4	80	001120	158,60	
4,00	0,29	15,00	3	80	001121	220,00	

## DECK CONNECTOR



- Steel, hot dip galvanized
- For connecting of two aluminum decks
- Only required for 4.00 m aluminum decks



Weight (kg)	Article no.	Price (€)
0,10	000311	13,20

**YOU CAN FIND MORE DECKS FOR SPECIAL SOLUTIONS ON PAGE 38.**

## ALUMINUM ACCESS DECK



- With non-slip aluminum deck
- Weather resistant and robust
- With integrated aluminum ladder (Length 2.00 m extendable)
- Access flap made of corrugated sheet metal, open to the side



Length (m)	Width (m)	Weight (kg)	Load class	PU (pcs.)	Article no.	Price (€)
2,00	0,60	22,80	4	14	009456	360,00
2,50	0,60	23,00	4	14	003706	380,00
3,00	0,60	26,00	3	14	003707	420,00



## ACCESS LADDER



- As a separate ladder for the inside scaffold ascent
- With riveted claws for safe mounting to the access decks

Model	Length (m)	Width (m)	Weight (kg)	Article no.	Price (€)	Preis (€)
Aluminium	2,16	0,40	3,00	–	001323	80,70
Steel	2,16	0,40	10,50	80	000172	79,90



## DIAGONAL BRACE



- Steel tube  $\varnothing$  48.3 mm, hot dip galvanized
- The assembly takes place on the outside of the scaffold using the upper swivel pin on the vertical frame
- Perpendicular scaffolding construction is guaranteed because the diagonal causes automatic alignment, thus a floor-wise alignment is not required

Field (m)	Length (m)	Weight (kg)	PU (pcs.)	Article no.	Price (€)
1,50	2,50	7,50	50	000082	31,50
2,00	2,83	8,00	50	000081	34,10
2,50	3,20	9,50	50	000080	36,80
3,00	3,61	11,00	50	000079	40,70
4,00	4,53	13,80	50	000231	52,40

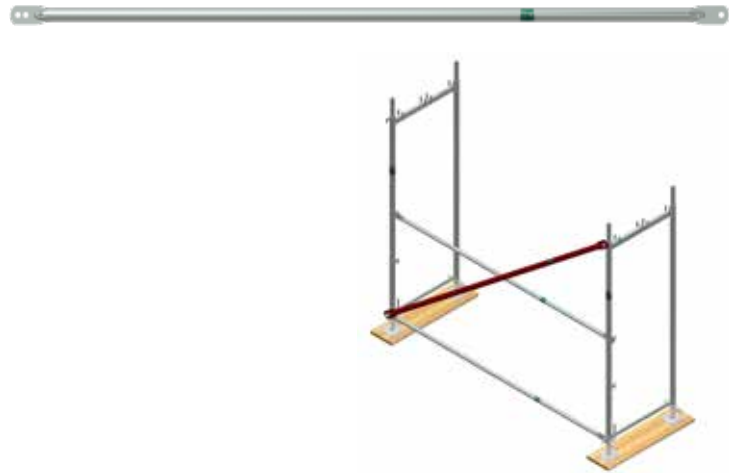

## BASE TRANSOM



- Steel, hot dip galvanized
- Is used to fasten lower diagonal brace

Model	Width (m)	Weight (kg)	Article no.	Price (€)
2-board	0,65	1,50	001044	19,00
3-board	1,00	2,50	001045	21,20



## CROSS DIAGONAL



- Steel, hot dip galvanized
- With two half couplers
- For power full bracing assembly frame vertical to the facade and for supporting brackets

Model	Length (m)	Weight (kg)	PU (pcs.)	Article no.	Price (€)
2-board	1,77	5,30	50	000588	53,10
3-board	1,95	5,80	50	000587	55,90

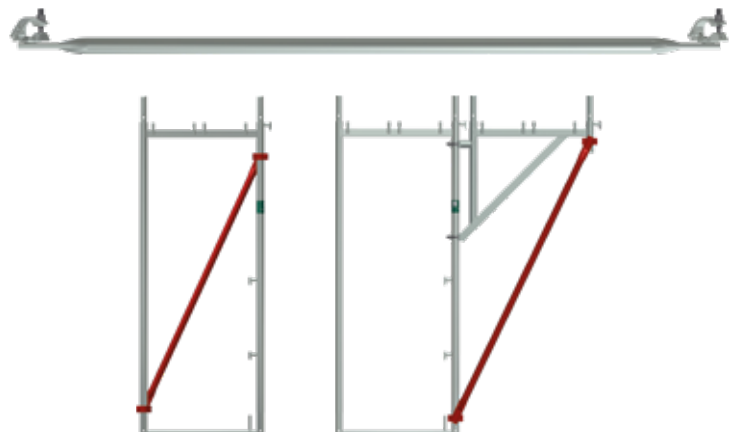

**GUARD RAIL** 

- Steel tube Ø 38 mm (4.00 m length, Ø 42.4 mm), hot dip galvanized
- Compressed and perforated at the ends
- Time-saving attachment via the self-locking swivel pins
- Therefore no tools required for installation



Length (m)	Weight (kg)	PU (pcs.)	Article no.	Price (€)
0,65	1,20	100	011936	16,10
1,00	1,90	100	011938	16,70
1,50	2,80	100	011941	19,10
2,00	3,60	100	011942	19,70
2,50	4,50	100	011943	21,00
3,00	5,40	100	011944	23,00
4,00	11,80	100	007822	47,30

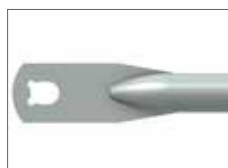

**INSIDE GUARD RAIL POST WITH TOE BOARD PIN** 

- Steel, hot dip galvanized
- With two welded swivel pins for attaching additional inner back guard rail to the vertical frame
- Quick installation with wedge lock



Length (m)	Weight (kg)	PU (pcs.)	Article no.	Price (€)
0,95	2,40	100	007735	37,70

**CORNER SWIVEL PIN**

- Steel, hot dip galvanized
- For mounting the side protection in corner areas
- Tool-free installation



Gewicht (kg)	Art.-Nr.	Preis (€)
0,30	011248	14,40

**SWIVEL PIN WITH NUT** 

- For attaching to the vertical frames for mounting a guard rail



Gewicht (kg)	Art.-Nr.	Preis (€)
0,10	000169	7,80

## RAILING BRACKET

- Steel, hot dip galvanized
- No tools required for installation
- Secure mounting bracket for railing attachment
- Use in combination with 'UN corner swivel pin (item no. 011248) for mounting the railings at internal corners
- Easy interlocking of the two railings
- Automatic securing thanks to intelligent recesses



Weight (kg)	PU (pcs.)	Article no.	Price (€)
0,18	25	016657	11,50

## END GUARD RAIL 1-BOARD



- Steel tube, hot dip galvanized
- Double side protection at the ends
- Plugged into each other
- Can be used for side protection on round scaffoldings



Weight (kg)	PU (pcs.)	A/F	Article no.	Price (€)
2,60	19	50	009366	29,20

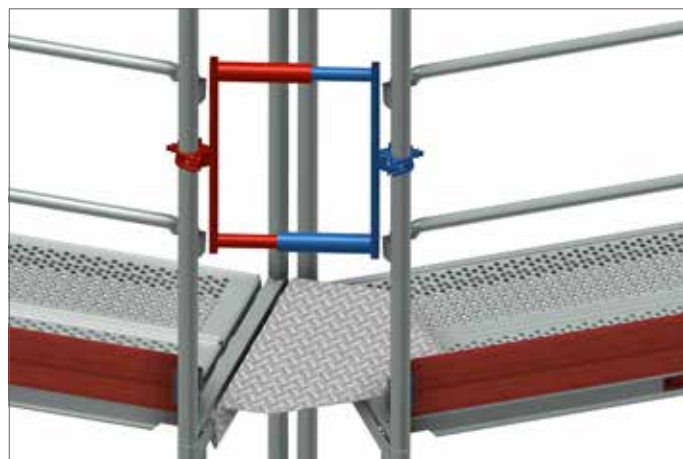
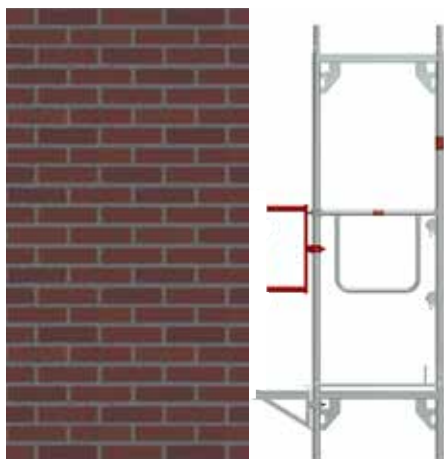

## TOE BOARD



- Timber
- Galvanized steel fittings
- To plug between the frames

Length (m)	Weight (kg)	PU (pcs.)	Article no.	Price (€)
0,65	2,00	70	001109	19,10
1,00	2,50	70	001108	20,50
1,50	3,00	70	001107	22,40
2,00	5,00	70	001106	24,60
2,50	5,50	70	001105	26,40
3,00	6,50	70	001104	29,30
4,00	10,00	70	002616	64,40



**INDIVIDUAL COLOR AND PRINT ON REQUEST**

## TOP END GUARD FRAME



- Steel tube  $\varnothing$  48.3 mm, hot dip galvanized
- Double side guards and deck fastening for the top scaffold platform

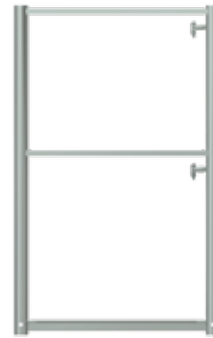

Height (m)	Width (m)	Weight (kg)	PU (pcs.)	Article no.	Price (€)
1,00	0,65	11,50	25	001046	70,60
1,00	1,00	13,50	25	001047	76,00

## GUARD RAIL POST WITH TRANSOM



- Steel tube  $\varnothing$  48.3 mm, hot dip galvanized
- With fastening screw
- For mounting guard rail on the top scaffold level



Height (m)	Width (m)	Weight (kg)	PU (pcs.)	Article no.	Price (€)
1,00	0,65	5,50	50	001050	42,10
1,00	1,00	7,00	50	001051	51,10

## GUARD RAIL POST



- Steel tube  $\varnothing$  48.3 mm, hot dip galvanized
- With fastening screw
- For mounting guard rail on the top scaffold level
- With welded steel brackets to stabilize deck for bracket with tube connector 0.30 m wide



Height (m)	Weight (kg)	PU (pcs.)	Article no.	Price (€)
1,05	4,20	50	001048	27,50

**GUARD RAIL POST FOR ROOF GUARD**



- Steel tube Ø 48.3 mm, hot dip galvanized
- With fastening screw
- For use on vertical frames 0.65 and 1.00 m width
- For securing the top deck level and fastening roof guard nets
- Also suitable for attachment of protective side nets in conjunction with guard rails
- Approved for the setting up of guard and roofguard scaffolds as per DIN 4420

Height (m)	Width (m)	Weight (kg)	PU (pcs.)	Article no.	Price (€)
2,00	0,65	11,00	50	001145	83,20
2,00	1,00	12,50	50	001146	87,50



**GUARD RAIL FOR PROTECTIVE NET**



- Steel tube Ø 48.3 mm, hot dip galvanized
- With fastening screw
- For bracket with tube connector 0.30 m wide
- Not suitable for roof guard scaffolds

Height (m)	Weight (kg)	PU (pcs.)	Article no.	Price (€)
1,60	6,00	50	001153	40,00
2,00	9,00	50	001185	53,00



**REINFORCEMENT FOR ROOF RAIL**



- Steel, hot-dip galvanized
- With three half couplers
- To reinforce the guard rail post for roof guard for a bay length of 4.00 m

Höhe (m)	SW	Gewicht (kg)	Art.-Nr.	Preis (€)
1,30	22	7,50	010063	55,00

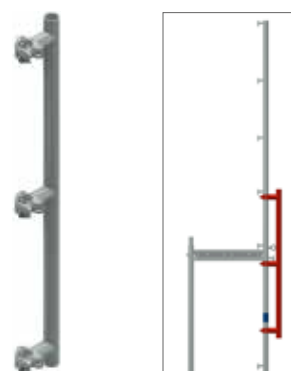

**DOUBLE END GUARD RAIL**



- Steel tube Ø 33.7 mm, hot dip galvanized
- Double side guards at the ends
- Connected on one side of the swivel pin and attached to the opposite side

Width (m)	A/F	Weight (kg)	PU (pcs.)	Article no.	Price (€)
0,65	19	3,00	25	001036	31,30
0,65	22	3,00	25	006948	31,30
1,00	19	4,00	25	001038	33,80

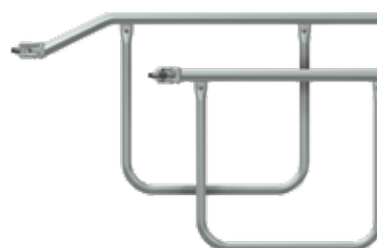

## WALL TIE



- Steel tube  $\varnothing$  48.3 mm, hot dip galvanized
- Installation as short scaffold tie with one standard coupler
- Installation as long scaffold tie with two standard couplers

Length (m)	Weight (kg)	Article no.	Price (€)
0,30	1,40	000240	13,00
0,40	1,80	000242	14,40
0,50	2,00	000125	15,10
0,60	2,60	000241	16,40
0,80	3,20	000129	18,40
1,00	3,80	000127	20,40
1,30	4,80	000131	21,40
1,50	5,50	000132	24,70



## WALL TIE WITH PLATE



- Steel tube  $\varnothing$  48.3 mm, hot dip galvanized
- Installation with a standard coupler

Length (m)	Weight (kg)	Article no.	Price (€)
0,70	2,70	000124	23,30



## WALL TIE



- Steel tube  $\varnothing$  48.3 mm, hot dip galvanized
- Hook is welded at the inside
- Enables optimised connection of scaffold couplers close to the facade in conjunction with ETICS anchor bridge



Length (m)	Weight (kg)	Article no.	Price (€)
0,18	0,95	009190	15,30

## ANCHOR BRIDGE THERMAL INSULATION COMPOSITE SYSTEM



- Set with WDVS bridge and two eye bolts
- For the anchoring of scaffolding to house walls, especially for WDVS
- Even with a lever arm of 28 cm a sufficient load capacity is guaranteed
- parallel to the house wall



Weight (kg)	Article no.	Price (€)
3,61	009141	84,60

## EYE BOLT Ø 12 MM

EN

- Galvanized and welded
- For use with plastic expansion plugs 70/100 mm and plastic caps natural / black

Length (m)	Thread Length (mm)	Weight (kg)	PU (pcs.)	Article no.	Price (€)
90	54	0,155	150	000358	1,50
120	65	0,175	150	000359	1,70
160	58	0,210	100	000360	1,90
190	65	0,235	100	000363	2,10
230	65	0,265	100	000361	2,20
300	65	0,300	50	002374	2,50
350	65	0,364	50	000362	2,70
400	65	0,424	50	006333	6,00
450	65	0,468	50	007555	6,20
500	65	0,530	50	002983	7,50



## EYE BOLT M12

EN

- Galvanized and welded
- With metric thread

Length (m)	Thread Length (mm)	Weight (kg)	PU (pcs.)	Article no.	Price (€)
60	35	0,140	150	012379	5,00
80	35	0,150	150	012383	5,10
100	35	0,160	100	012384	5,20
120	35	0,175	100	012385	5,40
160	35	0,210	100	012386	5,60
220	35	0,260	50	012387	5,90



## PLASTIC CAP



EN

- For closing anchor drill holes

Colour	Weight (kg)	PU (pcs.)	Article no.	Price (€)
natural	0,003	100	000651	0,20
black	0,003	100	010353	0,20



## EXPANSION PLUG



EN

- For eye bolts with a timber thread Ø 12 mm
- For drilling Ø 14 mm

Length (m)	Weight (kg)	PU (pcs.)	Article no.	Price (€)
0,07	0,007	100	000357	0,40
0,10	0,007	100	011158	0,40



## MJ-SCAFFY



- Screw-in aid for eye bolts
- With socket A/F 22 (for standard ratchet wrenches)
- With 3/4 inch square socket
- With SDS drill adapter



Weight (kg)	Article no.	Price (€)
0,374	012600	70,60

## COUPLER BRACKET WITH TUBE CONNECTOR



- Steel, hot dip galvanized
- With welded half coupler
- With tube connector for intake from guard rail posts
- To expand the scaffold by 0.30 m

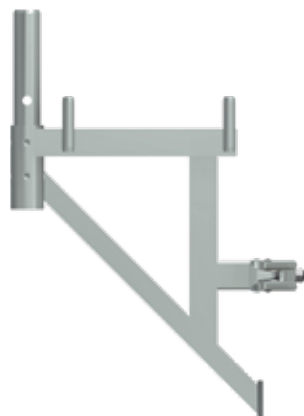

Width (m)	A/F	Weight (kg)	PU (pcs.)	Article no.	Price (€)
0,30	22	4,20	20	006943	43,10
0,30	19	4,20	20	001052	43,10

## COUPLER BRACKET WITHOUT TUBE CONNECTOR



- Steel, hot dip galvanized
- With welded half coupler
- To expand the scaffold by 0.30 m



Width (m)	A/F	Weight (kg)	PU (pcs.)	Article no.	Price (€)
0,30	22	3,00	100	006944	39,30
0,30	19	3,00	100	001053	39,30

## BRACKET 0.15 M



- Steel, hot dip galvanized
- Without tube connector
- With welded half coupler
- Easy to use with board securing
- Used to extend the scaffold on the inside by one 0.15 m wide system deck



Width (m)	Weight (kg)	A/F	PU (pcs.)	Article no.	Price (€)
0,15	1,80	22	150	013958	40,00

## HOP-UP BRACKET 2-BOARD WITH TUBE CONNECTOR



- Steel, hot dip galvanized
- With half couplers
- To widen 0.65 m, the inside and outside of the scaffold to extend the ends
- When extending scaffold on hop-up brackets, please request load tables

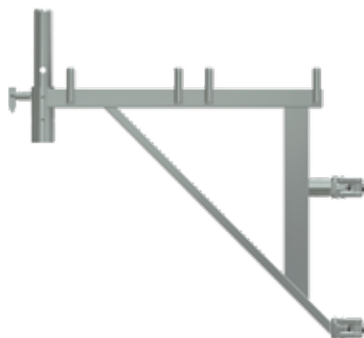

Width (m)	A/F	Weight (kg)	PU (pcs.)	Article no.	Price (€)
0,65	22	7,60	20	006950	75,50
0,65	19	7,60	20	001054	75,50

## HOP-UP BRACKET 2-BOARD WITHOUT TUBE CONNECTOR



- Steel, hot dip galvanized
- With one half coupler
- Without tube connector
- To widen 0.65 m, the inside and outside of the scaffold to extend the ends
- When extending scaffold on hop-up brackets, please request load tables

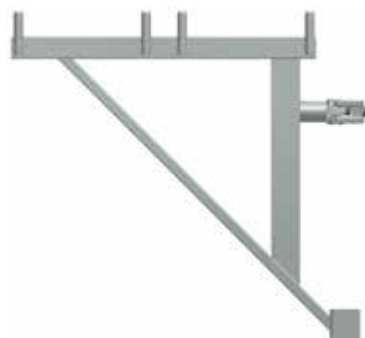

Width (m)	A/F	Weight (kg)	PU (pcs.)	Article no.	Price (€)
0,65	19	5,70	20	010643	73,30

## FRAME BRACKET 2-BOARD



- Steel, hot dip galvanized
- With half couplers
- With tube connectors
- The frame bracket is used to make scaffold lift adaptations of one frame width
- Unlike the hop-up bracket, the adaptation is not only possible at the standard decking height but can be made at any required height
- This makes it possible to optimally adjust the scaffold to the shape of the building
- 2-board model for vertical frame UNI TOP 65



Width (m)	A/F	Weight (kg)	PU (pcs.)	Article no.	Price (€)
0,65	19	9,10	20	001056	95,90

## GRID BRACKET 0.50 M



- Steel, hot dip galvanized
- With half coupler
- With tube connector
- To expand or shorten scaffold bays



Width (m)	A/F	Weight (kg)	PU (pcs.)	Article no.	Price (€)
0,50	22	6,00	35	007129	56,10

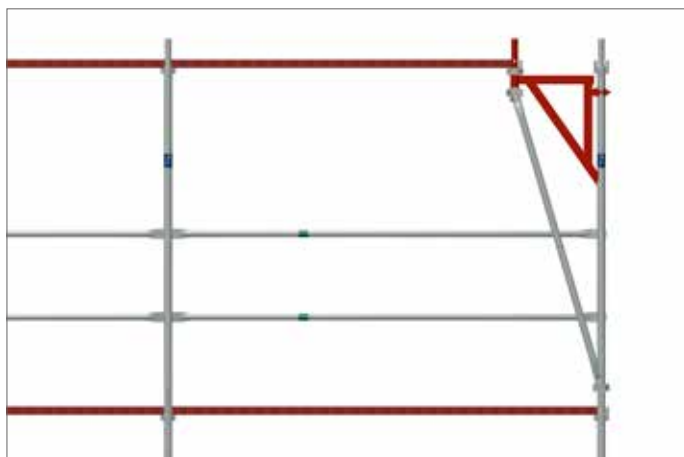

## HOP-UP BRACKET 3-BOARD



- Steel, hot dip galvanized
- With half coupler
- With tube connector
- To expand the inside and outside of the scaffold by 1.00 m and to extend the ends
- Bracket  $\leq$  load class 3
- To support the cross diagonal is to be installed
- Stability of the supporting structure must be verified in each individual case

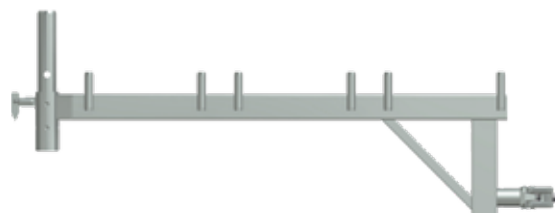

Breite (m)	SW	Gewicht (kg)	VPE (Stk.)	Art.-Nr.	Preis (€)
1,00	19	7,30	20	001055	95,60

## SUPPORTING CONSOLE 3-BOARD HEAVY VERSION



- Steel, hot dip galvanized
- With two half couplers
- Extended tube connector enables the use of a starting transom, to widen or shorten the bay size by 1.00 m
- Console ≤ load class 3
- To support the cross diagonal is to be installed
- Stability of the supporting structure must be proven in each individual case

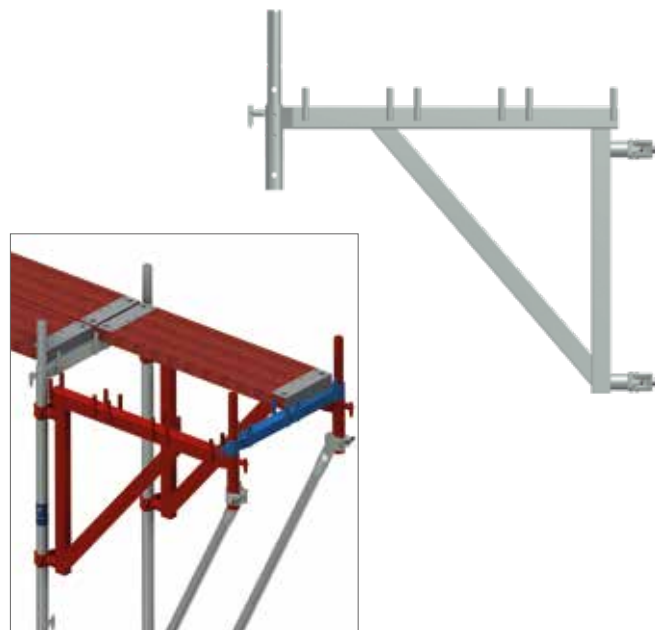

Width (m)	A/F	Weight (kg)	PU (pcs.)	Article no.	Price (€)
1,00	19	11,50	20	009076	121,60

## FRAME BRACKET 3-BOARD



- Steel, hot dip galvanized
- With half coupler
- With tube connector for further construction with a 3-board steel vertical frame
- The frame bracket is used to make scaffold lift adaptations of one frame width
- To support the cross diagonal is to be installed
- Stability of the supporting structure must be verified in each individual case

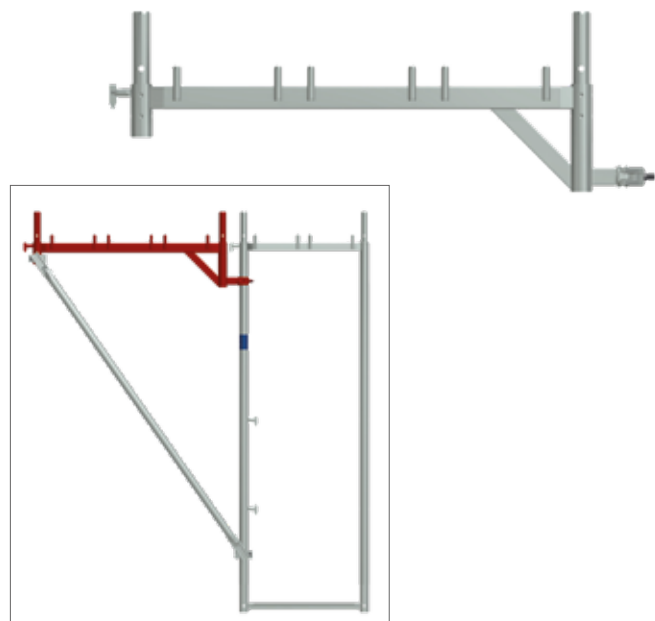

Width (m)	A/F	Weight (kg)	PU (pcs.)	Article no.	Price (€)
1,00	19	8,00	20	001058	113,50

**YOU WILL FIND BRACKETS ASPIRATIONS ON PAGE 17.**

## ROOF GUARD EXTENSION



- Steel, hot dip galvanized
- For the construction of a protective roof according to DIN 4420
- In conjunction with bracket 0.64 m or bracket 0.96 m use with deck fastener



Width (m)	Weight (kg)	Article no.	Price (€)	
0,65	3,00	002240	32,20	🕒

## DECK FASTENER



- Steel, hot dip galvanized
- Suitable for roof guard extension
- In conjunction with 2-board (Article no. 001180) or 3-board (Article no. 001171) hop-up bracket



Model	Weight (kg)	Article no.	Price (€)	
2-board	3,40	001180	46,70	🕒
3-board	4,00	001171	51,20	🕒

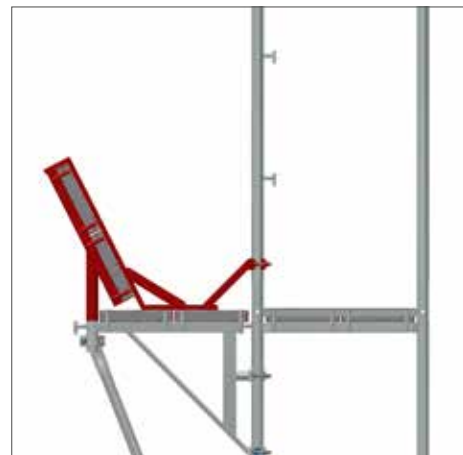
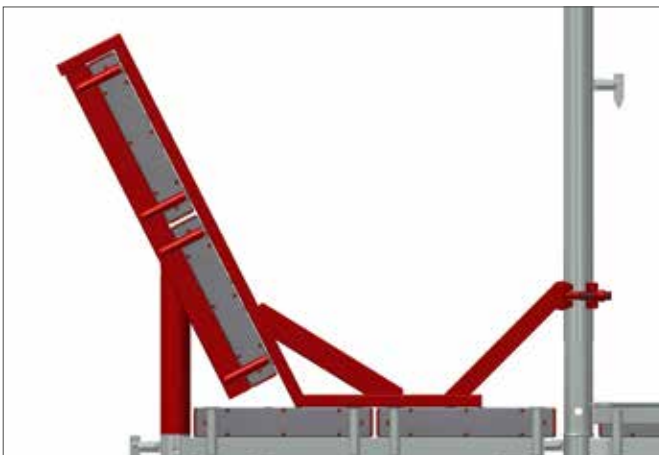

## ALUMINUM STAIR WITH PLATFORM



- Bay height 2.00 m
- Scaffold stairway for the planned construction with facade scaffoldings
- For quick and safe mounting of the scaffold levels
- The steps are designed in a non-slip manner and allow comfortable outside access for extensive use of scaffold and when transporting material, without reducing the work surface in the main walkway
- Evenly distributed area load  $p = 2.5 \text{ kN/m}^2$
- Single load distributed on  $0.2 \times 0.2 \text{ m}^2 F = 1.5 \text{ kN}$
- Meets the requirements according to DIN EN 12811-1



Field length (m)	Length (m)	Width (m)	Weight (kg)	PU (pcs.)	Article no.	Price (€)
2,50	3,25	0,55	20,00	10	000394	501,60

**Individual customer identification possible.**



## OUTSIDE STAIRCASE HANDRAIL



- Steel, hot dip galvanized
- For aluminum platform stairs
- For mounting on swivel pins

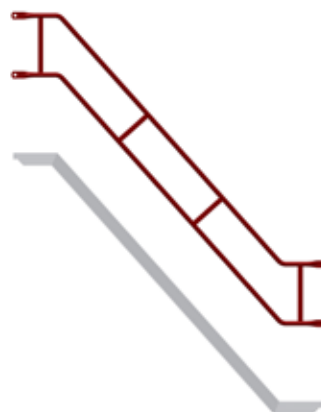

Field (m)	Length (m)	Weight (kg)	PU (pcs.)	Article no.	Price (€)
2,50	3,45	16,00	40	000426	150,90

## INSIDE STAIRCASE HANDRAIL



- Steel, hot dip galvanized
- For aluminum platform stairs
- Can be used for field wide 2.50 and 3.00 m
- For mounting to the stair string
- Integrated end plug on the handrail for protection



Length (m)	Weight (kg)	A/F	PU (pcs.)	Article no.	Price (€)
2,25	11,50	19	20	000425	137,80
2,25	11,50	22	20	006942	137,80

## ROUND INSIDE GUARD RAIL



- Steel, hot dip galvanized
- For aluminum platform stairs
- For mounting to the stair string

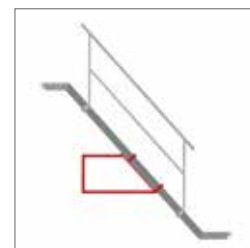

Weight (kg)	A/F	PU (pcs.)	Article no.	Price (€)
5,80	19	30	009226	69,60

## GUARD RAIL BRACKET FOR PLATFORMS STAIRS



- Steel, hot dip galvanized
- With tube connector
- With welded coupler
- Reduces the guard rail width by 0.50 m, e. g. from 2.57 to 2.07 m to make the passage to the stairs



Length (m)	A/F	Weight (kg)	Article no.	Price (€)
0,50	19	3,20	008227	49,20

## GAP COVER WITH HALF COUPLER



- Steel, hot dip galvanized
- Non-slip coating
- Varied use for bridging gaps up to 0.25 m wide
- Quick assembly due to half coupler



Length (m)	Width (m)	A/F	Weight (kg)	Article no.	Price (€)
0,35	0,38	22	4,00	007794	45,80
0,60	0,38	22	6,20	008256	71,60

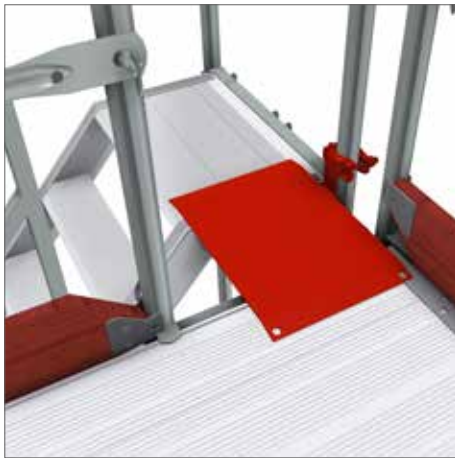

## GRIDDOOR



- Complete protection against unauthorised access to stairways
- Visible separation between construction site and surroundings
- Assembly and fixing thanks to sliding coupling connection points
- Mesh door for all scaffolding widths thanks to flexible coupling connections

Height (m)	Width (m)	Weight (kg)	Article no.	Price (€)
1,70	0,85	13,00	014603	179,00

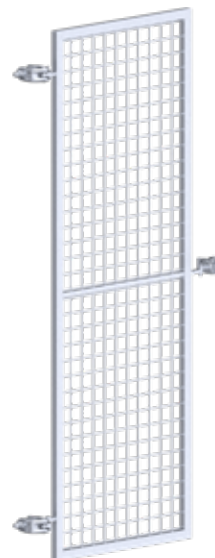

## STEP ACCESS PLATFORM



- Steel, hot dip galvanized
- Non-slip deck
- With two tube connectors, axial dimension 175 mm
- With two welded couplers
- To set up a stairway in front of a scaffold field
- Reduces the guard rail width by 0.50 m, e.g. from 2.50 to 2.00 m to create the passage to the stairs



Length (m)	Width (m)	Weight (kg)	A/F	PU (pcs.)	Article no.	Price (€)
0,50	0,30	7,50	22	14	000234	91,80

## ALUMINUM BEGINNING STAIRS WITH PLATFORM



10

- Beginning stair with integrated base jack mounts
- Scaffold stairway for the planned construction with facade scaffolding
- For quick and safe mounting of the scaffold levels
- The steps are designed in a non-slip manner and allow comfortable outside access for extensive use of scaffold and when transporting material, without reducing the work surface in the main walkway



Field height (m)	Length (m)	Width (m)	Weight (kg)	PU (pcs.)	Article no.	Price (€)
1,00	1,50	0,55	11,10	10	007362	299,70

## STAIR GUARD RAIL



- Steel, hot dip galvanized
- For aluminum beginning stair with platform 1.00 m



Weight (kg)	Article no.	Price (€)
11,50	014964	135,70

## ACCESS LADDER 1.00 M



- Steel, hot dip galvanized
- System-related suspension
- Enables easy entry into the scaffold, with a field height of 1.00 m



Length (m)	Width (m)	Weight (kg)	Article no.	Price (€)
1,00	0,62/0,47	7,30	010434	97,90

## INTERMEDIATE TRANSOM



- Steel, hot dip galvanized
- With two half couplers
- Adjustable height

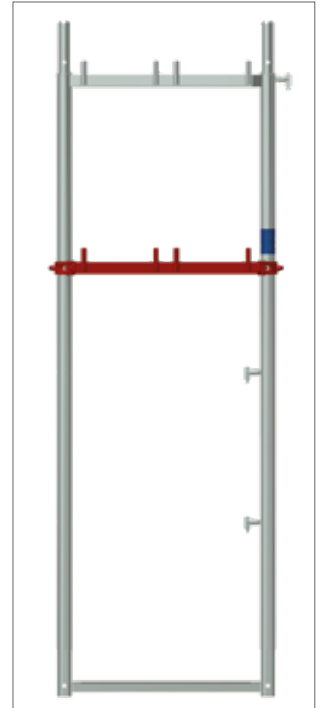
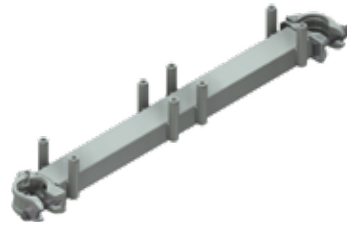

Model	Width (m)	A/F	Weight (kg)	Article no.	Price (€)
2-board	0,65	19	3,50	001086	46,00
3-board	1,00	19	5,20	001087	63,40

## PLATFORM TRANSOM



- Steel, hot dip galvanized
- With two half couplers
- Designed for building a continuous platform level between the scaffolds

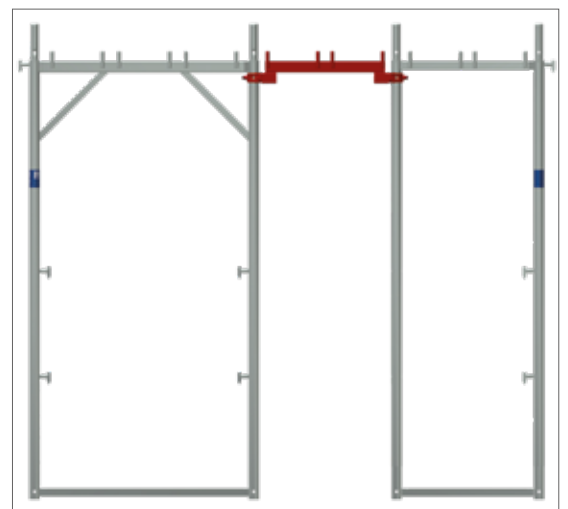
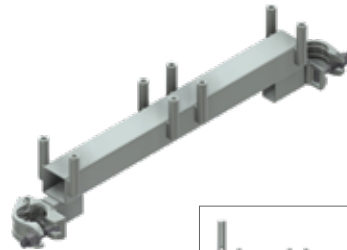

Model	Width (m)	A/F	Weight (kg)	Article no.	Price (€)
1-board	0,35	19	3,00	009638	47,30
2-board	0,65	19	4,30	007578	52,30
3-board	1,00	19	5,70	007579	68,00

## HANGING TRANSOM



- Steel, hot dip galvanized
- With two tube connectors
- For bridging up to a 6.00 m span and cantilevered end elevations up to 3.00 m

Model	Width (m)	Weight (kg)	Article no.	Price (€)
2-board	0,65	4,70	001088	51,80
3-board	1,00	6,30	001089	66,60



## TRANSITION TRANSOM



- Steel, hot dip galvanized
- With tube connectors
- Enables system change from UNI TOP 100 to UNI TOP 65

Width (m)	Weight (kg)	Article no.	Price (€)
1,00	13,50	001093	126,70



## DECK FASTENING WITH WEDGE



- Steel, hot dip galvanized
- For securing decks against lifting off
- With wedge head connection



Weight (kg)	Article no.	Price (€)
0,70	006850	14,60

## BRACKET DECK FASTENING



- Steel, hot dip galvanized
- For securing decks against lifting off



Width (m)	A/F	Weight (kg)	Article no.	Price (€)
0,40	22	1,50	007302	26,60

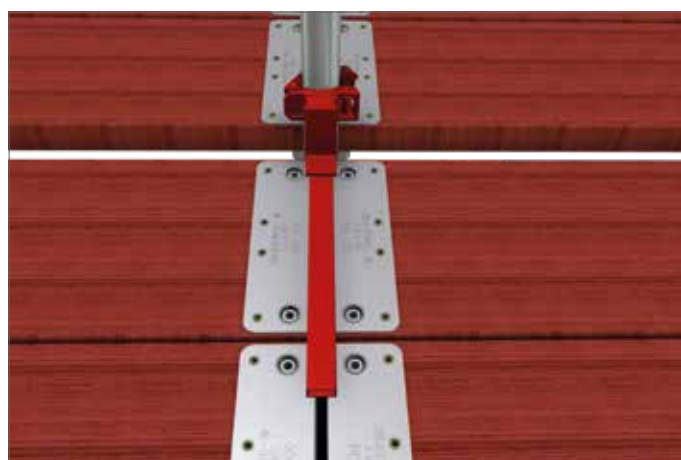

## DECK FASTENING TELESCOPIC



- Steel, hot dip galvanized
- Telescoping 2 -3 board
- For securing decks against lifting off



Width (m)	Weight (kg)	Article no.	Price (€)
0,65 / 1,00	2,90	010784	31,70

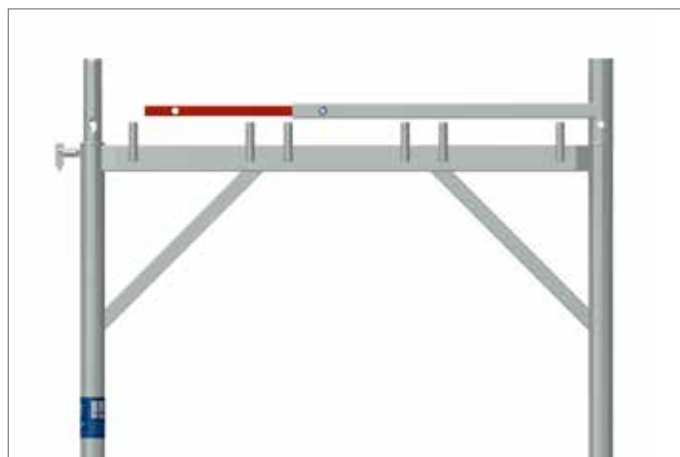

## GAP COVER ALUMINUM



- With plastic cap
- For gap cover between main and console field (5,5 cm - 11,3 cm)
- ATTENTION: floor is to be secured against lifting!
- Deck fastening article no. 009240



Length (m)	Width (m)	Weight (kg)	Article no.	Price (€)
1,50	0,22	2,90	008633	45,60
2,00	0,22	4,00	008634	54,80
2,50	0,22	5,00	008635	63,60
3,00	0,22	6,00	008636	74,70

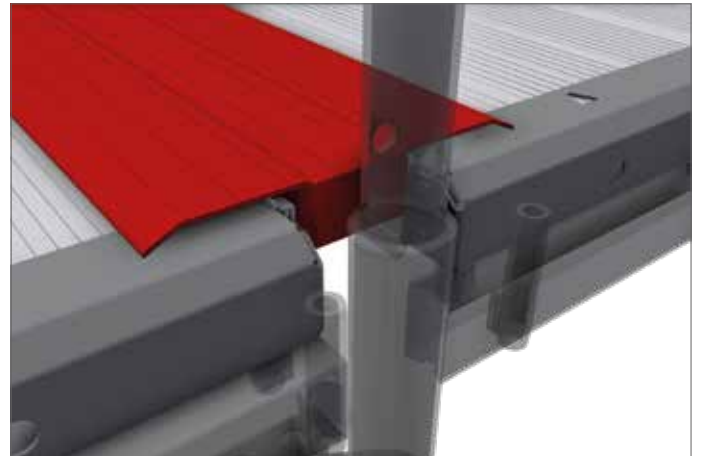

## DOUBLE DECK FASTENER



- Steel, hot dip galvanized
- For preventing decks and gap covers from lifting off

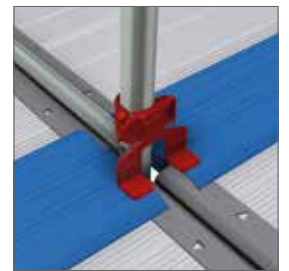

Weight (kg)	A/F	Article no.	Price (€)
1,00	22	009240	18,90

**GAP COVER ALUMINUM**

- Aluminum
- Non-slip deck
- 2-board



Length (m)	Width (m)	Weight (kg)	Article no.	Price (€)
0,60	0,38	2,20	009294	93,80

**POLYGON COVERAGE 2-BOARD** 

- Steel, hot dip galvanized
- Non-slip deck with deck fastening for gap-free construction of round scaffolding from 0 to 50°



Width (m)	Weight (kg)	Article no.	Price (€)
0,61	7,30	008600	84,60

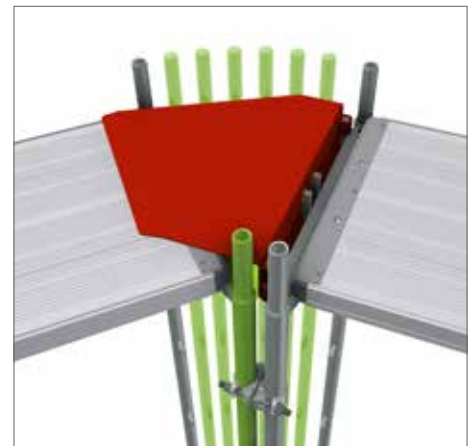

**FURTHER GAP COVERS CAN BE FOUND  
IN OUR PRICE LIST „ACCESSORIES“.**

## ROOFER BRACKET



- Steel, hot dip galvanized
- With two Tube connectors
- Meets different requirements for ergonomic workplaces for painters and tinsmiths
- For use up to load class 3
- Not to be used as roof safety scaffold

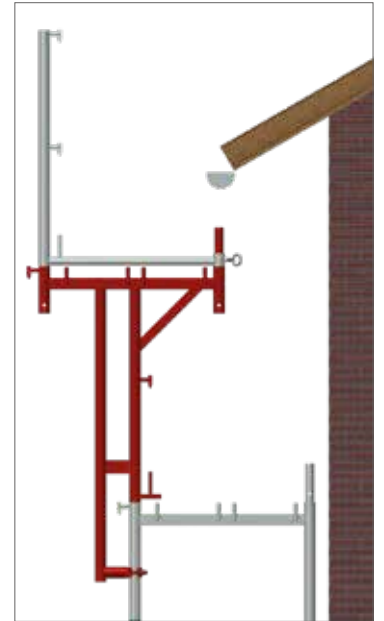

Width (m)	Weight (kg)	Article no.	Price (€)
0,65	15,70	001068	175,30

**SPINDLE SECURITY**



- Steel, hot dip galvanized
- With half coupler
- Secures base jacks and swivel castors with spindle when moving scaffolding units with a crane

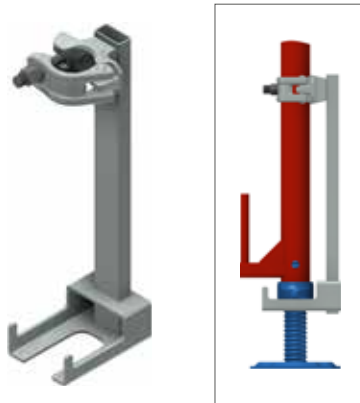

Height (m)	Weight (kg)	A/F	PU (pcs.)	Article no.	Price (€)
0,40	2,00	19	200	010294	30,20

**CASTOR WITH SPINDLE**



- Bearing 10 kN with central load distribution
- Castor Ø 200 mm made of polyamide with run stop
- Levelling through adjustable steel spindle
- The DIN 4420-3 applies when a rolling towers made of a scaffolding
- A standard proof of stability is required for this mobile scaffold



Weight (kg)	PU (pcs.)	Article no.	Price (€)
7,00	80	000332	102,50

**HEAD JACK**

- Steel, hot dip galvanized
- Supporting element for support and platform scaffolding as well as for formwork scaffolds
- Used to hold squares timbers, laminated beams and formwork beams



Opening dimension (mm)	Weight (kg)	PU (pcs.)	Article no.	Price (€)
148	5,60	150	000693	40,60
180	8,30	-	011537	49,90

**SECURITY PIN**



- Steel, hot dip galvanized
- Ø 9 mm
- For securing the scaffold joints against unintentional lift-off



Weight (kg)	PU (pcs.)	Article no.	Price (€)
0,12	100	000508	1,40

**ADJUSTMENT TUBE**



- Steel, hot dip galvanized
- Adjustment range 10 x 0.10 m = 1.00 m
- For levelling unequal ground
- Use in connection with a decking transom and base jack

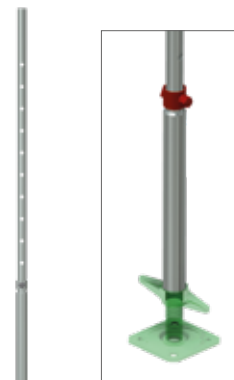

Height (m)	Weight (kg)	Article no.	Price (€)
1,70	5,80	000402	56,70

## STANDARD COUPLER

EN

- Steel, hot dip galvanized, drop-forged
- Robust model
- For right-angled connection of tubes of  $\varnothing$  48.3 mm
- Class BB, EN 74-1
- To be used in the classes B and BB of the steel and aluminum tube

Thread	A/F	Weight (kg)	PU (pcs.)	Article no.	Price (€)
Standard	22	1,15	25	000325	8,60
Standard	19	1,15	25	000326	8,60
Quick	22	1,15	25	007521	9,30
Quick	19	1,15	25	007523	9,30



## SWIVEL COUPLER

EN

- Steel, hot dip galvanized, drop-forged
- Robust model
- For any angular connection of tubes of  $\varnothing$  48.3 mm
- Class B, EN 74-1
- To be used in the class B of the steel and aluminum tube

Thread	A/F	Weight (kg)	PU (pcs.)	Article no.	Price (€)
Standard	22	1,35	25	000328	9,30
Standard	19	1,35	25	000329	9,30
Quick	22	1,35	25	007522	9,90
Quick	19	1,35	25	007524	9,90



## SPARE PARTS CAN BE FOUND IN OUR PRICE LIST „ACCESSORIES“.

## SCAFFOLD TUBE STEEL

EN

- S235 Steel, hot dip galvanized
- Measurements as per EN 39
- Manufacturing length 6.00 m
- Minimum yield strength 235 N/mm<sup>2</sup>
- Connection of standard couplers allowed
- Special lengths on request

Model (mm)	Length (m)	Weight (kg)	PU (pcs.)	Article no.	Price (€)
48,3 x 3,2	1,00	3,77	61	004548	17,20
48,3 x 3,2	2,00	7,54	61	004550	31,40
48,3 x 3,2	3,00	11,31	61	004552	45,60
48,3 x 3,2	4,00	15,08	61	004554	61,80
48,3 x 3,2	5,00	18,85	61	005619	76,00
48,3 x 3,2	6,00	22,60	61	004087	85,00

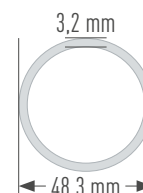

**SWIVEL PIN COUPLER** EN

- Steel, hot dip galvanized, drop-forged
- Half coupler with welded swivel pin for fixing additional back guard rails, e. g. on the inside of the scaffold



Thread	A/F	Weight (kg)	Article no.	Price (€)
Standard	22	0,80	000134	9,90
Standard	19	0,80	002354	9,90
Quick	22	0,81	007436	10,40
Quick	19	0,81	008202	10,40

**MORE COUPLERS  
FIND IN OUR  
PRICE LIST 'ACCESSORIES'**

**DISTANCE COUPLER** DE

- Steel tube Ø 48.3 mm
- With two welded couplers, galvanized
- E. g. as connection between facade scaffold and a forward-placed stair ascent

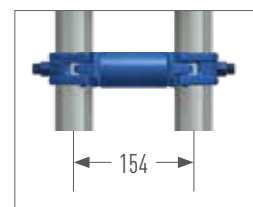

Width (m)	Weight (kg)	A/F	Article no.	Price (€)
0,110	1,60	22	008225	26,00
0,154	1,80	19	008297	26,30
0,180	2,00	22	000233	27,10

## LATTICE BEAM STEEL



- Steel tube  $\varnothing$  48.3 mm, hot dip galvanized
- Load depends on span according to the separate load table

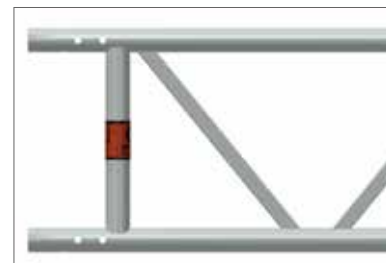

Length (m)	Height (m)	Weight (kg)	PU (pcs.)	Article no.	Price (€)
3,20	0,40	30,00	25	000108	198,50
4,20	0,40	39,00	25	000109	245,80
5,20	0,40	50,00	25	000110	297,80
6,20	0,40	58,00	25	000111	335,40
7,60	0,40	72,00	25	000112	496,30

## LATTICE BEAM ALUMINUM



- Aluminum tube  $\varnothing$  48.3 mm
- Load depends on span according to the separate load table



Length (m)	Height (m)	Weight (kg)	PU (pcs.)	Article no.	Price (€)
3,20	0,40	12,00	25	000255	234,00
4,20	0,40	15,00	25	000257	291,00
5,20	0,40	20,00	25	000258	348,00
6,20	0,40	23,00	25	000259	390,10
8,10	0,40	31,00	25	000261	550,00

## TUBE CONNECTOR FOR LATTICE BEAMS



- Steel, hot dip galvanized
- For the continuous extensions of lattice beams



Model	Weight (kg)	Article no.	Price (€)
Straight	1,30	003588	30,50

## BOLT WITH CUTTER PIN



- Screw-free connection of lattice beams
- Replaces usual screws M 12 x 60 mm there by reducing the assembly time
- Consisting of cotter pin (article no. 002232), bolt (article no. 002235) and washer (article no. 002964)
- All articles are also available separately



Weight (kg)	Article no.	Price (€)
0,09	002237	3,70

**WALL CONNECTION FOR LATTICE BEAM** 

- Steel, hot dip galvanized
- For fastening to the wall, e. g. for bridging constructions
- For lattice beams with 400 mm construction height

Weight (kg)	Article no.	Price (€)
3,50	000170	78,00

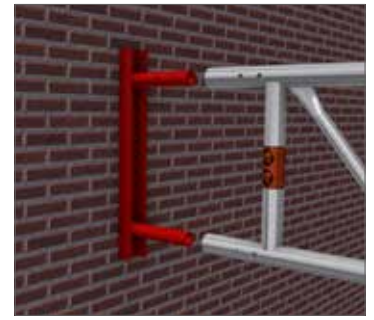

**LATTICE BEAM BASE PLATE** 

- Steel, hot dip galvanized

Model	Width (m)	Weight (kg)	Article-no.	Price (€)	
4-board	1,50	7,00	000973	83,80	
6-board	2,00	9,50	000974	111,90	
8-board	2,50	11,50	000975	139,30	





**LATTICE BEAM BASE PLATE** 

- Steel, hot dip galvanized
- Movable
- Use in connection with a decking transom, for further extensions of scaffold pattern when bridging with lattice beams

Weight (kg)	Article no.	Price (€)
6,00	000235	93,60



**FURTHER ACCESSORIES FOR LATTICE BEAMS YOU CAN FIND IN OUR PRICE LIST 'ACCESSORIES'**

## STACKING PALLET



- Steel tube, hot-dip galvanized
- Specially suited for module scaffolds, e.g. tubes and toe boards
- Open all round
- Suited for stacked and crane transports
- The tube supports are removable and are to be stowed securely in the base frame so that empty pallets can be transported and stacked
- Special designs on request
- Push-on tube with bevel on one side, also available separately (Article no. 005791)



Length (m)	Width (m)	Weight (kg)	PU (pcs.)	Article no.	Price (€)
0,85	0,85	29,00	5	006962	232,20
1,25	0,55	30,00	5	010334	231,90
1,25	0,85	32,43	5	005614	240,20

## SCAFFOLD PALLET FOR VERTICAL FRAME



- Steel tube, hot dip galvanized
- Continuous fork mount for safe fork-lift transport
- Additional cut-outs allow side retracting
- Capacity: 16 Assembly frames

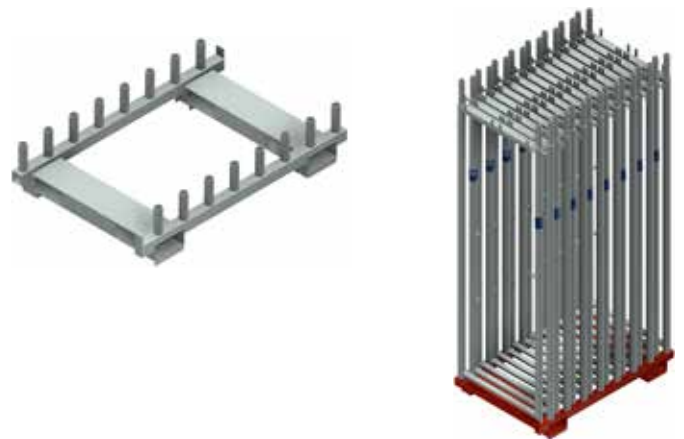

System	Length (m)	Width (m)	Weight (kg)	PU (pcs.)	Article-No	Price (€)
UT 65	1,12	0,74	28,50	5	008363	248,60
UT 100	1,12	1,09	36,10	5	008406	278,60

**MORE PRODUCTS FOR  
STORAGE AND TRANSPORT  
FIND IN OUR  
PRICE LIST 'ACCESSORIES'**



**ASSEMBLY SECURITY GUARD RAIL**

The assembly security guard rail (MSG) serves as a security measure on the top scaffold and in the ascent field. The system consisting of guard rail posts and extendable guard rail spar is mounted in the construction of the scaffold before entering the top scaffold position of the underlying layer.

- Approved by the German Institute for Building Supervision DIBt under the number: Z-8.22-1002.

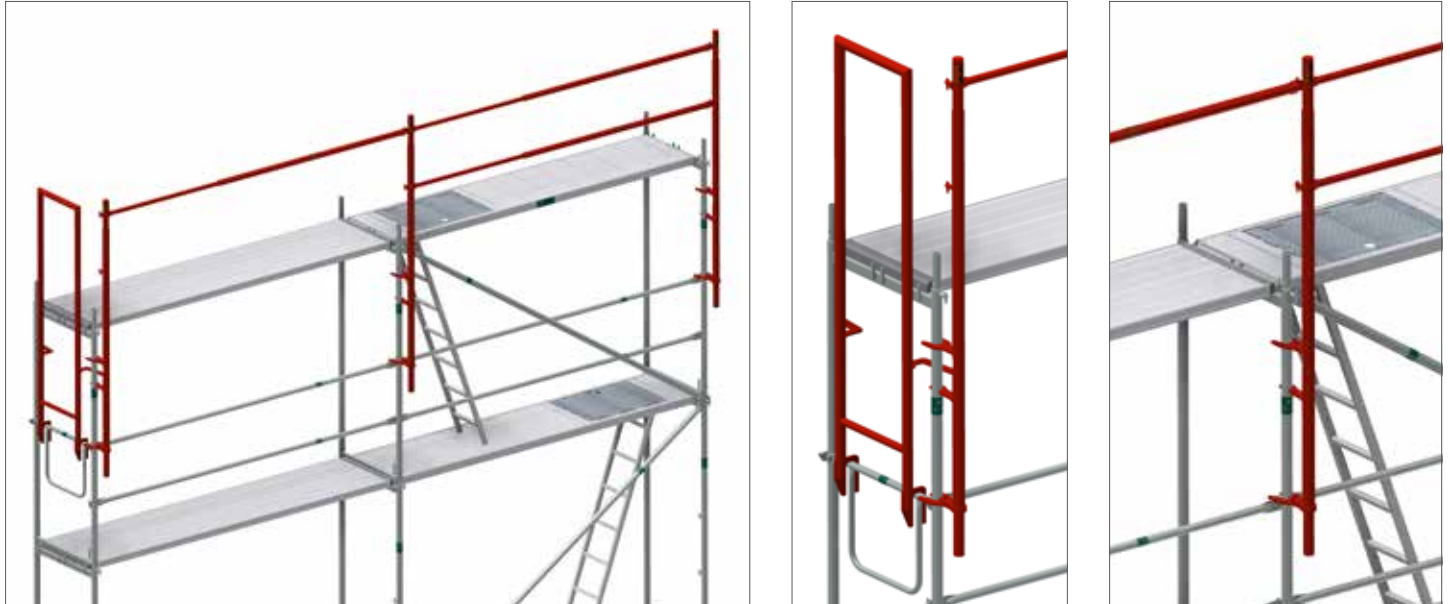

**POST FOR ASSEMBLY SECURITY GUARD RAIL**



- Coaxially arranged aluminum tubes with two swivel pin connections
- Fits any scaffold tube  $\varnothing$  48.3 mm
- Maximum flexibility in the application
- Tool-free fixation through anti-rotation device
- Operation (locking and unlocking) from above and below
- At the same time assembly and disassembly of guard rail and intermediate beam

Weight (kg)	PU (pcs.)	Article no.	Price (€)
5,80	45	011088	251,50



## GUARD RAIL FOR ASSEMBLY SECURITY GUARD RAIL



- Aluminum tube
- Two-sided recesses for attachment to the guard rail post
- Locking pin prevents the unintentional sliding apart of the tubes during transport
- Piston guide belts for smooth sliding of the aluminum tubes



For field length	Weight (kg)	PU (pcs.)	Article no.	Price (€)
1,40 - 1,57 m	3,40	10	011437	133,40
2,00 - 3,07 m	4,60	10	011156	143,90



## FRONT ASSEMBLY SECURITY GUARD RAIL



- Ergonomic, easy to handle and economical to install
- One-piece component as system-free design, no moving parts
- Tool-free installation
- Integrated deadlock
- For easy installation, users stand on the covered position
- Comfortable implementation from below and above

Weight (kg)	PU (pcs.)	Article no.	Price (€)
7,10	10	011131	282,80



**ASSEMBLY SECURITY GUARD RAIL**

The assembly security guard rail (MSG) serves as a security measure on the top scaffold and in the ascent field. The system consisting of guard rail posts and extendable guard rail spar is mounted in the construction of the scaffold before entering the top scaffold position of the underlying layer.



**POST FOR ASSEMBLY SECURITY GUARD RAIL**



- Coaxially arranged aluminum tubes with two swivel pin connections
- Fits any scaffold tube Ø 48.3 mm
- Maximum flexibility in the application
- Tool-free fixation through anti-rotation device
- Operation (locking and unlocking) from above and below
- At the same time assembly and disassembly of guard rail and intermediate beam

Weight (kg)	PU (pcs.)	Article no.	Price (€)
1,40	3,60	011294	158,50



## SET - PERSONAL PROTECTIVE EQUIPMENT MILLER 1

EN N



- Revolution R2 Comfort harness – with 80 cm back eyelet extension (EN 361), elastic dura flex belt band, sharp edge tested, front and rear eyelet, comfort back pads, automatic fasteners for quick on and off, belt end clips, swivel connection at waist height for optimal ergonomics when bending or stretching, attachment point for tools and accessories, integrated label tray, Lifetime of the material is 10 years
- Lanyards with shock absorber - length 2.00 m, sharp edges tested, horizontally approved (attachment point on foot level), 63 mm scaffold hook, stretchy design for more latitude of movement, safety clip for fastening to harness, Teflon-coated for longer life, EN 354 and EN 355
- Equipment bag - 0.27 x 0.80 m (D x H), made of PVC, red



Size	Article no.	Price (€)
S - M	006273	280,00
L - XL	005610	280,00

## SET - PERSONAL PROTECTIVE EQUIPMENT MILLER 2

EN N



- Revolution R2 Comfort harness – with 80 cm back eyelet extension (EN 361), elastic dura flex belt band, sharp edge tested, front and rear eyelet, comfort back pads, automatic fasteners for quick on and off, belt end clips, swivel connection at waist height for optimal ergonomics when bending or stretching, attachment point for tools and accessories, integrated label tray, Lifetime of the material is 10 years
- Twin Manyard EDGE 2.00 m - with 2 x 63 mm aluminum hooks (EN 354 + 355), sharp edges tested, integrated shock absorber with fall of indicator, Lifetime of the material is 10 years
- Equipment bag - 0.27 x 0.80 m (D x H), made of PVC, red



Size	Article no.	Price (€)
L - XL	011284	410,00

**ALL SET COMPONENTS MAY ALSO BE ORDERED SEPARATELY**

## KASK INDUSTRIAL CLIMBING HELMET SUPERPLASMA A0

EN ID N

- Tested and approved according to EN 397
- With chin strap
- Adjusting wheels allow one quick and easy adjustment to the right size
- With ring for attaching the helmet to a belt

Color	Article no.	Price (€)
dark blue	010496	74,60
white	010497	74,60
yellow	010498	74,60
orange	010499	74,60
red	010500	74,60
green	010501	74,60
dark green	010502	74,60
light blue	010503	74,60
black	010453	74,60



## KASK INDUSTRIAL CLIMBING HELMET ZENITH

EN ID N

- Tested and approved according to EN 397 and EN 50365
- Various settings allow a quick and easy adjust
- With ring for attaching the helmet to a belt

Color	Article no.	Price (€)
blue	010504	84,70
white	010505	84,70
yellow	010506	84,70
orange	010507	84,70
red	010508	84,70
green	010509	84,70
black	010510	84,70



**OTHER PROTECTIVE EQUIPMENT FIND IN OUR PRICELIST 'ACCESSORIES'**

SCAFFOLD BAY LENGTH 2.50 M				Length x Height (m)		
				100.00 x 10.20	50.00 x 10.20	10.00 x 10.20
				1,020 m <sup>2</sup> - 40 Fields	510 m <sup>2</sup> - 20 Fields	102 m <sup>2</sup> - 4 Fields
Product description	Dimensions (m)	Article no.	Price (€)	Number (pcs.)	Number (pcs.)	Number (pcs.)

BASE EQUIPMENT						
Vertical frame steel 65	2,00 x 0,65	001019	92,90	164	84	20
Timer deck 0.29 m	2,50 x 0,29	001072	78,90	314	154	26
Access deck with aluminum deck	2,50 x 0,60	003706	380,00	4	4	4
Diagonale	2,50	000080	36,80	32	16	4
Deck transom 2-board	0,65	001082	43,20	2	2	2
Guard rail	2,50	011943	21,00	327	163	32
Toe board	2,50	001105	26,40	160	80	16
Toe board	0,65	001109	19,10	8	8	8
Double end guard rail	0,65	001036	31,30	6	6	6
Guard rail post with transom	1,00 x 0,65	001050	42,10	39	19	3
Top end guard frame	1,00 x 0,65	001046	70,60	2	2	2
Starting transom	0,65	001044	19,00	14	6	0
Base jack	0,60	000320	22,00	82	42	10
Wall tie	0,60	000241	16,40	43	23	7
Standard coupler	SW 19	000326	8,60	43	23	7
Expansion plug	0,07	000357	0,40	43	23	7
Eye-bolt Ø 12 mm	0,12	000359	1,70	43	23	7
Total price (€)				59.244,20	30.627,40	7.775,20

EXTRA CHARGE IN EXCHANGE				1,020 m <sup>2</sup> - 40 Fields		510 m <sup>2</sup> - 20 Fields		102 m <sup>2</sup> - 4 Fields	
FROM	AGAINST	Article no.	Price (€)	Number (pcs.)	Extra charge (€)	Number (pcs.)	Extra charge (€)	Number (pcs.)	Extra charge (€)
Timer deck 0.29 m	Aluminum deck with steel caps	008194	230,00	157	11.335,40	77	4.481,40	13	938,60
Vertical frame steel 65	Vertical frame aluminum	001035	139,00	164	7.560,40	84	4.389,00	20	922,00
Hatches	Stair tower*	-	-	1	2.378,90	1	2.378,90	1	2.378,90

\*The scaffolding components needed for the podium stair tower are summarized in a price and offset against the plowing.

SCAFFOLD BAY LENGTH 3.00 M				Length x Height (m)		
				99.00 x 10.20	51.00 x 10.20	12.00 x 10.20
				1,010 m <sup>2</sup> - 33 Fields	520 m <sup>2</sup> - 17 Fields	122 m <sup>2</sup> - 4 Fields
Product description	Dimensions (m)	Article no.	Price (€)	Number (pcs.)	Number (pcs.)	Number (pcs.)

BASE EQUIPMENT						
Vetical frame steel 65	2,00 x 0,65	001019	92,90	138	72	20
Timer deck 0.29 m	3,00 x 0,29	001071	80,60	258	130	26
Access deck with aluminum deck	3,00 x 0,60	003707	359,00	4	4	4
Diagonale	3,00	000079	40,70	28	16	4
Deck transom 2-board	0,65	001082	43,20	2	2	2
Guard rail	3,00	011944	23,00	270	139	32
Toe board	3,00	001104	29,30	132	68	16
Toe board	0,65	001109	19,10	8	8	8
Double end guard rail	0,65	001036	31,30	6	6	6
Guard rail post with transom	1,00 x 0,65	001050	42,10	32	16	3
Top end guard frame	1,00 x 0,65	001046	70,60	2	2	2
Starting transom	0,65	001044	19,00	12	6	0
Base jack	0,60	000320	22,00	68	36	10
Wall tie	0,60	000241	16,40	36	20	7
Standard coupler	SW 19	000326	8,60	36	20	7
Expansion plug	0,07	000357	0,40	36	20	7
Eye-bolt Ø 12 mm	0,12	000359	1,70	36	20	7
Total price (€)				50.883,20	27.133,20	7.861,40

EXTRA CHARGE IN EXCHANGE				1,010 m <sup>2</sup> - 33 Fields		520 m <sup>2</sup> - 17 Fields		122 m <sup>2</sup> - 4 Fields	
FROM	AGAINST	Article no.	Price (€)	Number (pcs.)	Extra charge (€)	Number (pcs.)	Extra charge (€)	Number (pcs.)	Extra charge (€)
Timer deck 0.29 m	Aluminum deck with steel caps	008195	270,00	129	14.035,20	65	7.072,00	13	1.414,40
Vertical frame steel 65	Vertical frame aluminum	001035	139,00	138	6.361,80	72	3.319,20	20	922,00





[WWW.MJ-SCAFFOLDING.COM](http://WWW.MJ-SCAFFOLDING.COM)



### OPTIMA

Flexible façade scaffolding



### OPTIMA METRIC

Flexible façade scaffolding

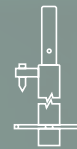

### OPTIMA TOP

Flexible façade scaffolding



### UNI-CONNECT

Frame System 73/109



### UNI

Frame System 70/100



### UNI TOP

Frame System 65/100



### COMBI

Modular System



### WALL AND ROOF

Enclosure



### ACCESSORIES

Universal