



MJ-GERÜST
Scaffolding Systems

**SCAFFOLDING MADE IN
PLETTENBERG**

UNI-CONNECT



PRICES | EDITION 10.2022



SCAFFOLDINGS MADE IN PLETTENBERG

MJ-Gerüst GmbH, based in Plettenberg in the German region of Sauerland, is part of a strong group of companies, which can look back on more than 50 years of company history. The core competence of the family company lies in the production and worldwide distribution of high-quality steel and aluminum scaffolding systems, which offer almost limitless possibilities in the field of modern system scaffolding construction.

With a unique range of products and a wide range of universal accessories, we offer our customers the option of completing existing scaffolding material in a system-compatible complement. A highly valued advantage by our customers that has given our scaffolding international recognition and prominence.

Development, production and sales. These are the cornerstones of our range of services, which are supplemented by numerous additional services. Especially our support in the planning and implementation of difficult projects is claimed. A service in which our technical know-how and experience can often contribute to considerable time and cost savings.

Only through qualified work can a safe quality product be created. Our proven quality management reflects our knowledge and experience and makes the quality of our products measurable. In order to guarantee our high quality standards, our production processes are constantly accompanied by external examination offices and engineers.



OUR COMPANY - YOUR BENEFITS

- Production in Germany at the location Plettenberg
- System compatible, high quality and norm compliant scaffold systems
- Certifications according to DIN EN 9001, 14001 and 50001
- Highest product quality through dynamic quality management
- Short-term availability of material due to high storage capacities and short decision-making processes
- Use of the modern production technology and permanent optimization of technological production running
- Project support already in the planning phase

PARTNER AND CERTIFICATES



The System	04
Base jacks	06
Base ledger	07
Frames	08
Decks	12
Climb up	14
Reinforcement	16
Guard rails	17
Toe boards	18
Upper close-off and roofguard	19
Double end guard rail	24
Anchoring	25
Brackets	28
Climb up, Stairs	33
Gap cover for stairs	35
Stairs	36
Cross ledger	37
Deck fastenings	38
Gap cover	40
End guard rail	41
Brackets	42
Weather protection	43
Rolling tower and castors	44
Head and base attachments	45
Couplers, scaffold tubes	46
Lattice beams	48
The safety enclosure OPTI-BOARD	50
Storage and transport	52
safety during scaffold assembly	53
Scaffold examples	57
Notes	60
Order form	63

 Made in Plettenberg

 Net price, not discountable

 European standard

 Grant BG BAU

 Individual identification

 Delivery time on request

All prices exclude VAT applicable at the time of shipment. All dimensions and weights are non-binding approximate values. Technical data is subject to change without prior notice. Prices are charged as applicable on the day of shipment. Sale is subject exclusively to our sales terms and delivery conditions. An excerpt: place of business and jurisdiction is Plettenberg. Extended retention of title until full payment of all outstanding claims. Our prices are ex works.

UNI-CONNECT: FAST - SAFE - VERSATILE

The wedge lock on the one hand and the U-profile upper cross truss of the vertical frame, in which the scaffold decks are easily hooked on the other hand, make the UNI-CONNECT system easy to use and fast to assembly and disassembly. At the same time these are the essential security features of the system. Thus, the wedge, the connecting element between assembly frame, diagonals and guard rails, by its special inclination and surface texture, a secure and strong clamping action.

The decks are placed in the U-profiles with two or three claws, depending on the width, and ensure that dead load and traffic loads are safely discharged, this reinforces the whole system and results in a firm connection between the individual scaffold bays.

The UNI-CONNECT scaffold system can be used as a guard and roof guard scaffold, and the use of a protective roof is proven in the standard implementation.

Extensive and functionally coordinated accessory components provide the system with flexibility that makes it easy to install even with difficult tasks. UNI-CONNECT is available in both steel and aluminum versions.



EFFICIENT

due to optimized ease of assembly



PROFITABLE

through long life and excellent value retention



FLEXIBLE

through countless field lengths/widths



VERSATILE

through extensive range of accessories



THE ESSENTIAL BENEFITS OF THE SYSTEM IN OVERVIEW

- Scaffold frame with U-profile for flexible mounting of scaffold decks
 - Facilitated partial degradation due to optimized claw geometry
 - Gen. approved by building inspection, also for common, manufacturer independent use.
- For details on type and scope, please refer to the approval models: Z-8.1-872, Z-8.1-922, Z-8.1-935

MJ-Gerüst GmbH
www.mj-geruest.de

Z-8.1-872

Z-8.1-922

Z-8.1-935

DIBt, Berlin

MPA NRW

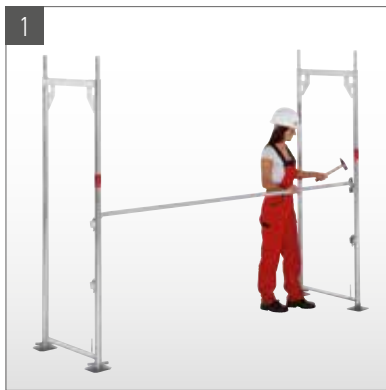

Set up the base jacks, attach assembly frame and connect the guard rails.



Mount vertical diagonal brace, install horizontal brace (only in the diagonal bay).



Mount deck.



Align the scaffold with a spirit level on the guard rail and the vertical frame vertically.

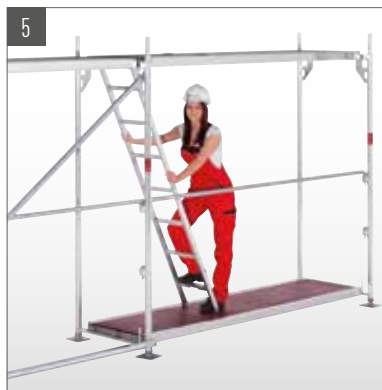

Hang up the interior ladder walkway.



Mount assembly frame and decks of the next layer and hang diagonal, guard rail and toe boards.

Visit us on:



WWW.GERUESTLAGER.DE

BASE JACK EN

- Steel, hot dip galvanized
- With tube spindle
- Base plate 150 x 150 mm
- For adjusting level with differences in height of the underground
- Knurled nut with collar for centring the shaft on the spindle
- Lock to prevent unscrewing of the knurled nut and to ensure the necessary bridging length
- Can be used as a head spindle



Length (m)	Weight (kg)	PU (pcs.)	Article no.	Price (€)
0,30	2,40	375	000318	17,80
0,50	3,10	300	000319	21,30
0,60	3,40	300	000320	22,00
0,78	3,90	250	000321	29,80
1,00	4,70	200	000322	35,70

SWIVEL BASE JACK EN

- Steel, hot dip galvanized
- With tube spindle
- Swiveling base plate 150 x 150 mm
- For adjusting level with differences in height of the underground
- Knurled nut with collar for centring the shaft on the spindle
- Lock to prevent unscrewing of the knurled nut and to ensure the necessary bridging length
- Can be used as a head spindle
- Additional longitudinal scaffold bracing required at in the base
- Permissible load: 25.4 kN



Length (m)	Weight (kg)	PU (pcs.)	Article no.	Price (€)
0,50	3,10	250	000323	46,30
0,80	4,30	200	013292	54,50

UNDERLAY WOODS

- As a load-distributing support
- Sawn
- Dimension +/- 10 mm



Length (m)	Width (m)	Height (m)	Weight (kg)	PU (pcs.)	Article no.	Price (€)
1,00	0,24	0,04	1,50	80	009203	10,20
1,50	0,24	0,04	2,25	80	010360	12,30

BASE LEDGER



- Aluminum
- As lower attachment for the aluminum stairs
- For setting up a deck area in the base section for inside scaffold access



Width (m)	Weight (kg)	Article no.	Price (€)
0,73	3,00	000595	40,00
1,09	5,40	009148	49,20

**YOU WILL FIND MORE PARTS ON PAGE 45
AND OUR PRICE LIST "ACCESSORIES".**

ASSEMBLY FRAME STEEL 70



- Steel tube \varnothing 48.3 mm, hot dip galvanized
- U-profile to mount the decks

Height (m)	Width (m)	Weight (kg)	PU (pcs.)	Article no.	Price (€)
0,66	0,73	10,40	66	000446	78,60
1,00	0,73	12,20	44	000855	86,10
1,50	0,73	15,70	22	000856	87,50
2,00	0,73	17,80	22	000853	88,80



ASSEMBLY FRAME STEEL 100



- Steel tube \varnothing 48.3 mm, hot dip galvanized
- U-profile to mount the decks
- Meets the requirements of width class A/F 09 and is designed for highly loaded scaffolds up to load class 6

Height (m)	Width (m)	Weight (kg)	PU (pcs.)	Article no.	Price (€)
0,66	1,09	13,40	66	000456	95,20
1,00	1,09	15,90	44	000859	101,50
1,50	1,09	20,20	22	000861	110,60
2,00	1,09	23,40	22	000858	111,80



ASSEMBLY FRAME STEEL 70/100



- Steel tube \varnothing 48.3 mm, hot dip galvanized
- U-profile to mount the decks
- With four rail housings for inside and outside guard rails

Height (m)	Width (m)	Weight (kg)	PU (pcs.)	Article no.	Price (€)
2,00	0,73	17,90	22	008095	113,70
2,00	1,09	23,50	22	006817	133,00



008095



006817



TUBE CONNECTOR

Molded tube connector with slim collar for high load-bearing capacity and at the same time optimized stackability.



GUSSED PLATE

Welded corner reinforcement allows play-free fastening of vertical diagonals as well a double coupling connection.

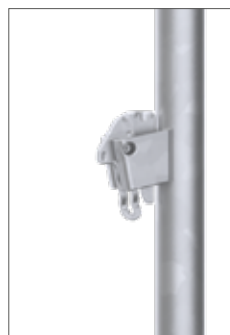

RAIL HOUSINGS

Guard rail support with new, improved wedge geometry for secure positive and non-positive reception of up to two back guard rails.



TOE BOARD HOLDER

Integrated deck fastening protection with toe board holder. Position and geometry ensure a reliable of the lift-off preventer of scaffold decks. A part dismantling of the scaffold is possible at any time.

ASSEMBLY FRAME ALUMINUM 70



- Aluminum tube \varnothing 48.3 mm
- U-profile to mount the decks
- Low dead weight with high strength at the same time

Height (m)	Width (m)	Weight (kg)	PU (pcs.)	Article no.	Price (€)
0,66	0,73	4,20	66	000459	90,90
1,00	0,73	5,40	44	000864	108,80
1,50	0,73	7,70	22	002818	129,90
2,00	0,73	8,60	22	000863	136,30



ASSEMBLY FRAME STEEL 1-BOARD



- Steel tube \varnothing 48.3 mm, hot dip galvanized
- U-profile to mount the decks

Height (m)	Width (m)	Weight (kg)	PU (pcs.)	Article no.	Price (€)
0,66	0,36	8,60	66	000605	95,40
1,00	0,36	10,60	44	000604	98,40
2,00	0,36	18,30	22	000876	100,50



ASSEMBLY FRAME 70/100 FOR ROOF OVERHANG



- Steel tube \varnothing 48.3 mm, hot dip galvanized
- U-profile to mount the decks
- For converting roof overhangs and building protrusions
- Above this frame up to four further scaffold levels are possible

Height (m)	Width (m)	Weight (kg)	PU (pcs.)	Article no.	Price (€)
2,00	0,73	22,00	22	000862	179,80
2,00	1,09	24,00	22	000452	196,60



ROOFGUARD FRAME



- Steel tube Ø 48.3 mm, hot dip galvanized
- For broadening the scaffold UC 70 by one deck width
- Particularly suitable for the construction of roof scaffolding according to DIN 4420
- The transition from UC 70 to UC 100 is easily possible



Height (m)	Width (m)	Weight (kg)	PU (pcs.)	Article no.	Price (€)
2,00	1,09/0,73	24,50	22	011034	125,10

THROUGH-PASSAGE FRAME 1.50 M



- Steel tube Ø 48.3 mm, hot dip galvanized
- Passage for pedestrains and pedestrian protection
- Tube connector for frame widths 0.73 and 1.09 m which can be mounted in different ways
- The reinforcement in longitudinal direction is performed by system diagonals in connection with horizontal braces



Height (m)	Width (m)	Weight (kg)	PU (pcs.)	Article no.	Price (€)
2,20	1,50	35,20	20	003152	253,20

THROUGH-PASSAGE FRAME 1.09 M



- Steel tube Ø 48.3 mm, hot dip galvanized
- Passage width 1.00 m for narrow mounting surface
- Four outer rail housings increase the passage width
- The additionally mounted tube connector enables a continuous construction with the frame 0.73 m



Height (m)	Width (m)	Weight (kg)	PU (pcs.)	Article no.	Price (€)
2,20	1,09	30,70	22	010933	245,30

STEEL DECK OPTI-LINE 0.32 M



- Steel, hot dip galvanized
- Extremely robust, for the toughest operations
- Non-slip surface through pronounced hole profiling
- Reducing the wall thickness and optimized hole profiling
- leads to weight savings
- Good stackability due to the guide grooves at the edges
- Complies with the requirements of DIN EN 12811
- Can be used in guard and roofguard scaffolds as per DIN 4420



**STRONGER DUE TO
NEW SURFACE**



Length (m)	Width (m)	Weight (kg)	Load class	PU (pcs.)	Article no.	Price (€)
0,73	0,32	5,60	6	60/80	008770	66,60
1,09	0,32	7,70	6	60/80	008771	67,80
1,40	0,32	9,30	6	60/80	011731	69,00
1,57	0,32	10,90	6	60/80	008772	69,70
2,07	0,32	13,90	6	60/80	008773	78,20
2,57	0,32	16,90	5	60/80	008774	90,30
3,07	0,32	19,80	4	60/80	008775	102,60
4,14	0,32	31,00	3	60/80	008766	200,50

STEEL DECK 0.19 M



- Steel, hot dip galvanized
- Levelling deck for closing gaps in staging scaffolding and brackets
- Non-slip surface through pronounced hole profiling
- Good stackability due to the guide grooves at the edges



Length (m)	Width (m)	Weight (kg)	Load class	PU (pcs.)	Article no.	Price (€)
0,73	0,19	4,20	6	100/120	008780	47,70
1,09	0,19	6,40	6	100/120	008781	56,70
1,57	0,19	8,50	6	100/120	008782	58,30
2,07	0,19	10,60	6	100/120	008783	67,90
2,57	0,19	12,70	5	100/120	008784	79,40
3,07	0,19	15,90	4	100/120	008785	92,30

ALUMINUM DECK WITH STEEL CAPS 0,61 M



- Non-slip surface and easy to stack
- Optimized ratio of weight and carrying through computerassisted profile optimization
- Steel caps with optimized hanging claws, therefore robust and durable
Patented profile design with beam reinforcements in the running area ensure low deflection and very good slip resistance



Length (m)	Width (m)	Weight (kg)	Load class	PU (pcs.)	Article no.	Price (€)
0,73	0,61	6,80	6	18	006625	131,80
1,09	0,61	8,80	6	18	006627	154,60
1,40	0,61	11,90	6	18	006629	176,10
1,57	0,61	13,40	6	18	006631	175,00
2,07	0,61	14,50	6	18	006632	212,00
2,57	0,61	17,10	5	18	006633	250,40
3,07	0,61	20,30	4	18	006634	284,50

ALUMINUM DECK WITH STEEL CAPS 0,32 M



- Non-slip surface and easy to stack
- Optimized ratio of weight and carrying through computerassisted profile optimization
- Steel caps with optimized hanging claws, therefore robust and durable
Beam reinforcements in the walking area ensure minimal deflection and the greatest possible slip resistance



Length (m)	Width (m)	Weight (kg)	Load class	PU (pcs.)	Article no.	Price (€)
0,73	0,32	3,80	6	18	012323	115,90
1,09	0,32	5,10	6	18	012324	121,80
1,40	0,32	6,30	6	18	012325	124,70
1,57	0,32	6,90	6	18	012326	128,10
2,07	0,32	8,80	6	18	012327	151,10
2,57	0,32	10,70	5	18	012328	173,30
3,07	0,32	12,50	4	18	012329	199,80

ALUMINUM DECK WITH STEEL CAPS 0,19 M



- Non-slip surface and easy to stack
- Optimized ratio of weight and carrying through computerassisted profile optimization
- Steel caps with optimized hanging claws, therefore robust and durable



Length (m)	Width (m)	Weight (kg)	PU (pcs.)	Article no.	Price (€)
0,73	0,19	3,04	18	013791	52,30
1,09	0,19	4,10	18	013792	54,30
1,40	0,19	5,00	18	013793	70,10
1,57	0,19	5,54	18	013794	90,70
2,07	0,19	7,00	18	013795	109,70
2,57	0,19	8,50	18	013796	127,70
3,07	0,19	10,00	18	013797	151,80

COMBI DECK WITH PLYWOOD PANEL



- With water-resistant, non-slip and lightweight plywood panel 12 mm, BFU-100 G-12
- Robust riveted head profiles and steel connections claws, hot dip galvanized

Length (m)	Width (m)	Weight (kg)	Load class	PU (pcs.)	Article no.	Price (€)
0,73	0,61	6,30	3	14	000479	112,60
1,09	0,61	8,40	3	14	003195	126,20
1,57	0,61	13,20	3	14	000481	150,20
2,07	0,61	17,00	3	14	000482	167,50
2,57	0,61	20,00	3	14	000483	191,10
3,07	0,61	23,00	3	14	000484	226,00

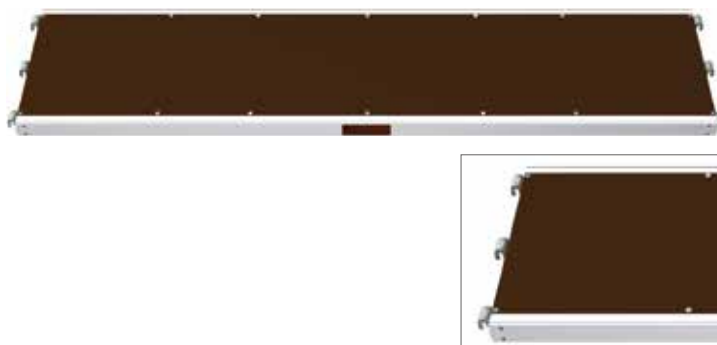

YOU CAN FIND MORE DECKS FOR SPECIAL SOLUTIONS ON PAGE 38.

COMBI ACCESS DECK



- With non-slip deck aluminum
- With integrated aluminum ladder (Length 2.07 m extendable)
- Access flap made of corrugated sheet metal with safety lock, opening to the back
- Easy release of the integrated access ladder, also from the soil surface possible
- Head profiles and optimized connection claws from steel, hot dip galvanized

Length (m)	Width (m)	Weight (kg)	Load class	PU (pcs.)	Article no.	Price (€)
2,07	0,61	23,30	4	14	009872	415,80
2,57	0,61	23,70	4	14	000486	423,80
3,07	0,61	26,70	3	14	000488	473,00



COMBI ACCESS DECK FLAP SIDE



- With non-slip deck aluminum
- With integrated aluminum ladder
- Access flap made of corrugated sheet metal with safety lock, open to the side
- Easy release of the integrated access ladder also from the soil surface possible
- Head profiles and optimized connection claws from steel, hot dip galvanized

Length (m)	Width (m)	Weight (kg)	Load class	PU (pcs.)	Article no.	Price (€)
2,57	0,61	24,20	4	14	006522	473,30
3,07	0,61	27,20	3	14	006523	522,90



COMBI ACCESS DECK WITH PLYWOOD PANEL



- With water-resistant, non-slip and lightweight plywood panel 12 mm, BFU-100 G-12
- With integrated aluminum ladder
- Robust riveted head profiles and steel connections claws, hot dip galvanized

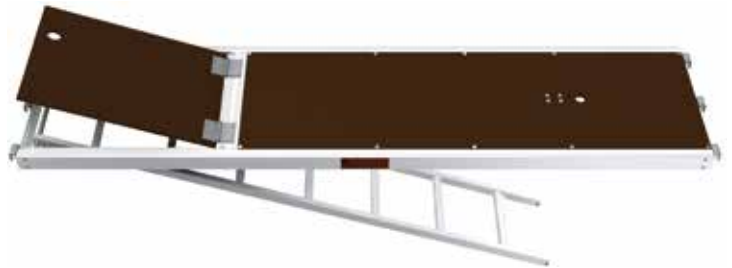

Length (m)	Width (m)	Weight (kg)	Load class	PU (pcs.)	Article no.	Price (€)
2,57	0,61	24,00	3	14	000492	359,10
3,07	0,61	29,00	3	14	000494	409,50

COMBI ACCESS DECK WITHOUT LADDER



- With non-slip deck aluminum
- Without integrated ladder
- Access flap made of corrugated sheet metal with safety look, opening backwards
- Head profiles and optimized connection claws from steel, hot dip galvanized



Length (m)	Width (m)	Weight (kg)	PU (pcs.)	Article no.	Price (€)
1,57	0,61	11,00	14	009079	279,90
2,07	0,61	17,50	14	000490	295,70
2,57	0,61	20,00	14	002250	346,40
3,07	0,61	25,00	14	000489	394,00

ACCESS LADDER



- As a separate ladder for the inside scaffold climbing
- With riveted claws for safe mounting to the access decks



Model	Length (m)	Width (m)	Weight (kg)	PU (pcs.)	Article no.	Price (€)
aluminium	2,16	0,40	3,00	–	001323	80,70
steel	2,16	0,40	10,50	80	000172	79,90

DIAGONAL BRACE 

- Steel tube Ø 42.4 mm, hot dip galvanized
- With swivel wedge coupler
- Strong vertical bracing of the scaffold parallel to the facade



Field (m)	Length (m)	Weight (kg)	PU (pcs.)	Article no.	Price (€)
1,57	2,40	6,00	50	000546	60,30
2,07	2,80	6,50	50	000554	40,80
2,57	3,20	7,00	50	000552	42,80
3,07	3,60	8,30	50	000553	45,60

HORIZONTAL BRACE 

- Steel tube Ø 48.3 mm, hot dip galvanized
- With welded half couplers
- Mounting for bracing in the diagonal bay above the base jack



Field (m)	Length (m)	Weight (kg)	PU (pcs.)	Article no.	Price (€)
1,57	1,57	7,20	50	008207	70,40
2,07	2,07	9,00	50	000548	72,10
2,57	2,57	10,80	50	000550	77,00
3,07	3,07	12,60	50	000551	90,70

CROSS DIAGONAL 

- Steel, hot dip galvanized
- With two half couplers
- For bracing assembly frame vertical to the facade and for supporting brackets

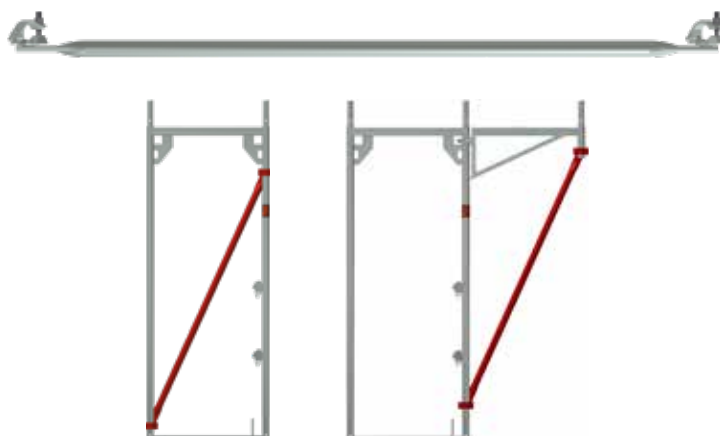

Model	Length (m)	Weight (kg)	PU (pcs.)	Article no.	Price (€)
2-board	1,77	5,30	50	000588	53,10
3-board	1,95	5,80	50	000587	55,90

GUARD RAIL



- Steel tube Ø 33.7 mm, hot dip galvanized

Length (m)	Weight (kg)	PU (pcs.)	Article no.	Price (€)
0,73	1,30	100	000499	18,60
1,09	1,90	100	000500	19,30
1,57	2,80	100	000501	20,10
2,07	3,70	100	000502	21,50
2,57	4,60	100	000503	23,10
3,07	5,50	100	000504	24,60



DOUBLE GUARD RAIL



- Steel tube Ø 33.7 mm, hot dip galvanized

Length (m)	Weight (kg)	PU (pcs.)	Article no.	Price (€)
0,73	4,10	40	000506	41,80
1,09	5,40	40	000507	45,70
1,57	7,20	40	000509	50,20
2,07	9,80	40	000510	54,50
2,57	11,80	40	000511	57,80
3,07	13,50	40	000512	66,50
4,14	21,00	40	000513	118,50



DOUBLE END GUARD RAIL ALUMINUM WITH DIAGONAL STRUTS



- Aluminum tube Ø 40 mm
- Diagonal struts for stability and extra protection

Length (m)	Weight (kg)	PU (pcs.)	Article no.	Price (€)
1,57	3,70	30	009244	72,90
2,07	4,80	30	009660	98,70
2,57	6,50	30	007697	108,30
3,07	7,30	30	007698	124,80



TOE BOARD



- Impregnated timber
- Galvanized steel fittings
- For attaching onto the toe board pins of the assembly frame as a part of the complete three-part side protection

Length (m)	Weight (kg)	PU (pcs.)	Article no.	Price (€)
0,73	1,50	80	000537	16,50
1,09	2,50	80	000538	18,30
1,57	3,00	80	000539	20,10
2,07	4,00	80	000540	21,40
2,57	4,80	80	000541	23,10
3,07	6,50	80	000542	25,10



INDIVIDUAL COLOURS AND PRINTING ON REQUEST

ALUMINUM TOE BOARD



- Aluminum
- Galvanized steel fittings
- For attaching onto the toe board pins of the assembly frame as a part of the complete three-part side protection

Length (m)	Weight (kg)	PU (pcs.)	Article no.	Price (€)
0,73	1,50	80	010142	29,30
1,09	2,00	80	010143	35,10
1,57	2,80	80	010144	40,90
2,07	3,60	80	010145	51,00
2,57	4,40	80	010146	60,80
3,07	5,20	80	010147	70,80
4,14	6,90	80	014000	81,00



END TOE BOARD



- Timber
- Galvanized steel fittings
- For end side protection

Length (m)	Weight (kg)	PU (pcs.)	Article no.	Price (€)
0,73	1,50	100	000544	15,00
1,09	2,00	100	000545	17,20



GUARD RAIL POST



- Steel tube Ø 48.3 mm, hot dip galvanized
- For mounting guard rails, toe boards and fastening scaffolding decks to the top scaffold platform
- Securing against lift-off by security pin

Height (m)	Width (m)	Weight (kg)	PU (pcs.)	Article no.	Price (€)
1,00	0,73	6,50	44	000867	51,10
1,00	1,09	7,30	44	000869	53,40



GUARD RAIL POST ALUMINUM



- Aluminum tube Ø 48.3 mm
- For mounting guard rails, toe boards and fastening scaffolding decks to the top scaffold platform
- Securing against lift-off by security pin

Height (m)	Width (m)	Weight (kg)	PU (pcs.)	Article no.	Price (€)
1,00	0,73	2,80	44	000870	65,00



INSIDE GUARD RAIL POST WITH TOE BOARD PIN



- Steel, hot dip galvanized
- For attaching additional inside guard rails to the assembly frame
- Quick installation with wedge lock

Length (m)	Weight (kg)	PU (pcs.)	Article no.	Price (€)
0,99	3,29	100	006137	41,40



END GUARD RAIL



- Steel tube Ø 48.3 mm, hot dip galvanized
- Forms side guard and deck fastening on the top scaffold platform
- Security against lift off by security pin

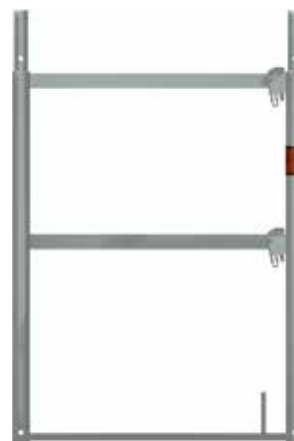

Height (m)	Width (m)	Weight (kg)	PU (pcs.)	Article no.	Price (€)
1,00	0,73	12,00	20	000865	91,60
1,00	1,09	14,70	20	000556	103,00

END GUARD RAIL ALUMINUM



- Aluminum tube Ø 48.3 mm
- Forms side guard and deck fastening on the top scaffold platform
- Security against lift off by security pin



Height (m)	Width (m)	Weight (kg)	PU (pcs.)	Article no.	Price (€)
1,00	0,73	5,30	20	000866	119,30

SINGLE GUARD RAIL POST



- Steel tube Ø 48.3 mm, hot dip galvanized
- With tube connector and short deck fastening
- For use with single-board brackets
- For mounting guard rails, toe boards and fastening scaffolding decks to the top scaffold platform
- Securing against lift-off by security pin



Height (m)	Weight (kg)	PU (pcs.)	Article no.	Price (€)
1,00	5,10	50	000871	37,10

SINGLE GUARD RAIL POST ALUMINUM



- Aluminum tube Ø 48.3 mm
- With tube connector and short deck fastening
- For use with single-board brackets
- For mounting guard rails, toe boards and fastening scaffolding decks to the top scaffold platform
- Securing against lift-off by security pin



Height (m)	Weight (kg)	PU (pcs.)	Article no.	Price (€)
1,00	2,10	50	000872	50,40

SINGLE GUARD RAIL POST



- Steel tube Ø 48.3 mm, hot dip galvanized
- With tube connector
- Without deck fastening
- For holding from two guard rails
- Used when a toe board is not required



Height (m)	Weight (kg)	PU (pcs.)	Article no.	Price (€)
1,00	4,70	50	000873	37,00

GUARD RAIL FOR ROOF GUARD 0.73 M



- Steel tube Ø 48.3 mm, hot dip galvanized
- For use on vertical frames and brackets 0.36, 0.50 and 0.73 m
- For securing the top deck level and fastening roof guard nets
- In conjunction with guard rails, also suitable for attaching toe boards, side protection nets and roof safety nets
- Approved for the setting up of guard and roof guard scaffolds as per DIN 4420

Height (m)	Width (m)	Weight (kg)	PU (pcs.)	Article no.	Price (€)
2,00	0,73	12,00	44	007354	114,80



GUARD RAIL FOR ROOF GUARD 1.09 M



- Steel tube Ø 48.3 mm, hot dip galvanized
- For securing the top deck level and fastening roof guard nets
- In conjunction with guard rails, also suitable for attaching toe boards, side protection nets and roof safety nets
- Approved for the setting up of guard and roofguard scaffolds as per DIN 4420

Height (m)	Width (m)	Weight (kg)	PU (pcs.)	Article no.	Price (€)
2,00	1,09	14,00	44	000563	120,00



GUARD RAIL POST 2.00 M



- Steel tube \varnothing 48.3 mm, hot dip galvanized
- With tube connector and short deck fastening
- Its use in guard and roof guard scaffolds is only permitted with reinforcement



Height (m)	Weight (kg)	PU (pcs.)	Article no.	Price (€)
2,00	9,50	50	000875	76,80

REINFORCEMENT FOR ROOF RAIL



- Steel, hot-dip galvanized
- With three half couplers
- To reinforce the guard rail post 2.00 m



Height (m)	Weight (kg)	A/F	Article no.	Price (€)
1,30	7,50	22	010063	55,00

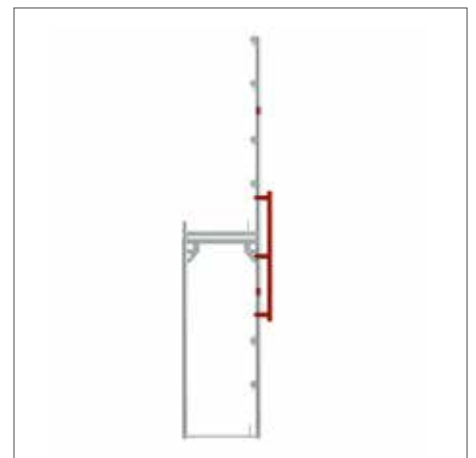
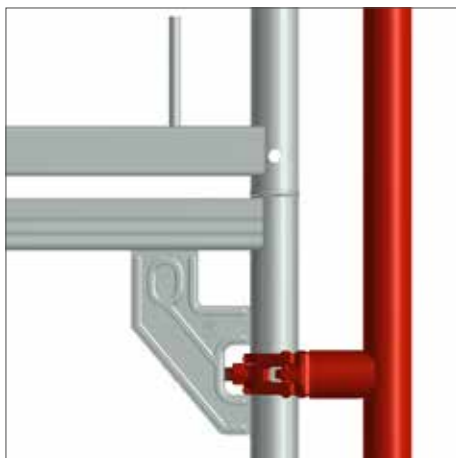

DOUBLE END GUARD RAIL 

- Steel tube Ø 33.7 mm or 26.9 mm, hot dip galvanized
- For double side protection at the ends



Width (m)	Weight (kg)	A/F	PU (pcs.)	Article no.	Price (€)	
0,73	3,40	19	25	000530	40,00	
1,09	3,80	19	25	000531	45,40	
0,73	3,40	22	25	006951	40,00	⌚
1,09	3,80	22	25	009676	45,40	⌚

WALL TIE



- Steel tube \varnothing 48.3 mm, hot dip galvanized
- Installation as short wall tie with one standard coupler
- Installation as long wall tie with two standard couplers

Length (m)	Weight (kg)	Article no.	Price (€)
0,30	1,40	000240	13,00
0,40	1,80	000242	14,40
0,50	2,00	000125	15,10
0,60	2,60	000241	16,40
0,80	3,20	000129	18,40
1,00	3,80	000127	20,40
1,30	4,80	000131	21,40
1,50	5,50	000132	24,70



WALL TIE



- Steel tube \varnothing 48.3 mm, hot dip galvanized
- Hook is welded at the inside
- Enables close to the façade in conjunction with anchor bridge WDVSconnection of scaffold couplers



Length (m)	Weight (kg)	Article no.	Price (€)
0,18	0,95	009190	15,30



WALL TIE WITH PLATE 

- Steel tube Ø 48.3 mm, hot dip galvanized
- Installation with a standard coupler



Length (m)	Weight (kg)	Article no.	Price (€)
0,70	2,70	000124	23,30



ANCHOR BRIDGE THERMAL INSULATION COMPOSITE SYSTEM 

- Set with WDVS bridge and two eye bolts
- For the anchoring of scaffolding to house walls, especially for WDVS when construction in standard version
- Even with a lever arm of 28 cm a sufficient load-bearing capacity is guaranteed in the construction in a standard version parallel to the house wall
- WDVS = Thermal insulation composite system



Weight (kg)	Article no.	Price (€)
3,61	009141	84,60

EYE BOLT Ø 12 MM



- Galvanized and welded
- For use with plastic expansion plugs 70/100 mm and plastic caps natural / black

Length (m)	Thread Length (mm)	Weight (kg)	PU (pcs.)	Article no.	Price (€)
90	54	0,155	150	000358	1,50
120	65	0,175	150	000359	1,70
160	58	0,210	100	000360	1,90
190	65	0,235	100	000363	2,10
230	65	0,265	100	000361	2,20
300	65	0,300	50	002374	2,50
350	65	0,364	50	000362	2,70
400	65	0,424	50	006333	6,00
450	65	0,468	50	007555	6,20
500	65	0,530	50	002983	7,50



EYE BOLT M12



- Galvanized and welded
- With metric thread

Length (m)	Thread Length (mm)	Weight (kg)	PU (pcs.)	Article no.	Price (€)
60	35	0,140	150	012379	5,00
80	35	0,150	150	012383	5,10
100	35	0,160	100	012384	5,20
120	35	0,175	100	012385	5,40
160	35	0,210	100	012386	5,60
220	35	0,260	50	012387	5,90



PLASTIC CAP



- For closing anchor drill holes

Colour	Weight (kg)	PU (pcs.)	Article no.	Price (€)
natural	0,003	100	000651	0,20
black	0,003	100	010353	0,20



EXPANSION PLUG



- For eye bolts with a timber thread Ø 12 mm
- For drilling Ø 14 mm

Length (m)	Weight (kg)	PU (pcs.)	Article no.	Price (€)
0,07	0,007	100	000357	0,40
0,10	0,007	100	011158	0,40



MJ-SCAFFY



- Screw-in aid for eye bolts
- With socket A/F 22 (for standard ratchet wrenches)
- With 3/4 inch square socket
- With SDS drill adapter



Weight (kg)	Article no.	Price (€)
0,374	012600	70,60

BRACKET WITH TUBE CONNECTOR 0.36 M



- Steel, hot dip galvanized
- With half coupler
- With tube connector
- With integrated deck retainer

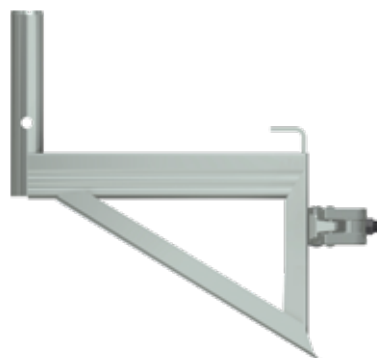

Width (m)	Weight (kg)	A/F	PU (pcs.)	Article no.	Price (€)
0,36	3,70	19	100	000582	40,60
0,36	3,70	22	100	006945	40,60



BRACKET WITHOUT TUBE CONNECTOR 0.36 M



- Steel, hot dip galvanized
- With half coupler
- With integrated deck retainer

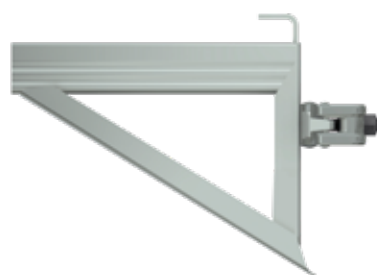

Width (m)	Weight (kg)	A/F	PU (pcs.)	Article no.	Price (€)
0,36	3,50	19	100	007485	40,60
0,36	3,50	22	100	000584	40,60



BRACKET WITHOUT TUBE CONNECTOR 0.22 M



- Steel, hot dip galvanized
- With half coupler
- Without tube connector
- With integrated deck retainer



Width (m)	Weight (kg)	A/F	PU (pcs.)	Article no.	Price (€)
0,22	2,50	19	200	006949	36,60
0,22	2,50	22	200	005839	36,60



BRACKET WITHOUT TUBE CONNECTOR 0.73 M



- Steel, hot dip galvanized
- With half coupler
- Without tube connector
- With integrated lift-off protection

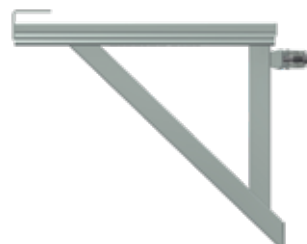

Width (m)	Weight (kg)	A/F	PU (pcs.)	Article no.	Price (€)
0,73	5,90	19	20	000592	52,90

BRACKET WITH TUBE CONNECTOR 0.73 M



- Steel, hot dip galvanized
- With half coupler
- With tube connector
- Assembly only with support (e. g. cross diagonal, see page 25)



Width (m)	Weight (kg)	A/F	PU (pcs.)	Article no.	Price (€)
0,73	6,20	19	20	000585	53,80
0,73	6,10	22	20	006946	53,80



BRACKET 0.73 M REINFORCED



- Steel, hot dip galvanized
- With half coupler
- With tube connector
- With integrated lift-off protection
- For use up to load class 3 without bracing



Width (m)	Weight (kg)	A/F	PU (pcs.)	Article no.	Price (€)
0,73	9,30	19	20	009068	91,50

FRAME BRACKET 0.73 M



- Steel, hot dip galvanized
- With two half couplers
- With two tube connectors
- For scaffolding extension and for the construction of a gap-free roof guard
- For the creation of scaffold projections or for the construction of a gap-free roof guard



Width (m)	Weight (kg)	A/F	PU (pcs.)	Article no.	Price (€)
0,73	10,00	19	20	000589	98,60

BRACKET 1.09 M



- Steel, hot dip galvanized
- With half coupler
- With tube connector
- Assembly only with support (e. g. cross diagonal, see page 25)



Width (m)	Weight (kg)	A/F	PU (pcs.)	Article no.	Price (€)
1,09	9,00	19	20	000586	121,70
1,09	9,00	22	20	006947	121,70



YOU WILL FIND BRACKETS ASPIRATIONS ON PAGE 16

CORNER BRACKET WITHOUT TUBE CONNECTOR



- Steel, hot dip galvanized
- With integrated deck retainer
- A welded on half coupler at a staggered height enables two brackets to be connected to one stand pipe



Width (m)	Weight (kg)	A/F	PU (pcs.)	Article no.	Price (€)
0,36	4,70	19	100	008087	51,70

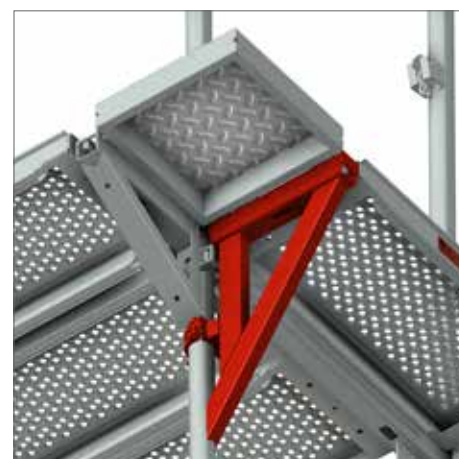
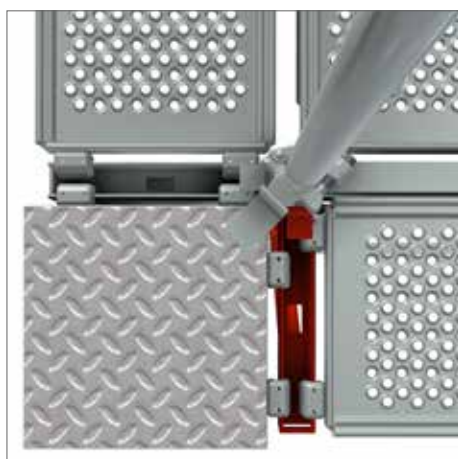

ECKBELAG



- Steel, hot dip galvanized
- As an addition to system decks in the inner corner area
- Non-slip deck
- In conjunction with corner bracket, see above

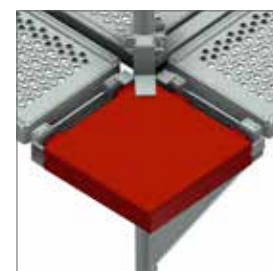
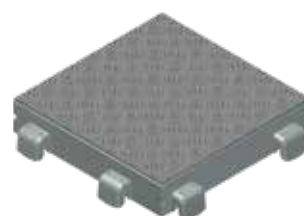

Length (m)	Width (m)	Weight (kg)	Article no.	Price (€)
0,36	0,36	7,00	008158	133,00

SYSTEM GRID BRACKET WITH TUBE CONNECTOR 0.50 M



- Steel, hot dip galvanized
- With half coupler
- With tube connector
- Used mainly to extend or shorten scaffold fields by 0.50 m
- When used as a scaffold widening, two 0.61 m platforms can be installed without gaps (see picture)

Width (m)	Weight (kg)	A/F	PU (pcs.)	Article no.	Price (€)
0,50	5,40	19	20	007126	53,10

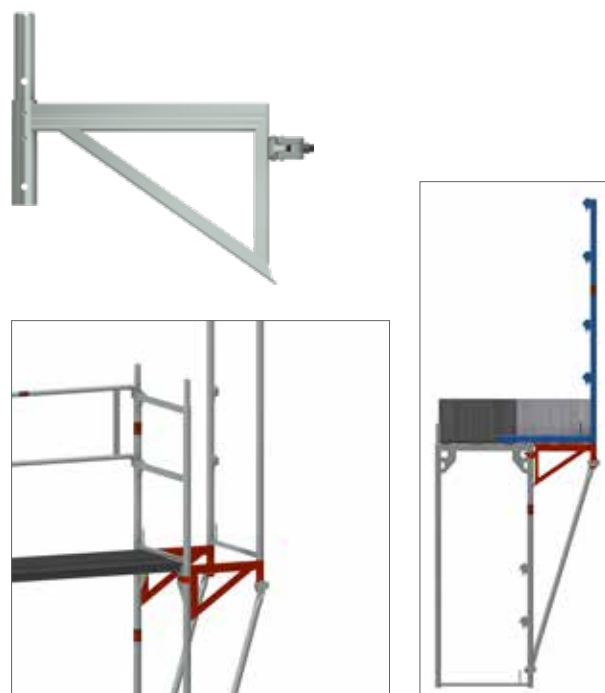

ROOF GUARD EXTENSION



- Steel tube \varnothing 48.3 mm, hot dip galvanized
- Use in connection with a frame bracket 0.73 m

Width (m)	Weight (kg)	Article no.	Price (€)
0,73	4,00	000518	40,20



DECK FASTENING



- Steel, hot dip galvanized
- Suitable for roof guard extensions

Model	Weight (kg)	Article no.	Price (€)
2-board	2,00	000590	52,90



ALUMINUM STAIRS WITH PLATFORM



- Bay height 2.00 m
- Scaffold stairway for the planned construction with facade scaffolding
- For quick and safe mounting of the scaffold levels
- The steps are designed in a non-slip manner and allow comfortable outside access for extensive use of scaffold and when transporting bulky material, without reducing the work surface in the main walkway
- Evenly distributed area load $p = 2.5 \text{ kN/m}^2$
- Single load distributed on $0.2 \times 0.2 \text{ m}^2 F = 1.5 \text{ kN}$
- Meets the requirements according to DIN EN 12811-1



Field length (m)	Length (m)	Width (m)	Weight (kg)	PU (pcs.)	Article no.	Price (€)
2,57	3,25	0,64	23,00	10	000419	524,60
3,07	3,65	0,64	28,00	10	000420	639,60

Individual customer identification possible.



OUTSIDE STAIRCASE HANDRAIL



- Steel, hot dip galvanized
- For aluminum platform stairs
- To hang in guard rail box

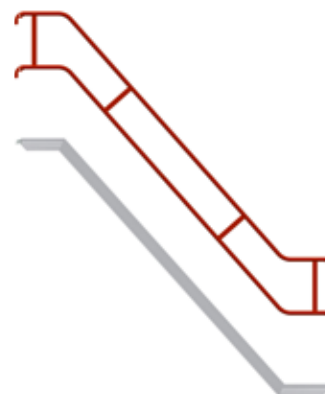

Field (m)	Length (m)	Weight (kg)	PU (pcs.)	Article no.	Price (€)
2,57	3,25	16,00	40	003182	140,00
3,07	3,65	16,50	40	003181	146,80

ROUND INSIDE GUARD RAIL



- Steel, hot dip galvanized
- For aluminum platform stairs
- For mounting to the stair string

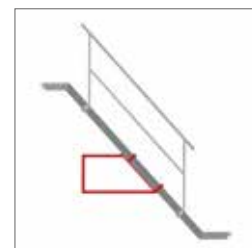

Weight (kg)	A/F	PU (pcs.)	Article no.	Price (€)
5,80	40	19	009226	69,60

INSIDE STAIRCASE HANDRAIL



- Steel, hot dip galvanized
- For aluminum platform stairs
- Can be used for field wide 2.50 and 3.00 m
- For mounting to the stair string
- Integrated end plug on the handrail for protection



Length (m)	Weight (kg)	A/F	PU (pcs.)	Article no.	Price (€)
2,25	11,50	19	20	000425	137,80
2,25	11,50	22	20	006942	137,80

GAP COVER WITH HALF COUPLER



- Steel, hot dip galvanized
- Non-slip deck
- Varied use for bridging gaps up to 0.25 m wide
- Quick assembly due to half coupler



Length (m)	Width (m)	Weight (kg)	PU (pcs.)	Article no.	Price (€)
0,35	0,38	4,00	50	007794	45,80
0,60	0,38	6,20	50	008256	71,60

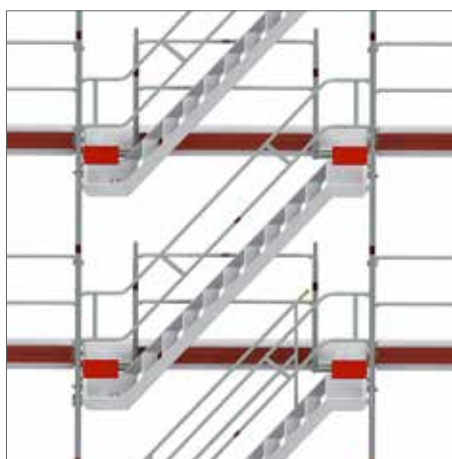

GUARD RAIL BRACKET FOR PLATFORM STAIRS



- Steel, hot dip galvanized
- With tube connector
- With welded half coupler
- Reduces the guard rail width by 0.50 m, e. g. from 2.57 to 2.07 m to make the passage to the stairs

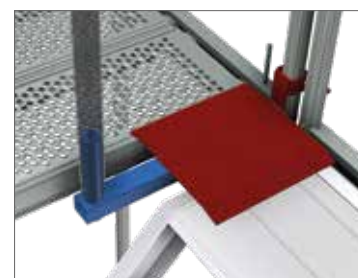

Length (m)	Weight (kg)	A/F	Article no.	Price (€)
0,50	3,20	19	008227	49,20

STEP ACCESS PLATFORM BRACKET



- Steel, hot dip galvanized
- Non-slip deck
- With two tube connectors, axial dimension 175 mm
- With two welded couplers
- To set up a stairway in front of a scaffold field
- Reduces the guard rail width by 0.50 m, e.g. from 2.57 to 2.07 m to create the passage to the stairs



A/F	Weight (kg)	PU (pcs.)	Article no.	Price (€)
22	7,50	14	000234	91,80

ALUMINUM BEGINNING STAIRS WITH PLATFORM



- Beginning stair with integrated base jack mounts
- Scaffold stairway for the planned construction with facade scaffolding
- For quick and safe mounting of the scaffold levels
- Non-slip and slip resistant steps allow comfortable ascent



Height (m)	Length (m)	Width (m)	Weight (kg)	PU (pcs.)	Article no.	Price (€)
1,00	1,49	0,64	11,60	10	006521	340,70
1,50	1,75	0,64	18,56	15	009945	487,40

STAIR GUARD RAIL



- Steel, hot dip galvanized
- For aluminum beginning stairs with platform 1.00 m
- To hang in rail housings



Weight (kg)	PU (pcs.)	Article no.	Price (€)
6,70	40	009179	135,70

ACCESS LADDER 1.00 M



- Steel, hot dip galvanized
- System-related suspension
- Enables easy entry into the scaffold, with a field height of 1.00 m



Length (m)	Width (m)	Weight (kg)	Article no.	Price (€)
1,00	0,62/0,47	7,90	010407	93,80

LEDGER



- Steel, hot dip galvanized
- U-profile with welded half couplers
- For mounting decks in any intermediate levels

Width (m)	Weight (kg)	Article no.	Price (€)
0,73	3,60	000594	55,20
1,09	6,50	000593	61,50

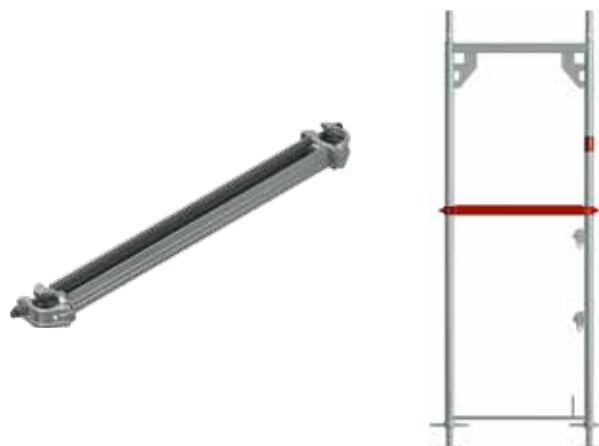

DECK TRANSOM



- Steel, hot dip galvanized
- For installation between two assembly frames to create a continuous deck area

Width (m)	Weight (kg)	Article no.	Price (€)
0,73	4,70	004072	67,30
1,09	6,40	002556	74,30



DECK FASTENING



- Steel, hot dip galvanized
- For brackets

Width (m)	Weight (kg)	Article no.	Price (€)
0,32	1,00	000580	14,80
0,50	1,20	007745	16,20
0,73	1,50	000581	18,30
1,09	2,00	000579	23,20



DECK FASTENING WITH HALF COUPLER



- Steel, hot dip galvanized
- With welded half coupler
- For securing decks against lifting off

Weight (kg)	A/F	Article no.	Price (€)
1,10	19	008156	15,80
1,15	22	008157	15,80

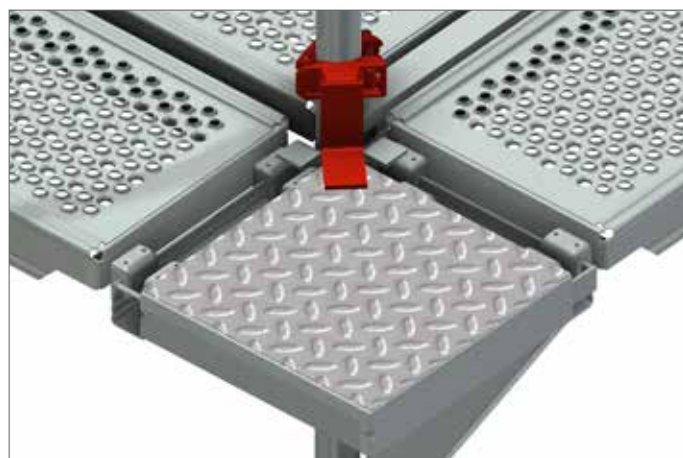
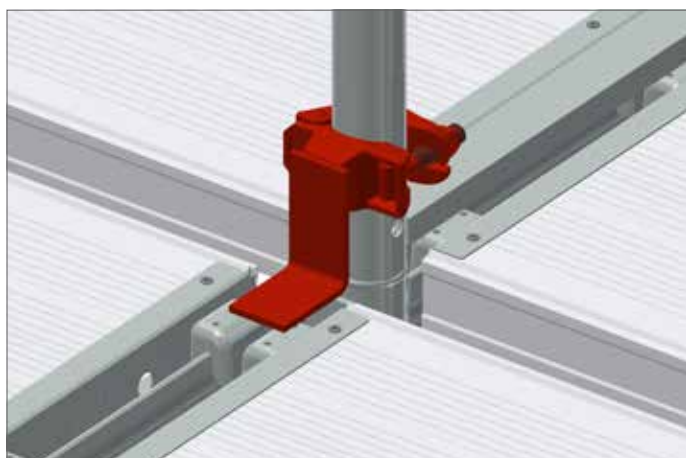

DECK FASTENING WITH WEDGE



- Steel, hot dip galvanized
- With wedge head connection
- For securing decks against lifting off



Weight (kg)	Article no.	Price (€)
0,70	006850	14,60

DECK FASTENING



- Steel, hot dip galvanized
- For preventing decks from lifting off



Width (m)	Weight (kg)	A/F	Article no.	Price (€)
0,40	1,50	19	007302	26,60

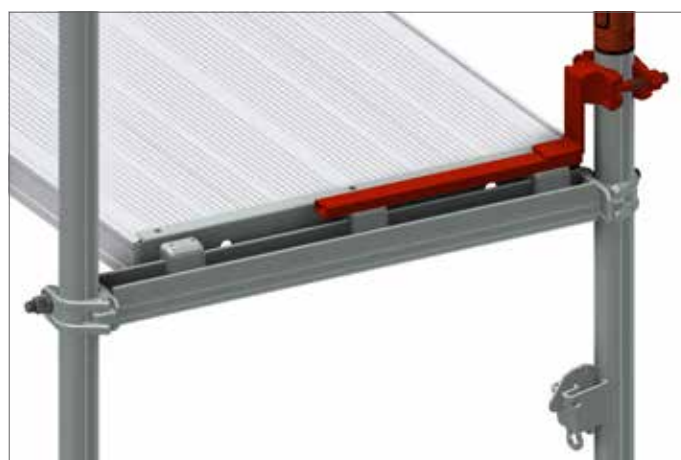

GAP COVER 

- Steel, hot dip galvanized
- Non-slip deck
- Used to cover gaps in corner scaffolding
- System-related suspension

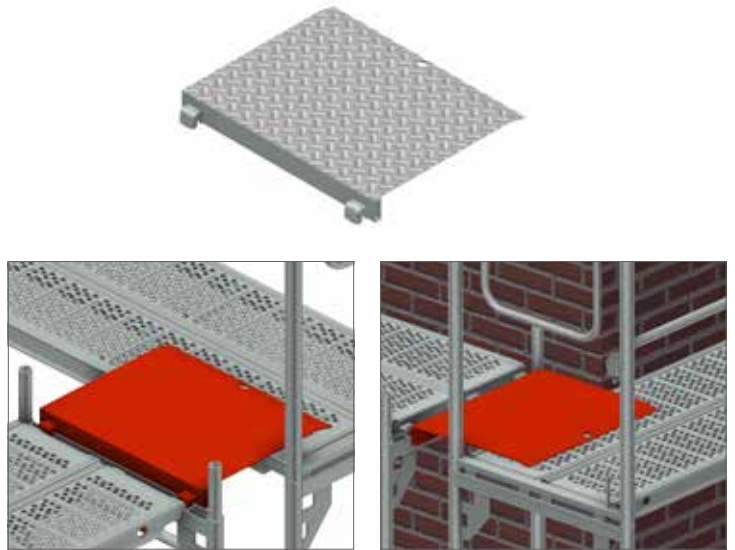

Model	Width (m)	Weight (kg)	PU (pcs.)	Article no.	Price (€)
1-board	0,32	5,00	50	009503	58,60
2-board	0,63	9,20	50	008374	83,20

POLYGON COVERAGE 

- Steel, hot dip galvanized
- Non-slip deck with deck fastening for gap-free construction of round scaffolding from 0 to 45°
- System-related suspension



Model	Width (m)	Weight (kg)	PU (pcs.)	Article no.	Price (€)
2-board	0,61	8,50	50	007731	70,30
3-board	0,94	20,50	50	014230	226,40



**FURTHER GAP COVERS CAN BE FOUND
IN OUR PRICE LIST „ACCESSORIES“.**

END GUARD RAIL 1-BOARD



- Steel tube, hot dip galvanized
- For double side protection at the ends
- Plugged into each other
- Can be used for side protection on round scaffoldings



Weight (kg)	PU (pcs.)	A/F	Article no.	Price (€)
2,60	19	50	009366	29,20

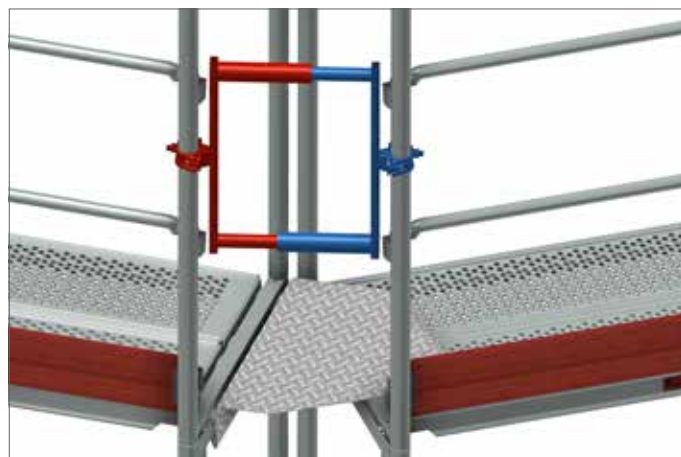
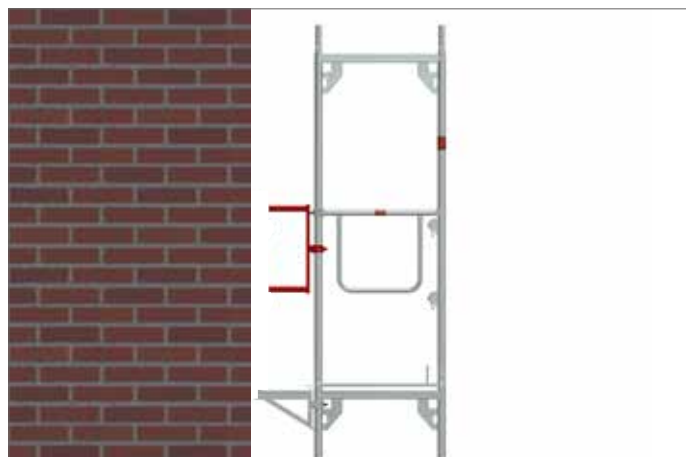

ROOFER BRACKET



- Steel, hot dip galvanized
- With two Tube connectors
- Meets different requirements for ergonomic workplaces for painters and tinsmiths
- For use up to load class 3

Width (m)	Weight (kg)	A/F	VPE	Article no.	Price (€)
0,73	15,60	19	12	000275	150,30

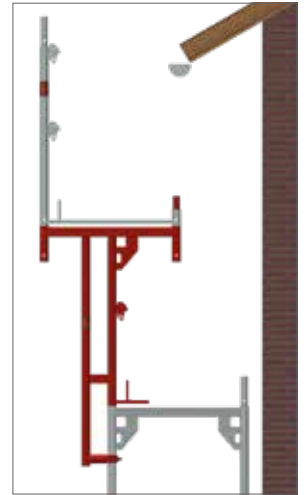
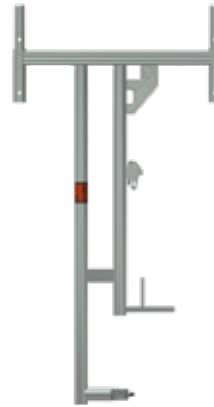

CONSOL FRAME



- Steel, hot dip galvanized
- With two tube connectors
- For use at the eaves

Height (m)	Width (m)	Weight (kg)	PU (pcs.)	Article no.	Price (€)
1,00	0,73	14,60	20	010918	133,40

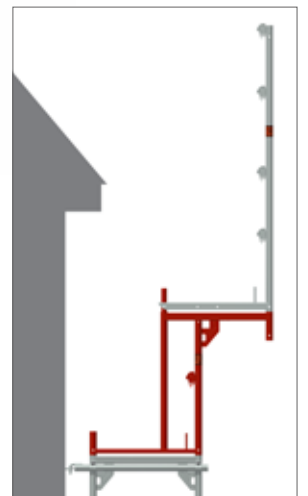
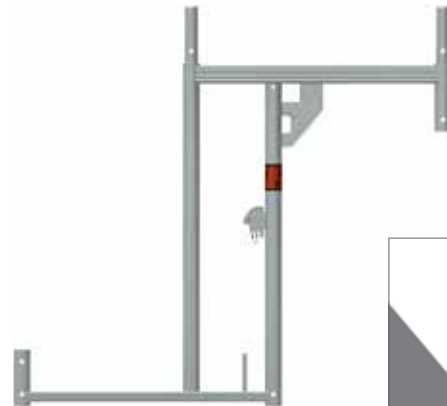

RAIN CANOPY BRACKET TWO-PIECE SET



- Steel, hot dip galvanized
- For use with frame width 0.73 m in the top scaffold platform
- In conjunction with guard rails and tarps serves this component provides weather protection



Width (m)	Weight (kg)	Article no.	Price (€)
0,73	13,50	008130	184,50



GUARD RAILS



- Steel tube Ø 38 mm, hot dip galvanized
- Compressed to the end and punched
- Time-saving attachment via the self-locking swivel pins
- No tools required for assembly

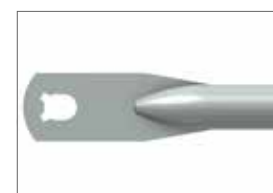

Length (m)	Weight (kg)	PU (pcs.)	Article no.	Price (€)
0,73	1,40	100	011958	18,20
1,09	2,00	100	011959	18,80
1,57	2,90	100	011963	20,00
2,07	3,80	100	011964	20,50
2,57	4,70	100	011965	21,90
3,07	5,50	100	011966	23,30

ROLLING TOWER 2.00 M 

- Steel, rectangular tube, hot dip galvanized
- With two tube connectors
- All requirements of DIN 4420-3 must be met for mobile scaffolding with a steel beam. This applies particularly to sufficient ballast, safe inside climbing via access decks with ladders and the necessary side guards at each soil level.

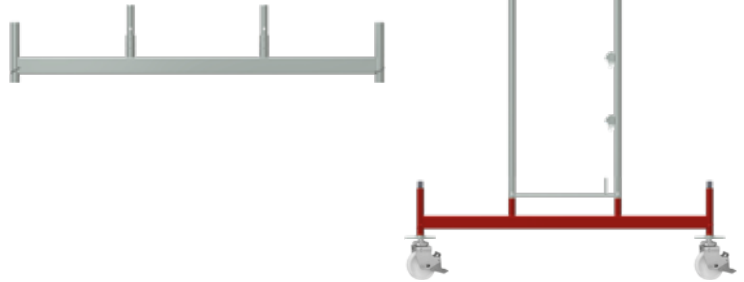

Width (m)	Weight (kg)	Article no.	Price (€)
2,00	21,00	000599	134,50

ROLLING TOWER 3.00 M 

- Steel, rectangular tube, hot dip galvanized
- With four tube connectors
- To create mobile scaffolds
- Deck transom (see page 37)

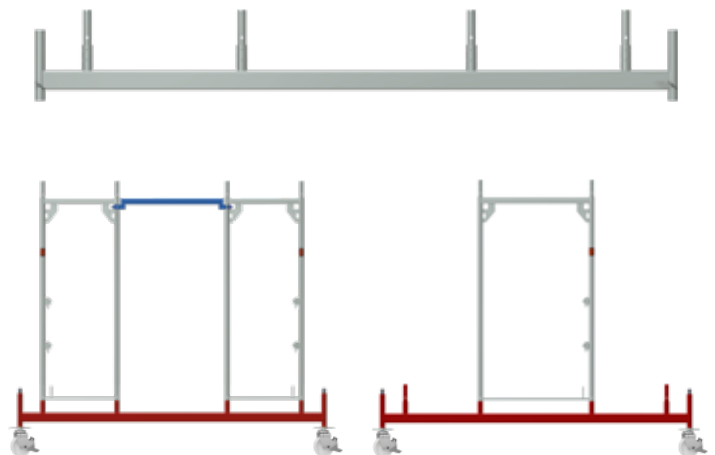

Width (m)	Weight (kg)	Article no.	Price (€)
3,00	32,00	000598	235,70

SPINDLE SECURITY



- Steel, hot dip galvanized
- With half coupler
- Secures base jacks and swivel castors with spindle when moving scaffolding units with a crane

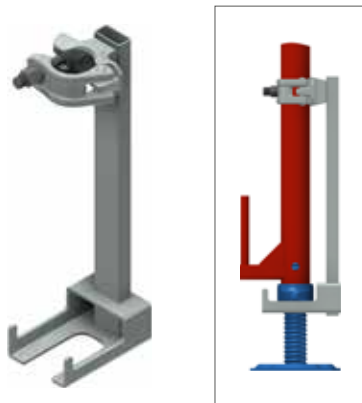

Height (m)	Weight (kg)	A/F	PU (pcs.)	Article no.	Price (€)
0,40	2,00	19	200	010294	30,20

CASTOR WITH SPINDLE



- Bearing 10 kN with central load distribution
- Castor Ø 200 mm made of polyamide with run stop
- Levelling through adjustable steel spindle
- The DIN 4420-3 applies when a rolling towers made of a scaffolding
- A standard proof of stability is required for this mobile scaffold



Weight (kg)	PU (pcs.)	Article no.	Price (€)
7,00	80	000332	102,50

ADJUSTMENT TUBE



- Steel, hot dip galvanized
- Adjustment range 10 x 0.10 m = 1.00 m
- For levelling unequal ground
- Use in connection with a decking transom and base jack

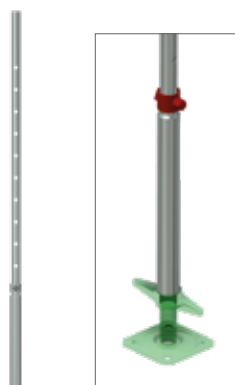

Height (m)	Weight (kg)	Article no.	Price (€)
1,70	5,80	000402	56,70

PROTECTIVE PAD FOR BASE JACK

- Plastic
- With reflector

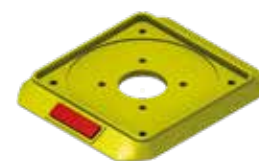

PU (pcs.)	Article no.	Price (€)
80	008110	4,40

HEAD JACK

- Steel, hot dip galvanized
- Supporting element for support and platform scaffolding as well as for formwork scaffolds
- Used to hold squares timbers, laminated beams and formwork beams



Opening dimension (mm)	Weight (kg)	PU (pcs.)	Article no.	Price (€)
148	5,60	200	000693	40,60
180	8,30	-	011537	49,90

SECURITY PIN



- Steel, hot dip galvanized
- Ø 9 mm
- For securing the scaffold joints against unintentional lift-off



Weight (kg)	PU (pcs.)	Article no.	Price (€)
0,15	100	000508	1,40

STANDARD COUPLER EN

- Steel, hot dip galvanized, drop-forged
- Robust model
- For right-angled connection of tubes of Ø 48.3 mm
- Class BB, EN 74-1
- To be used in the classes B and BB of the steel and aluminum tube



Thread	A/F	Weight (kg)	PU (pcs.)	Article no.	Price (€)
Standard	22	1,15	25	000325	8,60
Standard	19	1,15	25	000326	8,60
Quick	22	1,15	25	007521	9,30
Quick	19	1,15	25	007523	9,30

SWIVEL COUPLER EN

- Steel, hot dip galvanized, drop-forged
- Robust model
- For any angular connection of tubes of Ø 48.3 mm
- Class B, EN 74-1
- To be used in the class B of the steel and aluminum tube



Thread	A/F	Weight (kg)	PU (pcs.)	Article no.	Price (€)
Standard	22	1,35	25	000328	9,30
Standard	19	1,35	25	000329	9,30
Quick	22	1,35	25	007522	9,90
Quick	19	1,35	25	007524	9,90

SPARE PARTS CAN BE FOUND IN OUR PRICE LIST „ACCESSORIES“.

SCAFFOLD TUBE STEEL EN

- S235 Steel, hot dip galvanized
- Measurements as per EN 39
- Manufacturing length 6.00 m
- Minimum yield strength 235 N/mm²
- Connection of standard couplers allowed
- Special lengths on request



Model (mm)	Length (m)	Weight (kg)	PU (pcs.)	Article no.	Price (€)
48,3 x 3,2	1,00	3,77	61	004548	17,20
48,3 x 3,2	2,00	7,54	61	004550	31,40
48,3 x 3,2	3,00	11,31	61	004552	45,60
48,3 x 3,2	4,00	15,08	61	004554	61,80
48,3 x 3,2	5,00	18,85	61	005619	76,00
48,3 x 3,2	6,00	22,60	61	004087	85,00

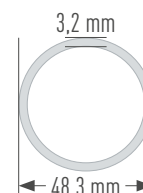

GUARD RAIL COUPLER

EN

- Steel, hot dip galvanized
- With half coupler
- For attaching additional guard rails, e. g. on the inside of the scaffold



Thread	Weight (kg)	A/F	PU (pcs.)	Article no.	Price (€)
Standard	1,20	22	25	002464	20,60
Standard	1,20	19	25	000591	20,60

GUARD RAIL COUPLER WITH WEDGE

- Steel, hot dip galvanized
- With half coupler
- Quick assembly due to wedge lock



Weight (kg)	Article no.	Price (€)
1,30	003550	21,30

DISTANCE COUPLER

- Steel tube \varnothing 48.3 mm
- With two welded couplers, galvanized
- E. g. as connection between facade scaffold and a forward-placed stair ascent

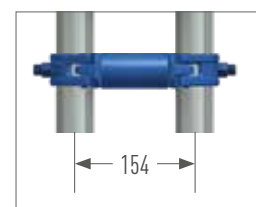

Axle dimension (m)	A/F	Weight (kg)	Article no.	Price (€)
0,110	22	1,60	008225	26,00
0,154	19	1,80	008297	26,30
0,180	22	2,00	000233	27,10

LATTICE BEAM STEEL



- Steel tube Ø 48.3 mm, hot dip galvanized
- Load depends on span according to the separate load table

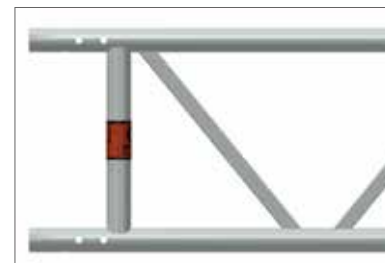

Length (m)	Height (m)	Weight (kg)	PU (pcs.)	Article no.	Price (€)
3,20	0,40	30,00	25	000108	198,50
4,20	0,40	39,00	25	000109	245,80
5,20	0,40	50,00	25	000110	297,80
6,20	0,40	58,00	25	000111	335,40
7,60	0,40	72,00	25	000112	496,30

LATTICE BEAM ALUMINUM



- Aluminum tube Ø 48.3 mm
- Load depends on span according to the separate load table



Length (m)	Height (m)	Weight (kg)	PU (pcs.)	Article no.	Price (€)
3,20	0,40	12,00	25	000255	234,00
4,20	0,40	15,00	25	000257	291,00
5,20	0,40	20,00	25	000258	348,00
6,20	0,40	23,00	25	000259	390,10
8,10	0,40	31,00	25	000261	550,00

TUBE CONNECTOR FOR LATTICE BEAMS



- Steel, hot dip galvanized
- For the continuous extensions of lattice beams



Model	Weight (kg)	Article no.	Price (€)
Straight	1,30	003588	30,50

BOLT WITH CUTTER PIN



- Screw-free connection of lattice beams
- Replaces usual screws M 12 x 60 mm there by reducing the assembly time
- Consisting of cotter pin (article no. 002232), bolt (article no. 002235) and washer (article no. 002964)
- All articles are also available separately



Weight (kg)	Article no.	Price (€)
0,09	002237	3,00

DECK LEDGER FOR LATTICE BEAMS



- Steel, hot dip galvanized
- With two tube connectors
- For use with bridging with lattice beams

Width (m)	Weight (kg)	Article no.	Price (€)
0,73	5,50	008161	80,60
1,09	9,10	010158	96,10



WALL CONNECTION FOR LATTICE BEAM



- Steel, hot dip galvanized
- For fastening to the wall, e. g. for bridging constructions
- For lattice beams with 400 mm construction height

Weight (kg)	Article no.	Price (€)
3,50	000170	78,00

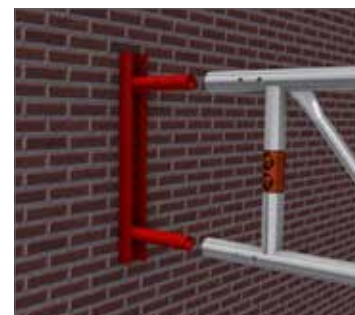

The system free safety enclosure OPTI-BOARD is the answer to many questions that you may ask yourself when planning your construction site with regard to environmental and noise protection. When renovating or building a new building, the construction site enclosure protects employees and passers by from noise, dust and dirt.

- Light cassette: The transparent version of the OPTI-BOARD enables work in daylight conditions.
- Dust-tight: A circumferential rubber seal makes the OPTI-BOARD almost dust-tight. This enables a clean construction site cladding, the use of vacuum systems (asbestos removal) and weather-independent sandblasting.
- Quick and easy assembly
- Can be use in the UNI, UNI-CONNECT, UNI TOP, COMBI and OPTIMA systems
- Can be installed vertically and horizontally

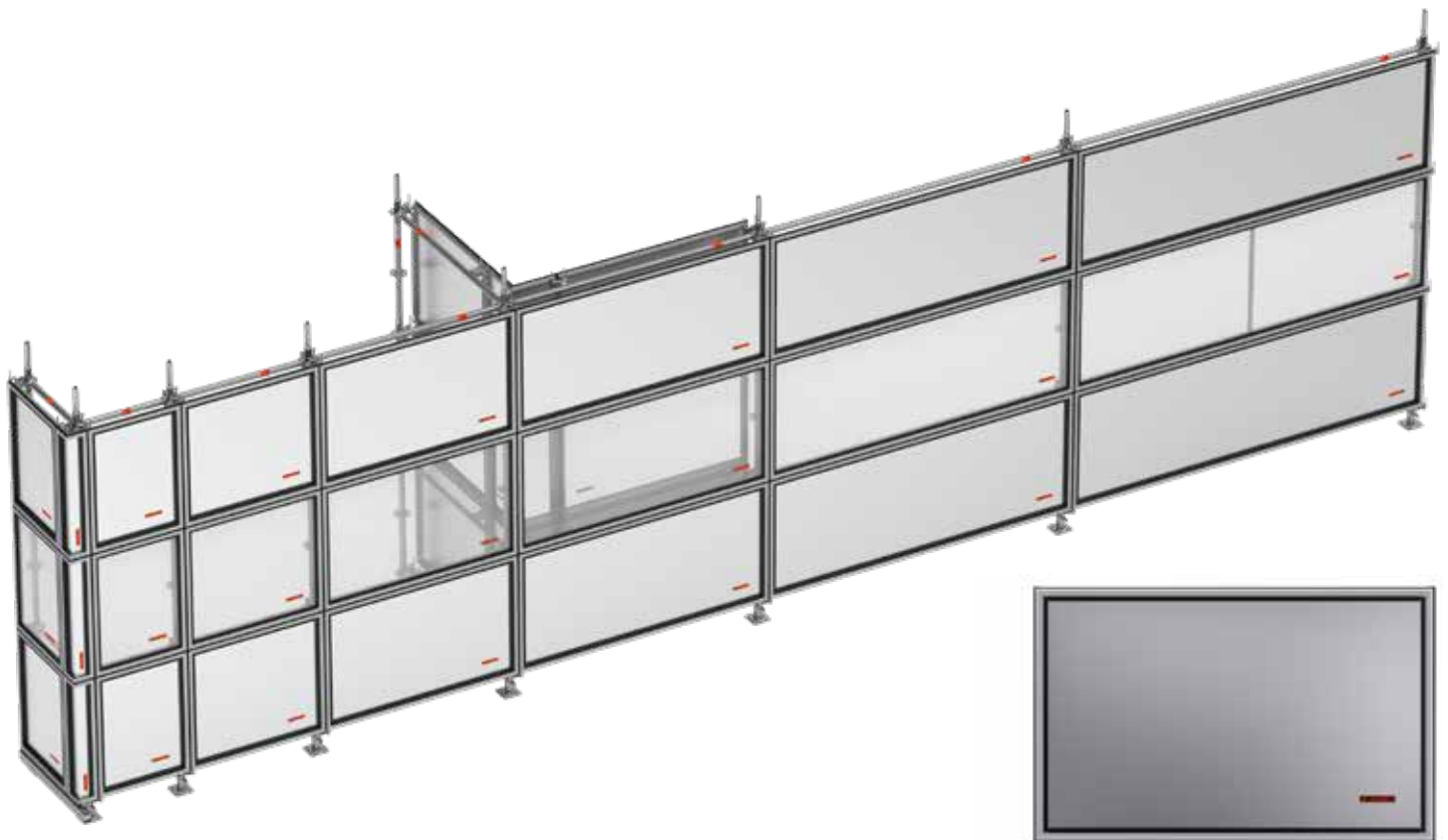

WALLCASSETTE SHEET

Width	Height	Weight (kg)	PU (St.)	Article-no.	Price (€)
0,50	1,00	5,50	14	012064	172,50
0,73	1,00	6,85	14	012076	164,20
1,00	1,00	8,70	14	012065	198,50
1,09	1,00	9,20	14	012077	188,80
1,57	1,00	12,30	14	012078	218,80
2,07	1,00	15,50	14	012079	258,80
2,57	1,00	18,70	14	012080	278,80
3,07	1,00	22,50	14	012081	337,10

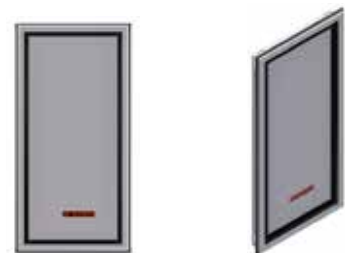

WALLCASSETTE LIGHT



Width	Height	Weight (kg)	PU (St.)	Article-no.	Price (€)
0,50	1,00	4,30	14	012070	189,70
0,73	1,00	5,30	14	012082	180,70
1,00	1,00	6,45	14	012071	224,80
1,09	1,00	6,80	14	012083	213,90
1,57	1,00	8,90	14	012084	295,60
2,07	1,00	11,00	14	012085	345,70
2,57	1,00	13,20	14	012086	406,10
3,07	1,00	15,75	14	012087	446,10

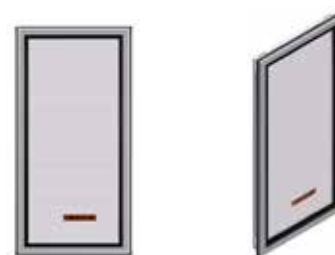

INSIDE CORNER FOR WALLCASSETTE



Width	Height	Weight (kg)
0,40	1,00	6,85

PU (St.)	Article-no.	Price (€)
20	012088	206,10



OUTSIDE CORNER FOR WALLCASSETTE



Width	Height	Weight (kg)
0,17	1,00	3,90

PU (St.)	Article-no.	Price (€)
50	012089	172,80



CASSETTE HOLDER | CORNER CASSETTE HOLDER



System	Weight (kg)	PU (St.)	Article-no.	Price (€)
TUBE	0,85	300	012062	33,40
TUBE	1,85	500	012063	58,60



STACKING PALLET FOR TUBES 

- Steel tube, hot-dip galvanized
- Specially suited for module scaffolds, e.g. tubes and toe boards
- Open all round
- Suited for stacked and crane transports
- The tube supports are removable and are to be stowed securely in the base frame so that empty pallets can be transported and stacked
- Special designs on request
- Push-on tube with bevel on one side, also available separately (Article no. 005791)



Length (m)	Width (m)	Weight (kg)	PU (pcs.)	Article no.	Price (€)
0,85	0,85	30,50	5	006962	232,20
1,25	0,55	31,80	5	010334	231,90
1,25	0,85	35,00	5	005614	240,20

SCAFFOLD PALLET FOR ASSEMBLY FRAME 

- Steel tube, hot dip galvanized
- Continuous fork mount for safe fork-lift transport
- Additional cut-outs allow side retracting
- Capacity: 20 Assembly frames

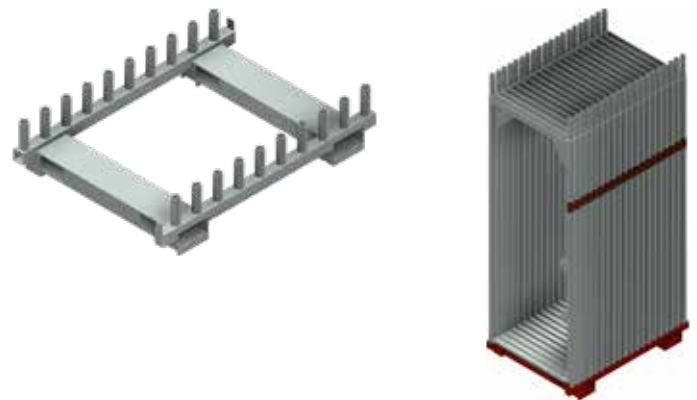

System	Length (m)	Width (m)	Weight (kg)	PU (pcs.)	Article no.	Price (€)
UC 70	1,11	0,79	31,10	5	008317	301,90
UC 100	1,11	1,16	38,70	5	008367	328,10

OTHER PRODUCTS FOR STORAGE AND TRANSPORT FIND IN OUR PRICE LIST 'ACCESSORIES'

ASSEMBLY SECURITY GUARD RAIL

The assembly security guard rail (MSG) serves as a security measure on the top scaffold and in the ascent field. The system consisting of guard rail posts and extendable guard rail spar is mounted in the construction of the scaffold before entering the top scaffold position of the underlying layer.

- Approved by the German Institute for Building Supervision DIBt under the number: Z-8.22-1002.

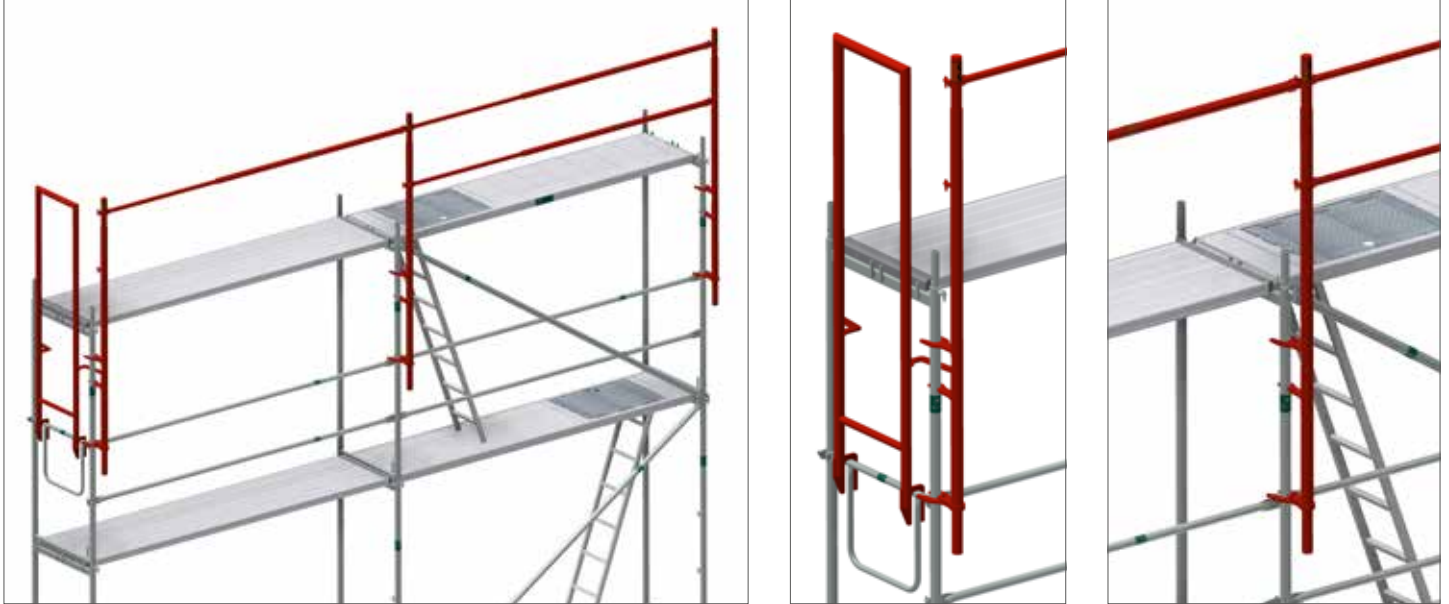

POST FOR ASSEMBLY SECURITY GUARD RAIL



- Coaxially arranged aluminum tubes with two swivel pin connections
- Fits any scaffold tube \varnothing 48.3 mm
- Maximum flexibility in the application
- Tool-free fixation through anti-rotation device
- Operation (locking and unlocking) from above and below
- At the same time assembly and disassembly of guard rail and intermediate beam

Weight (kg)	PU (pcs.)	Article no.	Price (€)
5,80	45	011088	251,50



GUARD RAIL FOR ASSEMBLY SECURITY GUARD RAIL



- Aluminum tube
- Two-sided recesses for attachment to the guard rail post
- Locking pin prevents the unintentional sliding apart of the tubes during transport
- Piston guide belts for smooth sliding of the aluminum tubes



For field length	Weight (kg)	PU (pcs.)	Article no.	Price (€)
1,50 - 1,57 m	3,40	10	011437	133,40
2,00 - 3,07 m	4,60	10	011156	143,90



FRONT ASSEMBLY SECURITY GUARD RAIL



- Ergonomic, easy to handle and economical to install
- One-piece component as system-free design, no moving parts
- Tool-free installation
- Integrated deadlock
- For easy installation, users stand on the covered position
- Comfortable implementation from below and above

Weight (kg)	PU (pcs.)	Article no.	Price (€)
7,10	10	011131	282,80



SET - PERSONAL PROTECTIVE EQUIPMENT MILLER 1

EN N



- Revolution R2 Comfort harness – with 80 cm back eyelet extension (EN 361), elastic dura flex belt band, sharp edge tested, front and rear eyelet, comfort back pads, automatic fasteners for quick on and off, belt end clips, swivel connection at waist height for optimal ergonomics when bending or stretching, attachment point for tools and accessories, integrated label tray
- Lifetime of the material is 10 years
- Lanyards with shock absorber - length 2.00 m, sharp edges tested, horizontally approved (attachment point on floor level), 63 mm scaffold hook, stretchy design for more latitude of movement, safety clip for fastening to harness, Teflon-coated for longer life, EN 354 and EN 355
- Equipment bag - 0.27 x 0.80 m (D x H), made of PVC, red



Size	Article no.	Price (€)
S - M	006273	280,00
L - XL	005610	280,00

SET - PERSONAL PROTECTIVE EQUIPMENT MILLER 2

EN N



- Revolution R2 Comfort harness – with 80 cm back eyelet extension (EN 361), elastic dura flex belt band, sharp edge tested, front and rear eyelet, comfort back pads, automatic fasteners for quick on and off, belt end clips, swivel connection at waist height for optimal ergonomics when bending or stretching, attachment point for tools and accessories, integrated label tray
- Twin Manyard EDGE 2.00 m - with 2 x 63 mm aluminum hooks (EN 354 + 355), sharp edges tested, integrated shock absorber with fall of indicator
- Lifetime of the material is 10 years
- Equipment bag - 0.27 x 0.80 m (D x H), made of PVC, red



Size	Article no.	Price (€)
L - XL	011284	410,00

ALL SET COMPONENTS MAY ALSO BE ORDERED SEPARATELY

KASK INDUSTRIAL CLIMBING HELMET PLASMA Q

EN ID N

- Tested and approved according to EN 397
- With chin strap
- Adjusting wheels allow one quick and easy adjustment to the right size
- With ring for attaching the helmet to a belt

Color	Article no.	Price (€)
blue	010496	74,60
white	010497	74,60
yellow	010498	74,60
orange	010499	74,60
red	010500	74,60
green	010501	74,60
dark green	010502	74,60
royal blue	010503	74,60
black	010453	74,60



KASK INDUSTRIAL CLIMBING HELMET ZENITH

EN ID N

- Tested and approved according to EN 397 and EN 50365
- Various settings allow a quick and easy adjust
- With ring for attaching the helmet to a belt

Color	Article no.	Price (€)
blue	010504	84,70
white	010505	84,70
yellow	010506	84,70
orange	010507	84,70
red	010508	84,70
green	010509	84,70
black	010510	84,70



OTHER PROTECTIVE EQUIPMENT FIND IN OUR PRICELIST 'ACCESSORIES'

SCAFFOLD BAY LENGTH 3.07 X 0.73 M				Length x Height (m)		
				100.00 x 10.20	50.00 x 10.20	10.00 x 10.20
				1,002 m ² - 32 Fields	501 m ² - 16 Fields	94 m ² - 3 Fields
Product description	Dimension (m)	Article no.	Price (€)	Pieces	Pieces	Pieces

BASE EQUIPMENT						
Assembly frame steel 70	2.00 x 0.73	000853	88,80	132	68	16
Steel deck OPTI-LINE 0.32 m	3.07 x 0.32	008775	102,60	250	122	18
Access deck plywood panel	3.07 x 0.61	000494	409,50	4	4	4
Diagonale	3.07	000553	45,60	28	16	4
Start ledger	0.73	000595	40,00	2	2	2
Back guard rail	3.07	000504	24,60	256	128	24
Toe board	3.07	000542	25,10	128	64	12
End toe board	0.73	000544	15,00	8	8	8
Double end guard rail	0.73	000530	40,00	6	6	6
Guard rail post	1.00 x 0.73	000867	51,10	31	15	2
Top end guard rail post	1.00 x 0.73	000865	91,60	2	2	2
Base jack	0.60	000320	22,00	66	34	8
Horizontal brace	3.07	000551	90,70	6	3	0
Wall tie	0.60	000241	16,40	35	19	6
Standard coupler	A/F 19	000326	8,60	35	19	6
Expansion plug	0.07	000357	0,40	35	19	6
Eye bolt	0.12	000359	1,70	35	19	6
Total price in €				54.948,80	28.603,10	7.043,60

EXTRA CHARGE IN EXCHANGE				1,002 m ² - 32 Fields		501 m ² - 16 Fields		94 m ² - 3 Fields	
FROM	AGAINST	Article no.	List price (€)	Pieces	Extra charge (€)	Pieces	Extra charge (€)	Pieces	Extra charge (€)
Access deck with plywood deck	Access deck with aluminum deck	000488	473,00	4	254,00	4	254,00	4	254,00
Steel deck OPTI-LINE 0.32 m	Combi acces deck with plywood panel	000484	226,00	125	2.600,00	61	1.268,80	9	187,20
Steel deck OPTI-LINE 0.32 m	Aluminum deck with steel caps	006634	284,50	125	9.912,50	61	4.837,30	9	713,70
Assembly frame steel 70	Assembly frame aluminum 70	000863	136,30	132	6.270,00	68	3.230,00	16	760,00
Access decks	Platform stair tower*	-	-	1	2.783,80	1	2.783,80	1	2.783,80

*The scaffold components required for the platform stair tower are summarized in a price and offset against the access decks.

SCAFFOLD BAY LENGTH 2.57 X 0.73 M				Length x Height (m)		
				100.00 x 10.20	50.00 x 10.20	10.00 x 10.20
				1,049 m ² - 40 Fields	525 m ² - 20 Fields	105 m ² - 4 Fields
Product description	Dimension (m)	Article no.	Price (€)	Pieces	Pieces	Pieces

BASE EQUIPMENT						
Assembly frame steel 70	2,00 x 0,73	000853	88,80	164	84	20
Steel deck OPTI-LINE 0.32 m	2,57 x 0,32	008774	90,30	314	154	26
Access deck plywood panel	2,57 x 0,61	000492	359,10	4	4	4
Diagonale	2,57	000552	42,80	32	16	4
Start ledger	0,73	000595	40,00	2	2	2
Back guard rail	2,57	000503	23,10	320	160	32
Toe board	2,57	000541	23,10	160	80	16
End toe board	0,73	000544	15,00	8	8	8
Double end guard rail	0,73	000530	40,00	6	6	6
Guard rail post	1,00 x 0,73	000867	51,10	39	19	3
Top end guard rail post	1,00 x 0,73	000865	91,60	2	2	2
Base jack	0,60	000320	22,00	82	42	10
Horizontal brace	2,57	000550	77,00	7	3	0
Wall tie	0,60	000241	16,40	43	23	7
Standard coupler	SW 19	000326	8,60	43	23	7
Expansion plug	0,07	000357	0,40	43	23	7
Eye bolt	0,12	000359	1,70	43	23	7
Toatal price in €				62.935,80	32.403,00	8.026,40

EXTRA CHARGE IN EXCHANGE				1,049 m ² - 40 Fields		525 m ² - 20 Fields		105 m ² - 4 Fields	
FROM	AGAINST	Article no.	List price (€)	Pieces	Extra charge (€)	Pieces	Extra charge (€)	Pieces	Extra charge (€)
Access deck with plywood deck	Access deck with aluminum deck	000486	423,80	4	258,80	4	258,80	4	258,80
Steel deck OPTI-LINE 0.32 m	Combi acces deck with plywood panel	000483	191,10	157	1.648,50	77	808,50	13	136,50
Steel deck OPTI-LINE 0.32 m	Aluminum deck with steel caps	006633	250,40	157	10.958,60	77	5.374,60	13	907,40
Assembly frame steel 70	Assembly frame aluminum 70	000863	136,30	164	7.790,00	84	3.990,00	20	950,00
Access decks	Platform stair tower*	-	-	1	2.557,90	1	2.557,90	1	2.557,90

*The scaffold components required for the platform stair tower are summarized in a price and offset against the access decks.

SCAFFOLD BAY LENGTH 2.57 X 1.09 M				Length x Height (m)		
				100.00 x 10.20	50.00 x 10.20	10.00 x 10.20
				1,049 m ² - 40 Fields	525 m ² - 20 Fields	105 m ² - 4 Fields
Product description	Dimension (m)	Article no.	Price (€)	Pieces	Pieces	Pieces

BASE EQUIPMENT						
Assembly frame steel 100	2.00 x 1.09	000858	111,80	164	84	20
Steel deck OPTI-LINE 0.32 m	2.57 x 0.32	008774	90,30	475	235	43
Access deck plywood panel	2.57 x 0.61	000492	359,10	4	4	4
Diagonale	2.57	000552	42,80	32	16	4
Start ledger	1.09	009148	49,20	2	2	2
Back guard rail	2.57	000503	23,10	320	160	32
Toe board	2.57	000541	23,10	160	80	16
End toe board	1.09	000545	17,20	8	8	8
Double end guard rail	1.09	000531	45,40	6	6	6
Guard rail post	1.00 x 1.09	000869	53,40	39	19	3
Top end guard rail post	1.00 x 1.09	000556	103,00	2	2	2
Base jack	0.60	000320	22,00	82	42	10
Horizontal brace	2.57	000550	77,00	7	3	0
Wall tie	0.60	000241	16,40	43	23	7
Standard coupler	A/F 19	000326	8,60	43	23	7
Expansion plug	0.07	000357	0,40	43	23	7
Eye bolt	0.12	000359	1,70	43	23	7
Total price in €				81.427,00	41.784,20	10.119,60

EXTRA CHARGE IN EXCHANGE				1.049 m ² - 40 Fields		525 m ² - 20 Fields		105 m ² - 4 Fields	
FROM	AGAINST	Article no.	List price (€)	Pieces	Extra charge (€)	Pieces	Extra charge (€)	Pieces	Extra charge (€)
Access deck with plywood deck	Access deck with aluminum deck	000486	423,80	4	258,80	4	258,80	4	220,00
Steel deck OPTI-LINE 0.32 m	Aluminum deck with steel caps	006633	250,40	157	10.958,60	77	5.374,60	13	813,80
Access decks	Platform stair tower*	-	-	1	2.557,90	1	2.557,90	1	2.557,90

*The scaffold components required for the platform stair tower are summarized in a price and offset against the list decks.

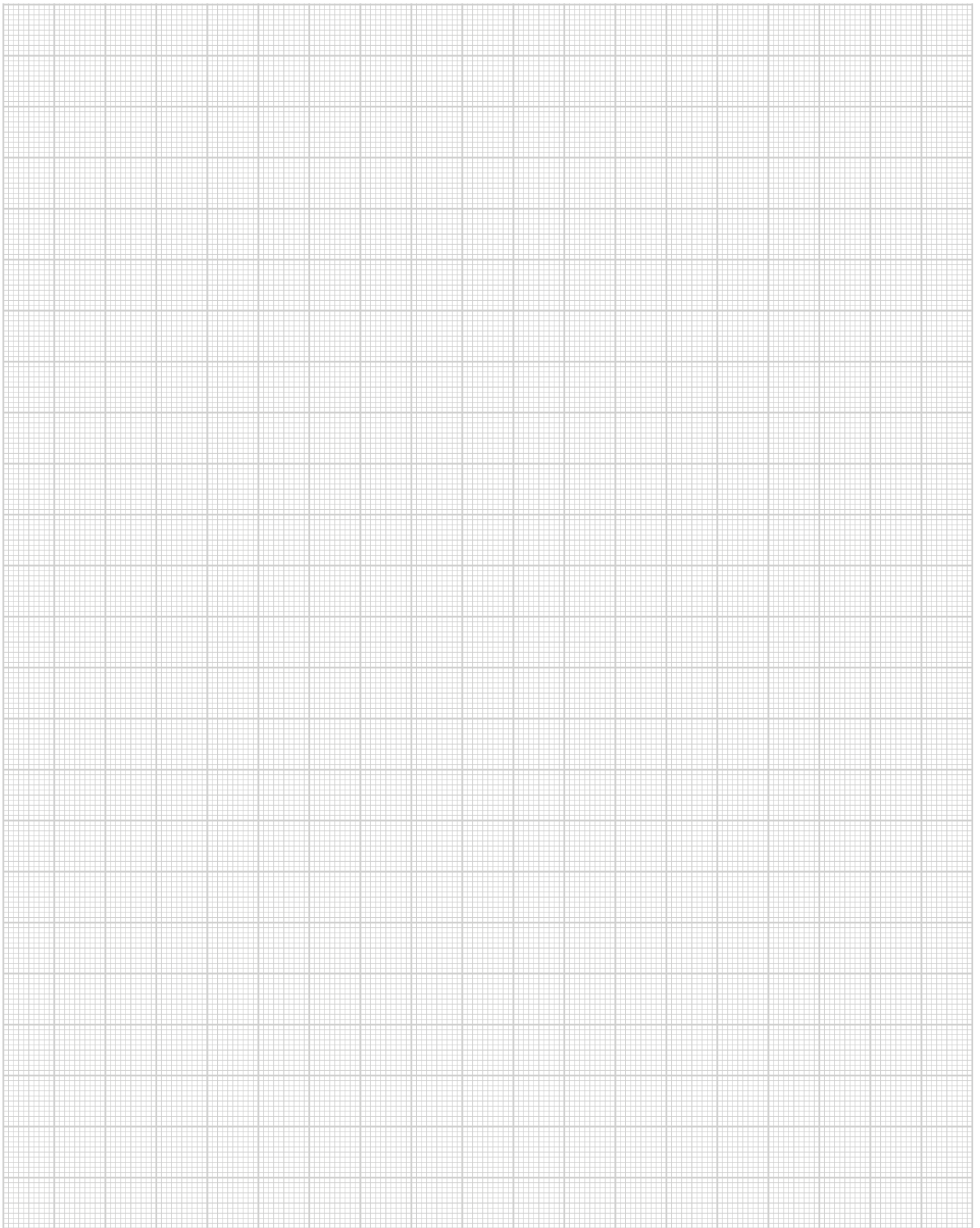

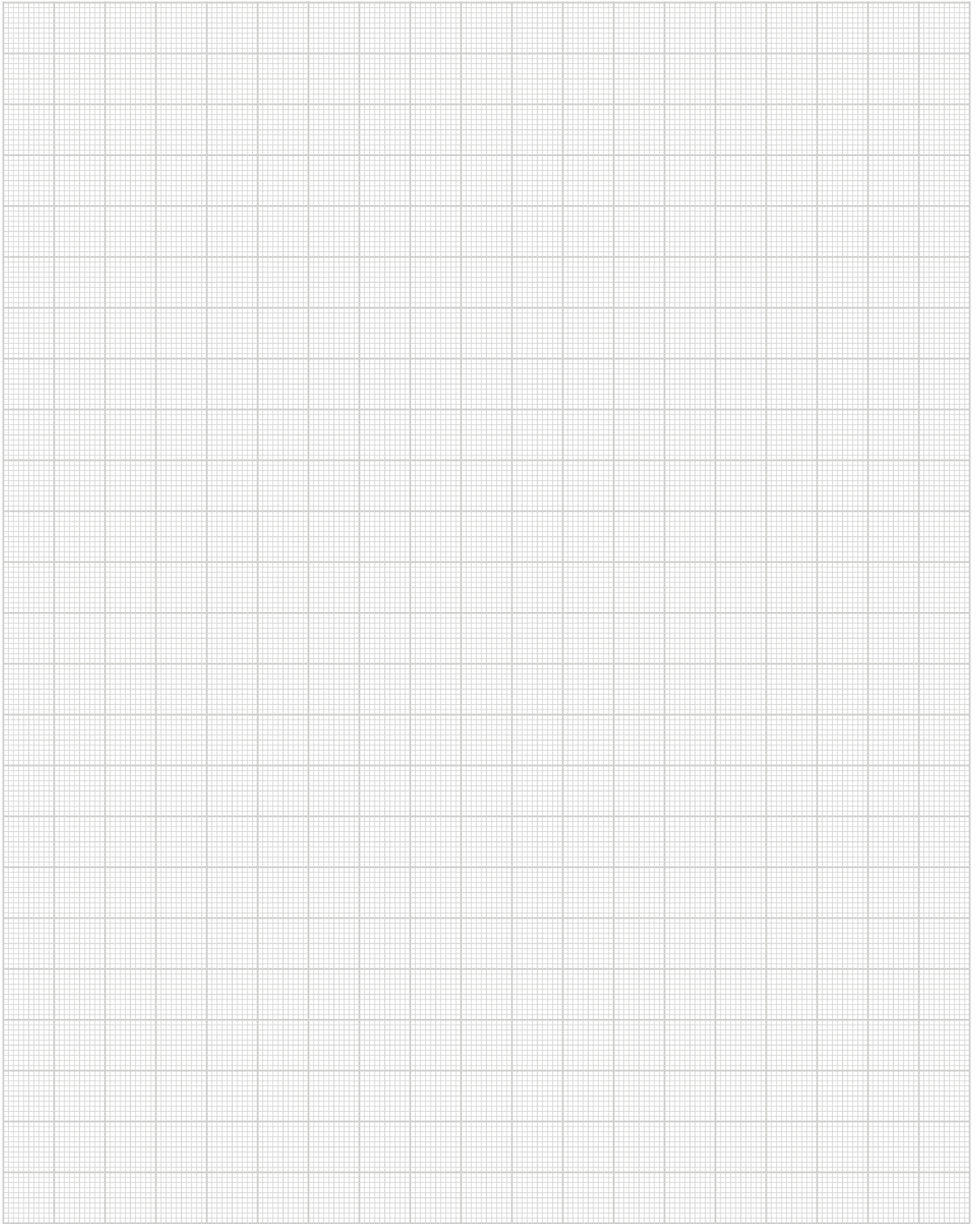

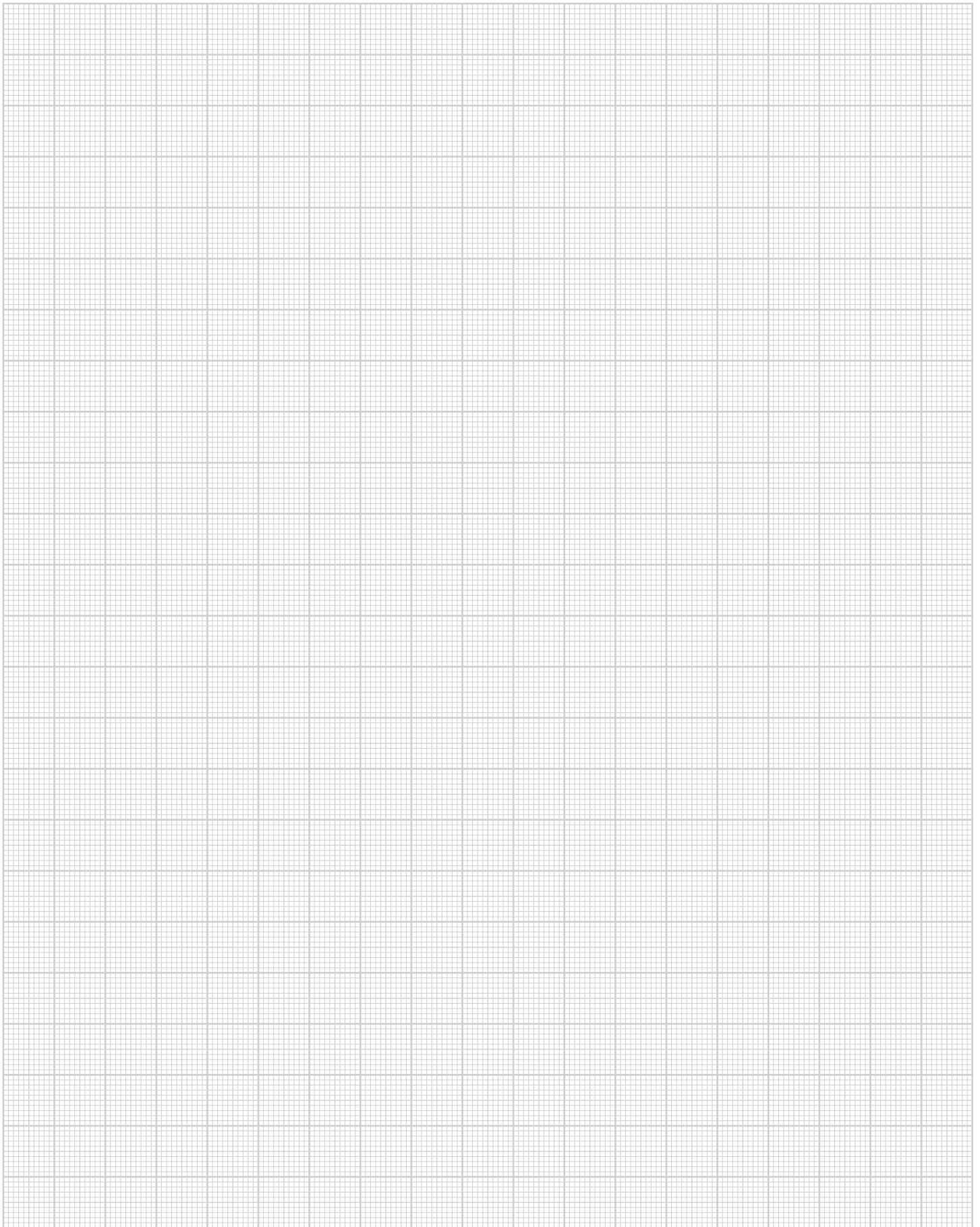



SIMPLY FILL OUT THE FORM AND SEND TO

Fax: +49 2391 8105 375 or E-mail: info@mj-geruest.de

Company	Customer no.
---------	--------------

Street	Phone
--------	-------

Postal code, city, country	Fax
----------------------------	-----

Name of buyer	E-mail
---------------	--------

 ORDER INQUIRY
Order/Quotation please send by post by fax by e-mail

PRODUCT DESCRIPTION	ARTICLE NO.	QUANTITY	UNIT PRICE €	TOTAL VALUE €

ORDER VALUE €

All prices exclude VAT applicable at the time of shipment. All dimensions and weights are non-binding approximate values. Technical data is subject to change without prior notice. Prices are charged as applicable on the day of shipment. Sale is subject exclusively to our sales terms and delivery conditions. In brief: place of business and jurisdiction is Plettenberg. Extended reservation of property rights until full payment of all our outstanding accounts are received. Our prices are ex work.

Date of delivery	Shipping method
------------------	-----------------

Delivery address:	Freight costs
-------------------	---------------

	Terms of delivery
--	-------------------

	Terms of payment
--	------------------

	MJ-Consultant
--	---------------

Stamp/Signature

Date

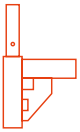
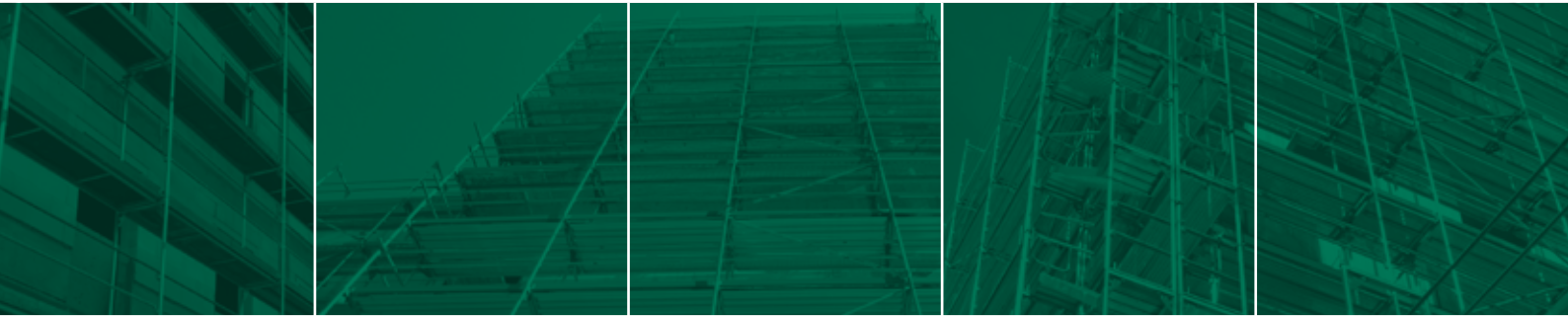

UNI-CONNECT

07er Frame scaffold

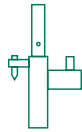

UNI

Metric frame scaffold

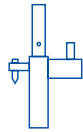

UNI TOP

Metric frame scaffold

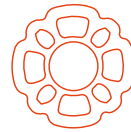

COMBI

Modular scaffold

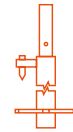

OPTIMA

Flexible façade scaffolding

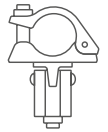

ACCESSORIES

Universal

