



MJ-GERÜST
Scaffolding Systems

**SCAFFOLDING MADE IN
PLETTENBERG**

COMBI METRIC / TOP



PRICES | EDITION 10.2022

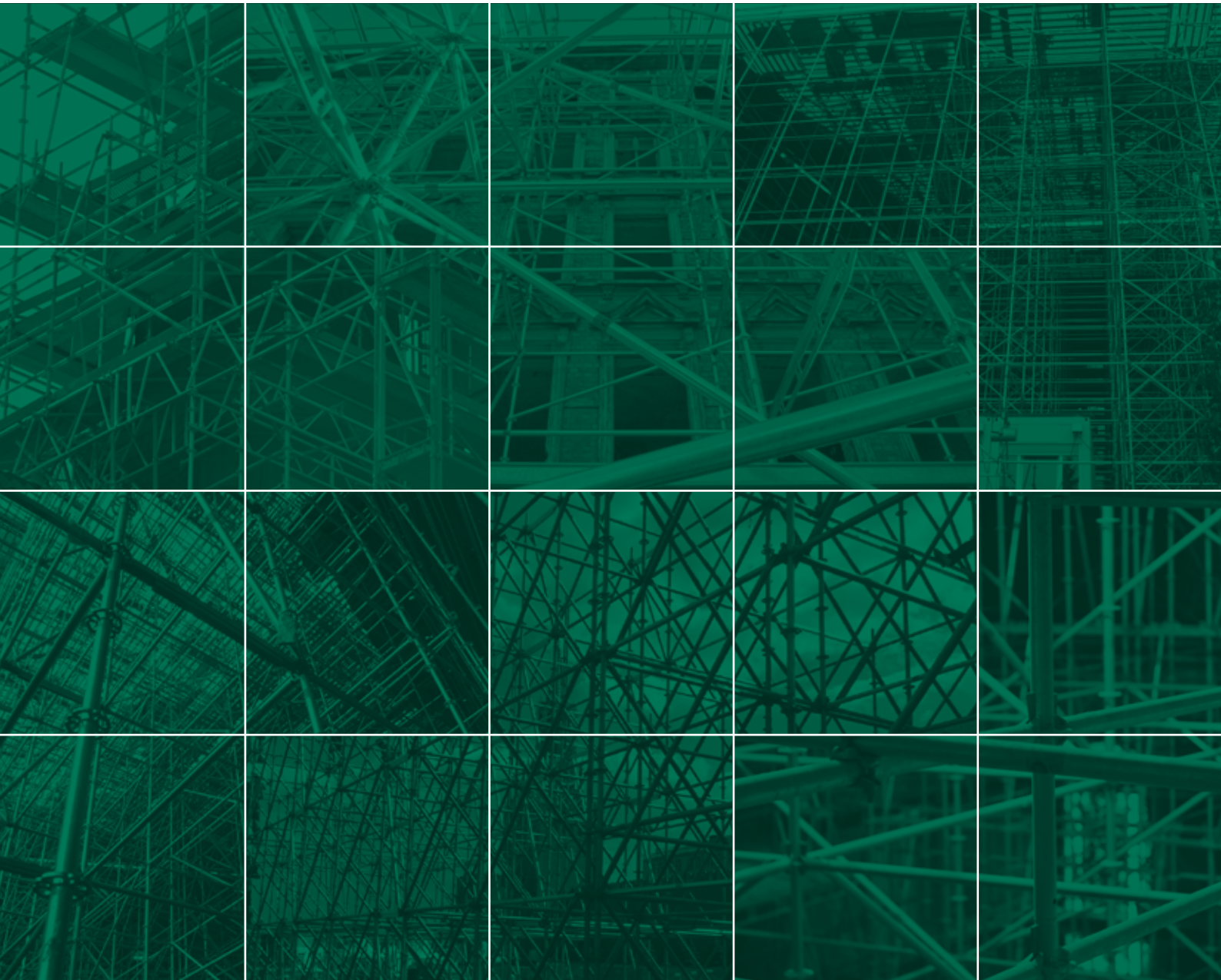

SCAFFOLDINGS MADE IN PLETTENBERG

MJ-Gerüst GmbH, based in Plettenberg in the German region of Sauerland, is part of a strong group of companies, which can look back on more than 50 years of company history. The core competence of the family company lies in the production and worldwide distribution of high-quality steel and aluminum scaffolding systems, which offer almost limitless possibilities in the field of modern system scaffolding construction.

With a unique range of products and a wide range of universal accessories, we offer our customers the option of completing existing scaffolding material in a system-compatible complement. A highly valued advantage by our customers that has given our scaffolding international recognition and prominence.

Development, production and sales. These are the cornerstones of our range of services, which are supplemented by numerous additional services. Especially our support in the planning and implementation of difficult projects is claimed. A service in which our technical know-how and experience can often contribute to considerable time and cost savings.

Only through qualified work can a safe quality product be created. Our proven quality management reflects our knowledge and experience and makes the quality of our products measurable. In order to guarantee our high quality standards, our production processes are constantly accompanied by external examination offices and engineers.



OUR COMPANY - YOUR BENEFITS

- Production in Germany at the location Plettenberg
- System compatible, high quality and norm compliant scaffold systems
- Certifications according to DIN EN 9001, 14001 and 50001
- Highest product quality through dynamic quality management
- Short-term availability of material due to high storage capacities and short decision-making processes
- Use of the modern production technology and permanent optimization of technological production running
- Project support already in the planning phase

PARTNER AND CERTIFICATES



**Our team is always available
for technical questions**

WWW.MJ-GERUEST.DE

The system	04
Superior load values	06
Base jacks	08
Vertical standards	10
Protection / Protective elements	13
Horizontal ledgers	14
Diagonal bracing	18
Horizontal diagonal bracing	19
Decks	20
Climb up	24
Stair tower	29
Deck fastenings	30
Toe boards	31
Brackets	33
Couplers, scaffold tubes	35
Anchoring	38
The safety enclosure OPTI-BOARD	39
Storage and transport	41
Securing during assembly of the scaffold	43
Notes	45
Order form	47

 Made in Plettenberg

 Net price, not discountable

 European standard

 Grant BG BAU

 Individual identification

 Delivery time on request

All prices exclude VAT applicable at the time of shipment. All dimensions and weights are non-binding approximate values. Technical data is subject to change without prior notice. Prices are charged as applicable on the day of shipment. Sale is subject exclusively to our sales terms and delivery conditions. An excerpt: place of business and jurisdiction is Plettenberg. Extended retention of title until full payment of all outstanding claims. Our prices are ex works.

COMBI: FAST - STRONG - FLEXIBLE

With the modular scaffolding COMBI, we have developed a system that covers all requirements of constructive scaffolding. COMBI is based on the proven and flexible functionality of the modular perforated disc. For the construction of the knot design, we used the finite element method (FEM) in order to achieve stress-optimized lifting capacity and weight reduction at the same time. In addition, this resulted in an optimized load application via the ledgers into the standards.

As a result, the COMBI convinces with its exceptional static values. With up to eight connections per knot – freely selectable in heights of 0.50 m intervals – the system offers the highest possible variability in constructing a modular scaffold. The small notches of the perforated disc are used to connect the ledgers and enforce a 90-degree angle, which is required for many forms of application.

In connection with the larger notches arranged in between, the system also offers variable assembly options for angles outside the 90-degree. The decisive benefit of the modular scaffold – apart from the freely definable angles of knots – is the option for individual selection of bay lengths, widths and level heights. This enables flexible adjustments to virtually any type of building or construction.



EFFICIENT

due to optimized ease of assembly



PROFITABLE

through long life and excellent value retention



FLEXIBLE

through countless field lengths/widths



VERSATILE

through extensive range of accessories

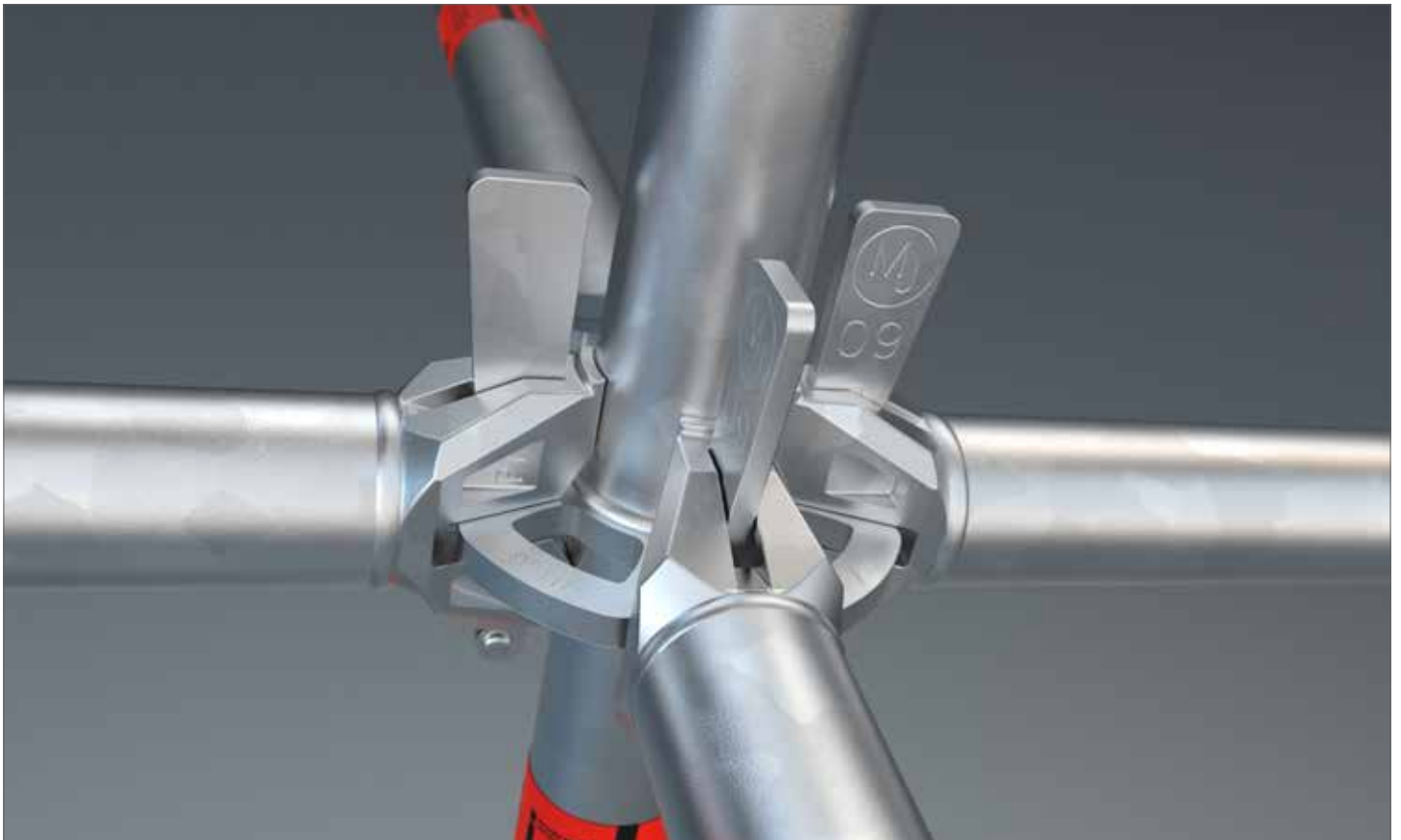

THE ESSENTIAL BENEFITS OF THE SYSTEM IN OVERVIEW

There are many reasons for choosing the COMBI modular scaffolding system: not least of these is its extensive range of series-manufactured components, for example, crossbars and diagonals in more than 100 different lengths, as well as brackets in various widths - making the COMBI an 'allrounder' in its field. The use of system base crossbars allows standard scaffolding decks of various facade scaffold systems to be integrated without any difficulty.

Gen. approved by building inspection, also for common, manufacturer independent use. For details on type and scope, please refer to the approval models: Z-8.22-921, Z-8.22-923, Z-8.22-926, Z-8.22-960.



Visit us on



WWW.GERUESTLAGER.DE

COMBI, STEEL: LOAD CAPACITY																			
Ledger type	O-ledger													O-ledger reinforced		O-double ledger			
Ledger length (system dimension) [m]	0.39	0.42	0.73	1.04	1.09	1.29	1.40	1.54	1.57	2.07	2.57	3.07	4.14	1.09	1.29	1.57	2.07	2.57	3.07
Evenly distributed line load (q) [kN/m]	80.7	70.0	24.3	12.7	11.6	8.5	7.3	6.1	5.9	3.5	2.3	1.6	0.9	18.5	16.8	14.9	9.9	7.5	5.3
Single load (P) in the centre of the bay [kN]	17.3	15.9	9.0	6.4	6.1	5.2	4.9	4.5	4.3	3.4	2.7	2.3	1.7	12.1	9.5	14.4	9.8	7.5	5.5

Ledger type	U-ledger*			U-ledger reinforced*				U-double ledger*				
Ledger length (system dimension) [m]	0.42	0.73	1.04	1.09	1.4	1.54	1.57	2.07	2.57	3.07		
Evenly distributed line load (q) [kN/m]	61.1	23.6	13.06	16.9	12.6	11.5	14.3	9.6	7.2	5.5		
Single load (P) in the centre of the bay [kN]	13.9	9.4	6.7	12.3	9.4	8.6	13.1	8.9	8.2	5.7		

COMBI METRIC, STEEL: LOAD CAPACITY																				
Ledger type	O-ledger													O-ledger reinforced		O-double ledger				
Ledger length (system dimension) [m]	0.25	0.41	0.5	0.74	0.75	1.0	1.1	1.25	1.39	1.5	2.0	2.5	3.0	4.0	1.39	1.5	1.5	2.0	2.5	3.0
Evenly distributed line load (q) [kN/m]	174.0	72.0	50.0	23.9	23.3	13.6	12.1	8.9	7.3	6.4	3.7	2.4	1.7	0.9	14.7	12.9	16.1	10.5	7.7	5.7
Single load (P) in the centre of the bay [kN]	27.5	16.2	13.3	8.9	8.8	6.7	6.3	5.4	4.9	4.5	3.5	2.8	2.4	1.8	11.3	8.1	15.9	10.4	8.1	5.7

COMBI, STEEL: PERMISSIBLE LOAD CLASSES FOR DECK LEVELS									
Ledger length [m]	Bay length L [m] - double-sided (d) - single-sided (s)								
	1.57		2.07		2.57		3.07		
	d	s	d	s	d	s	d	s	
O-ledger reinforced									
1.09	6	6	6	6	5	6	5	6	
1.29	6	6	6	6	5	6	5	6	
O-double ledger									
1.57	6	6	5	6	5	6	4	6	
2.07	5	6	4	6	4	5	3	5	
2.57	4	6	4	5	3	5	3	4	
3.07	3	5	3	4	2	4	1	3	

COMBI METRIC, STEEL: PERMISSIBLE LOAD CLASSES FOR DECK LEVELS									
Ledger length [m]	Bay length L [m] - double-sided (d) - single-sided (s)								
	1.50		2.00		2.50		3.00		
	d	s	d	s	d	s	d	s	
O-ledger reinforced									
1.39	6	6	5	6	5	6	4	6	
1.50	6	6	5	6	4	6	4	6	
O-double ledger									
1.50	6	6	5	6	5	6	4	6	
2.00	5	6	5	6	4	6	3	5	
2.50	4	6	4	5	3	5	3	5	
3.00	3	5	3	4	2	4	2	3	

COMBI, STEEL: PERMISSIBLE LOAD CLASSES FOR DECK LEVELS														
U-ledger					U-ledger reinforced					U-double ledger				
Ledger length [m]	Bay length L [m]				Ledger length [m]	Bay length L [m]				Ledger length [m]	Bay length L [m]			
	1.57	2.07	2.57	3.07		1.57	2.07	2.57	3.07		1.57	2.07	2.57	3.07
0.42	6	6	6	6	1.09	6	6	5	5	1.57	6	5	5	4
0.73	6	6	6	5	1.40	5	5	4	4	2.07	5	4	4	3
1.04	5	5	4	4	1.54	5	4	4	4	2.57	4	4	3	3
										3.07	3	3	2	1

All loads indicated here are permissible working loads. *For even, double-sided loading

LOAD CAPACITIES* IN THE COMBI LEDGER AND DIAGONAL CONNECTION IN ACC. WITH APPROVAL Z-8.22-921: MJ COMBI

BENDING MOMENT M_y

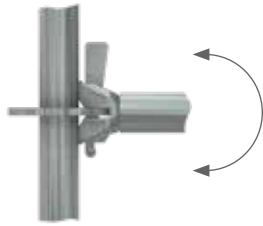

$M_{y,R,d} = \pm 110.0 \text{ kNcm}$

NORMAL FORCE N

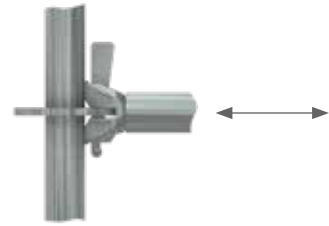

$VN_{R,d} = \pm 33.0 \text{ kN}$

TORSIONAL MOMENT M_t

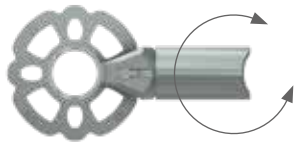

$M_{t,R,d} = \pm 64.3 \text{ kNcm}$, only O-ledger

HORIZONTAL SHEAR FORCE V_y



$V_{y,R,d} = \pm 17.3 \text{ kN}$

BENDING MOMENT M_z



$M_{z,R,d} = \pm 45.0 \text{ kNcm}$

NORMAL FORCE N_y DIAGONAL FOR BAY HEIGHT 2,00 M

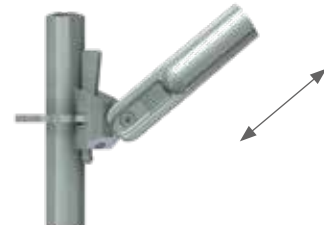

VERTICAL SHEAR FORCE V_z

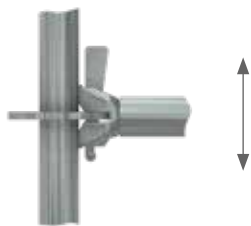

Vertical shear force, single connection: O-ledger: $V_{z,R,d} = \pm 38.3 \text{ kN}$
 U-ledger: $V_{z,R,d} = \pm 32.1 \text{ kN}$

TENSION - NORMAL FORCE

Bay length [m]	0.73	1.09	1.40	1.57	2.07	2.57	3.07	4.14
$N_{y,R,d}$ [kN]	15.9	16.6	17.5	18.1	18.5	18.5	18.5	18.5

PRESSURE - NORMAL FORCE

Bay length [m]	0.73	1.09	1.40	1.57	2.07	2.57	3.07	4.14
$N_{y,R,d}$ [kN]	-16.3	-16.8	-15.3	-14.9	-13.7	-12.2	-10.6	-6.0

A separate certificate for the perforated disc is not required.

*The loading capacity corresponds to the component resistance R_d (contains partial safety factor γ_M) 'permissible loads' or 'working loads' are obtained by dividing the loading capacity $\gamma_F = 1.5$.

BASE JACK

EN

- Steel, hot dip galvanized
- With tube spindle
- Base plate 150 x 150 mm
- For adjusting level with differences in height of the underground
- Knurled nut with collar for centring the shaft on the spindle
- Lock to prevent unscrewing of the knurled nut and to ensure the necessary bridging length
- Can be used as a head spindle



Length (m)	Weight (kg)	PU (pcs.)	Article no.	Price (€)
0,30	2,40	375	000318	17,80
0,50	3,10	300	000319	21,30
0,60	3,40	300	000320	22,00
0,78	3,90	250	000321	29,80
1,00	4,70	200	000322	35,70

SWIVEL BASE JACK

EN

- Steel, hot dip galvanized
- With tube spindle
- Swiveling base plate 150 x 150 mm
- For adjusting level with differences in height of the underground
- Knurled nut with collar for centring the shaft on the spindle
- Lock to prevent unscrewing of the knurled nut and to ensure the necessary bridging length
- Can be used as a head spindle
- Additional longitudinal scaffold bracing required at in the base
- Permissible load: 25.4 kN



Length (m)	Weight (kg)	PU (pcs.)	Article no.	Price (€)
0,50	3,10	250	000323	46,30
0,80	4,30	200	013292	54,50

BASE JACK SOLID

EN

- Steel, hot dip galvanized
- Base plate 150 x 150 mm
- For adjusting level with differences in height of the underground
- Knurled nut with collar for centring the shaft on the spindle
- Can be used as a head spindle
- Without stoppers
- Permissible load: $N_{pl,Rd} = 197 \text{ kN}$, $M_{pl,Rd} = 105 \text{ kNm}$, $V_{pl,Rd} = 85,2 \text{ kN}$



Length (m)	Weight (kg)	PU (pcs.)	Article no.	Price (€)
0,60	6,70	200	007095	47,50

SPINDLE SECURITY



- Steel, hot dip galvanized
- With half coupler
- Serves for securing spindle and castor w when moving a scaffold with a crane

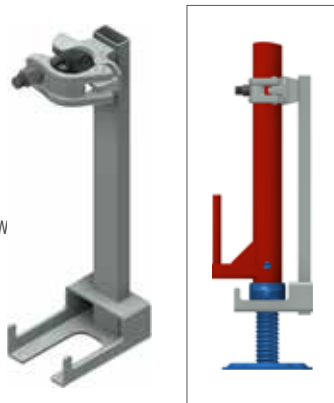

Height (m)	Weight (kg)	A/F	PU (pcs.)	Article no.	Price (€)
0,40	2,00	19	200	010294	30,20

BASE PLATE



- Steel, hot dip galvanized
- Base plate 150 x 150 mm
- With tube support approx. 60 mm high
- Directs the load from the standards to the foundation

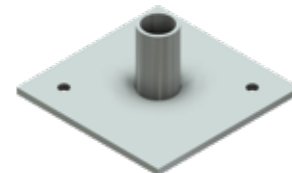

Weight (kg)	Article no.	Price (€)
1,00	000090	17,20

SPINDLE FASTENING WITH WEDGE HEAD



- Steel, hot-dip galvanized
- Securing the base jack (and the starting collar) when lifting the scaffold with a crane
- Not suitable as a lift protection



Length (m)	Weight (kg)	PU (pcs.)	Article no.	Price (€)
0,64	2,40	200	007165	30,90

PROTECTIVE PAD FOR BASE JACK

- Plastic
- With reflector

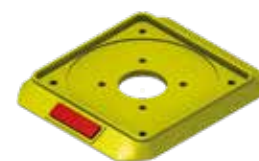

PU (pcs.)	Article no.	Price (€)
80	008110	4,40

HEAD JACK

- Steel, hot dip galvanized
- Supporting element for support and platform scaffolding as well as for formwork scaffolds
- Used to hold squares timbers, laminated beams and formwork beams



Opening dimension (mm)	Weight (kg)	PU (pcs.)	Article no.	Price (€)
148	5,60	200	000693	40,60
180	8,30	-	011537	49,90

UNDERLAY WOODS

- As a load-distributing support
- Sawn
- Dimension +/- 10 mm



Length (m)	Width (m)	Height (m)	Weight (kg)	PU (pcs.)	Article no.	Price (€)
1,00	0,24	0,04	1,50	80	009203	10,20
1,50	0,24	0,04	2,25	80	010360	12,30

STARTING COLLAR



- With perforated disc
- Forms the scaffold base together with base jacks
- Vertical standards is placed in the starting collar for further assembly



Length (m)	Weight (kg)	Article no.	Price (€)
0,23	1,40	004833	15,30
0,43	2,50	004525	39,40

VERTICAL STANDARD WITH EXTRUDED TUBE CONNECTOR



- Steel tube \varnothing 48.3 x 3.2 mm, hot dip galvanized
- Drilled in the upper and lower part for tension-proof connection
- Perforated discs at a distance of 0.50 m for up to eight connections
- Posts with extruded tube connectors upto a certain height can also be used for suspended scaffolds or when moving by crane



Height (m)	Weight (kg)	PU (pcs.)	Article no.	Price (€)
0,50	3,20	80	000696	25,70
1,00	5,20	40	000706	33,10
1,50	7,70	40	000719	47,10
2,00	9,80	40	000727	53,90
2,50	12,10	40	000764	73,60
3,00	14,40	40	000738	80,00
3,50	16,70	40	002892	95,80
4,00	18,50	40	000745	102,50

VERTICAL BASE STANDARD



- Steel, hot dip galvanized
- With additional lower perforated disc
- As an alternative for use in the lowest scaffold level without a starting collar



Height (m)	Weight (kg)	PU (pcs.)	Article no.	Price (€)
0,66	4,20	40	005751	37,00
1,16	6,50	40	005752	50,70
2,16	11,00	40	004712	74,60
3,16	15,40	40	005753	104,80

VERTICAL STANDARD WITHOUT TUBE CONNECTOR



- Steel tube \varnothing 48.3 x 3.2 mm, hot dip galvanized
- For tensile strength in upper and lower part drilled
- Perforated discs at a distance of 0.50 m for up to 8 connections
- But drilled twice at top and bottom
- In connection with the screw-in tube connector (Article no. 005114), the optimal solution for suspended scaffolding

Height (m)	Weight (kg)	PU (pcs.)	Article no.	Price (€)
0,50	2,80	40	000697	27,80
1,00	4,30	40	000707	35,30
1,50	6,80	40	000720	50,40
2,00	8,90	40	000728	57,90
2,50	11,20	40	000765	79,00
3,00	13,50	40	000739	85,70
4,00	17,60	40	000746	106,10



TUBE CONNECTOR FOR VERTICAL STANDARD



- Including two special screws M 12 x 65 (Article no. 010697) and two locking nuts (Article no. 005817)

Length (m)	Weight (kg)	Article no.	Price (€)
0,52	2,00	005114	13,40



HEXAGON BOLT M12 X 65



- For fixing the tube connector (Article no. 005114) to the vertical standard



Weight (kg)	PU (pcs.)	Article no.	Price (€)
0,06	100	010697	3,80

SELF-LOCKING NUT M12



- For fixing the tube connector (Article no. 005114) to the vertical standard



Weight (kg)	PU (pcs.)	Article no.	Price (€)
0,02	200	005817	0,60

TUBE FOLDING PLUG 12 X 60



- Galvanized

Weight (kg)	PU (pcs.)	Article no.	Price (€)
0,085	100	012057	2,40



SUSPENDED SCAFFOLD CONNECTOR 

- Steel, hot dip galvanized
- Installed in pairs
- Can be used for tension-free connection of post ends when using as suspended scaffold or when moving by crane
- Permissible load: 18 kN

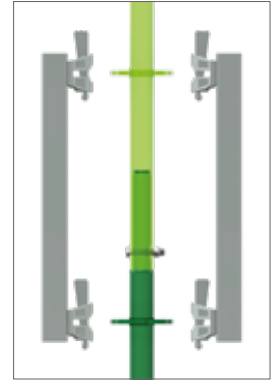

Length (m)	Weight (kg)	Article no.	Price (€)
0,50	3,61	005115	43,00

TUBE CONNECTOR  Z

- Steel, hot dip galvanized
- With U-bracket
- For wedge head connection
- For use for lattice, tubes or ledger (Not for U-Ledger)



Length (m)	Weight (kg)	Article no.	Price (€)
0,20	1,90	009726	27,60

TUBE CONNECTOR WITH HALF COUPLER 

- Steel, hot dip galvanized
- Screw fitting for lattice beams tube or ledger



Length (m)	Weight (kg)	A/F	Article no.	Price (€)
0,30	1,80	22	000223	27,60
0,30	1,80	19	000222	27,60

TUBE CONNECTOR WITH U-BACKET 

- Steel, hot dip galvanized
- For further construction e.g. for bridging while maintaining the scaffold grid

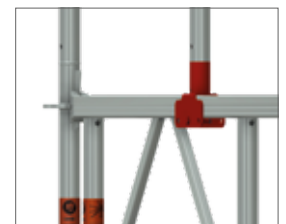

Length (m)	Weight (kg)	A/F	Article no.	Preis (€)
0,30	2,00	19	008290	33,70

SECURITY PIN



- For securing the scuffold joints against unintentional lift off, for example, when moving scuffold units with a crane or in special wind conditions



Diameter (cm)	Weight (kg)	PU (pcs.)	Article no.	Price (€)
0,90	0,15	100	000508	1,40
1,10	0,15	100	006241	1,50

PROTECTIVE SLEEVE

- Plastic
- For covering the perforated disk



Weight (kg)	PU (pcs.)	Article no.	Price (€)
0,06	40	009772	7,00

TUBE PROTECTION ONE-PIECE

- Protective cap for tube \varnothing 48.3 mm



Model	Weight (kg)	PU (pcs.)	Article no.	Price (€)
1-reflector	0,10	60	011281	3,60

TUBE PROTECTION TWO-PIECE

- Protective cap for tube \varnothing 48.3 mm



Model	Weight (kg)	PU (pcs.)	Article no.	Price (€)
2-reflector	0,15	60	011282	3,80

LEDGER METRIC



- Steel, hot dip galvanized
- With wedge head connections for attachment to the perforated discs
- For use as a support ledger for holding decks with tube support, as bracing element and as guard rail
- In deck levels bracing ledgers can be omitted if system decks and these are secured against taking off



Length (m)	Weight (kg)	PU (pcs.)	Article no.	Price (€)
0,25	1,40	100	005620	27,00
0,41	2,00	100	005653	28,00
0,50	2,20	100	004834	29,00
0,65	2,90	100	006237	31,80
0,74	3,55	50/100	004510	30,00
0,75	3,60	50/100	000748	30,00
1,00	4,00	50/100	000809	30,90
1,10	4,20	50/100	000763	32,20
1,25	4,90	50/100	005654	37,00
1,39	5,40	50/100	005655	37,00
1,50	6,10	50/100	000749	37,00
2,00	7,60	50/100	000750	43,20
2,50	9,40	50/100	000751	49,30
3,00	10,90	50/100	000752	55,50
4,00	13,30	100	004512	79,40

REINFORCED LEDGER METRIC



- Steel, hot dip galvanized
- With wedge head connections
- To support platforms for tube support with higher loads



Width (m)	Weight (kg)	PU (pcs.)	Article no.	Price (€)
1,39	9,10	50	005656	66,20
1,50	9,90	50	000790	66,20

DOUBLE LEDGER METRIC



- Steel, hot dip galvanized
- With wedge head connections
- With bracing joist to support platforms with tube support for high loads or larger spans



Width (m)	Weight (kg)	PU (pcs.)	Article no.	Price (€)
1,50	9,50	50	000759	80,80
2,00	12,60	50	000760	93,70
2,50	15,70	50	000792	111,60
3,00	18,50	50	000793	128,00

DECK LEDGER METRIC



- Steel, hot dip galvanized
- With wedge head connectors
- For use with standard UNI decks



Width (m)	Weight (kg)	PU (pcs.)	Article no.	Price (€)
0,41	2,10	50	005668	34,80
0,74	3,20	50	004517	39,30
1,10	5,30	50	004518	60,10

DECK LEDGER REINFORCED METRIC



- Steel, hot dip galvanized
- With wedge head connectors
- For use with standard UNI decks
- Deck ledger with width 1.39 m suitable for aluminum stairs with platform



Width (m)	Weight (kg)	PU (pcs.)	Article no.	Price (€)
1,39	7,20	50	005670	82,70

DOUBLE DECK LEDGER METRIC 

- Steel, hot dip galvanized
- With wedge head connections
- With bracing joist to support serial UNI decks with high loads or larger spans
- Please note our instructions for assembly and use for the correct arrangement of the decks



Width (m)	Weight (kg)	PU (pcs.)	Article no.	Price (€)
1,50	9,40	40	004513	96,50
2,00	12,50	40	004514	128,00
2,50	15,50	40	004515	150,30
3,00	18,50	40	004516	173,30

DECK LEDGER UT-SUPPORT 

- Steel, hot dip galvanized
- With wedge head connectors
- With recesses to accommodate MJ deck locks

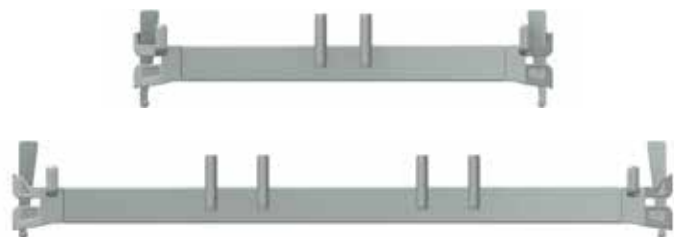

Width (m)	Weight (kg)	PU (pcs.)	Article no.	Price (€)
0,65	3,60	50	011712	32,90
1,00	5,10	50	011713	58,00

INTERMEDIATE LEDGER METRIC 

- Steel, hot dip galvanized
- For supporting system-free scaffold boards or for access decks with tube support
- Are placed on longitudinal ledgers

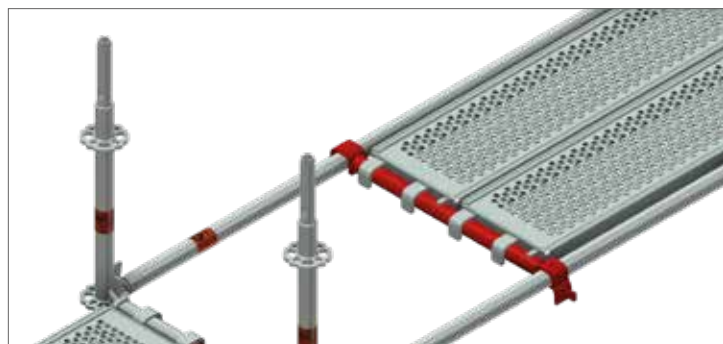

Width (m)	Weight (kg)	PU (pcs.)	Article no.	Price (€)
0,74	3,70	50	005657	34,00
0,75	3,90	50	005658	34,40
1,00	4,60	50	005659	34,90

INTERMEDIATE DECK LEDGER DECK TO DECK



- Steel, hot dip galvanized
- As intermediate support for shorter platforms at openings or stairway
- They are placed on both sides on steel platforms
- Resistant up to load class 3

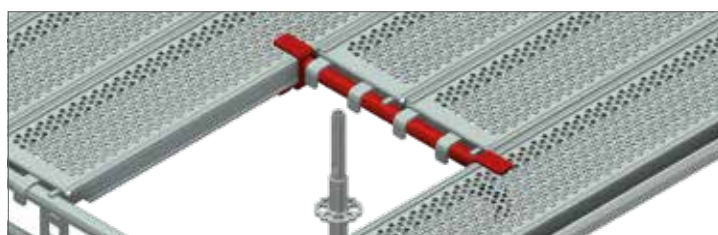

Width (m)	Weight (kg)	Article no.	Price (€)
0,32	3,30	005662	36,70
0,64	4,50	005663	40,80
0,96	5,70	005664	46,20

INTERMEDIATE DECK LEDGER EDGE



- Steel, hot dip galvanized
- As intermediate support at the end of shorter platforms
- Are placed on one side on steel platforms and on the other side on longitudinal ledgers

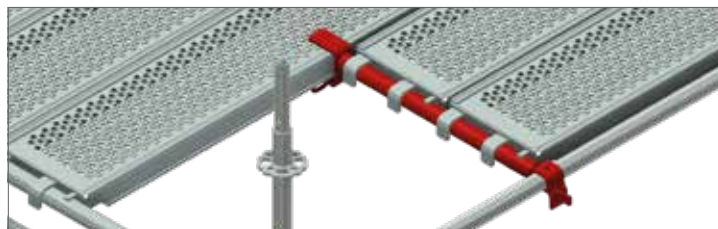

Width (m)	Weight (kg)	Article no.	Price (€)
0,32	2,70	005665	36,70
0,64	3,80	005666	43,50
0,96	4,90	005667	53,30

VERTICAL DIAGONAL BRACE METRIC 

- Steel tube Ø 48.3 x 2.3 mm, hot dip galvanized
- With swiveling wedge heads
- For bracing the vertical scaffold structure

Field height (m)	Length (m)	Weight (kg)	PU (pcs.)	Article no.	Price (€)
0,50	1,00	4,50	50	004949	48,60
0,50	1,50	5,70	50	004948	52,20
0,50	2,00	7,00	50	002184	57,80
0,50	2,50	8,20	50	005108	61,10
0,50	3,00	9,50	50	004947	65,60

Field height (m)	Length (m)	Weight (kg)	PU (pcs.)	Article no.	Price (€)
1,00	0,50	4,70	50	004946	50,10
1,00	0,74	5,00	50	004945	49,30
1,00	0,75	5,10	50	004944	49,30
1,00	1,00	5,40	50	004943	49,30
1,00	1,10	5,50	50	004942	49,30
1,00	1,25	5,80	50	004941	51,20
1,00	1,50	6,30	50	000803	52,40
1,00	2,00	7,40	50	000802	58,40
1,00	2,50	8,60	50	000801	60,40
1,00	3,00	9,80	50	000804	65,60

Field height (m)	Length (m)	Weight (kg)	PU (pcs.)	Article no.	Price (€)
1,50	0,50	6,00	50	005684	55,10
1,50	0,74	6,20	50	004939	49,40
1,50	1,00	6,40	50	004938	53,20
1,50	1,10	6,50	50	004937	53,20
1,50	1,50	7,20	50	000808	56,40
1,50	2,00	8,20	50	000797	59,10
1,50	2,50	9,20	50	000807	59,10
1,50	3,00	10,30	50	000805	64,30

Field height (m)	Length (m)	Weight (kg)	PU (pcs.)	Article no.	Price (€)
2,00	0,50	7,00	50	004791	57,80
2,00	0,65	7,10	50	006348	51,20
2,00	0,74	7,40	50	004935	50,40
2,00	1,00	7,60	50	004717	50,90
2,00	1,10	7,70	50	004934	51,40
2,00	1,25	7,70	50	007451	52,00
2,00	1,39	8,10	50	004933	52,60
2,00	1,50	8,30	50	000753	52,70
2,00	2,00	9,10	50	000755	56,20
2,00	2,50	10,00	50	000754	60,80
2,00	3,00	11,00	50	000756	61,60

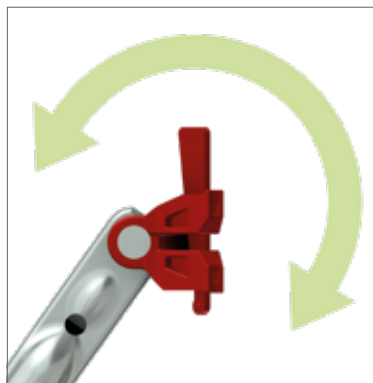

HORIZONTAL DIAGONAL BRACE METRIC



- Steel, hot dip galvanized
- Is used in birdcage scaffolds for bracing horizontal levels in square fields
- On both sides with pin hanging system
- To be secured against lifting off on site

Field length (m)	Field width (m)	Weight (kg)	PU (pcs.)	Article no.	Price (€)
2,00	0,74	5,60	50	005810	60,40
2,00	1,00	5,80	50	005685	62,40
2,00	1,50	6,50	50	005686	63,70

Field length (m)	Field width (m)	Weight (kg)	PU (pcs.)	Article no.	Price (€)
2,50	0,74	6,80	50	005687	60,80
2,50	1,00	7,00	50	005688	62,10
2,50	1,10	7,10	50	005689	63,70
2,50	1,39	7,30	50	005690	68,50
2,50	1,50	7,50	50	005691	68,50
2,50	2,00	8,20	50	004526	70,90

Field length (m)	Field width (m)	Weight (kg)	PU (pcs.)	Article no.	Price (€)
3,00	0,74	7,90	50	005692	68,50
3,00	1,00	8,10	50	005693	70,30
3,00	1,10	8,20	50	005694	70,90
3,00	1,39	8,40	50	005695	71,60
3,00	1,50	8,50	50	005696	72,90
3,00	2,00	9,10	50	005697	74,20
3,00	2,50	9,90	50	000679	76,20
3,00	3,00	10,70	50	009336	81,50

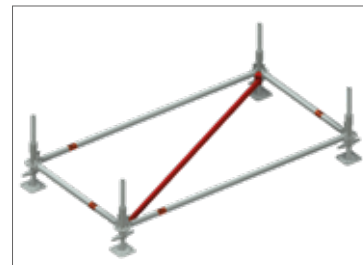
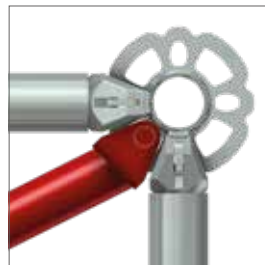

DIAGONAL LEDGER METRIC



- Steel, hot dip galvanized
- Is used in birdcage scaffolds for bracing horizontal levels in square fields
- On both sides with wedge head connections

Field width (m)	Field length (m)	Weight (kg)	PU (pcs.)	Article no.	Price (€)
0,75	0,75	4,00	50	005698	43,00
1,00	1,00	5,20	50	005699	51,90
1,50	1,50	7,40	50	005700	59,10
2,00	2,00	9,70	50	005701	72,90
2,50	2,50	11,90	50	004602	87,90
3,00	3,00	14,20	50	004601	103,10

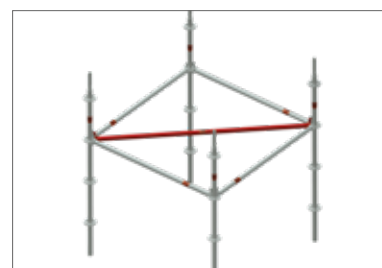
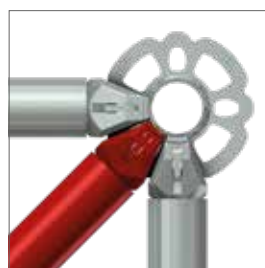

STEEL DECK TUBE SUPPORT METRIC 0.32 M

ID

- Steel, hot dip galvanized
- Non-slip surface through pronounced hole profiling
- Good stackability
- With integrated deck retainer

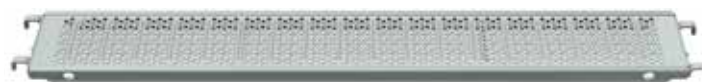

Length (m)	Width (m)	Weight (kg)	Load class	PU (pcs.)	Article no.	Price (€)
0,75	0,32	7,20	6	60/80	008791	74,80
1,00	0,32	8,70	6	60/80	008792	77,10
1,10	0,32	9,10	6	60/80	008793	77,40
1,50	0,32	12,20	6	60/80	008796	85,30
2,00	0,32	15,30	6	60/80	008797	98,40
2,50	0,32	18,40	5	60/80	008798	108,90
3,00	0,32	21,40	4	60/80	008799	122,80



STEEL DECK 0.15 M METRIC - UT



- Steel, hot dip galvanized
- Extremely robust, for the toughest operations
- Bracket deck for scaffold widening with ½ deck width, e.g. for WDVS work
- Compensating deck to close gaps in platform scaffolding
- Good stackability
- Also fits in the main scaffold instead of the standard decks

WDVS = Thermal insulation composite system



Length (m)	Width (m)	Weight (kg)	Load class	PU (pcs.)	Article no.	Price (€)
0,65	0,15	3,90	3	102	013270	70,00
0,74	0,15	4,00	3	102	013271	70,90
1,00	0,15	4,90	3	102	013272	73,50
1,10	0,15	5,00	3	102	013273	74,20
1,25	0,15	5,80	3	102	013274	78,70
1,50	0,15	6,70	3	102	013275	79,90
2,00	0,15	8,50	3	102	013276	91,90
2,50	0,15	10,30	3	102	013277	114,90
3,00	0,15	12,10	3	102	013278	121,40

STEEL DECK OPTI-LINE 0.32 M - UNI



- Steel, hot dip galvanized
- Non-slip surface through pronounced hole profiling
- Up to 3.4 kg lighter with the same load class
- Good to stackability
- With handles for length 2.50 m



**STRONGER DUE TO
NEW SURFACE**

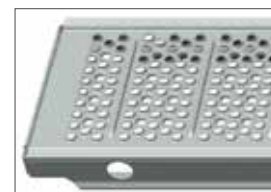

Length (m)	Width (m)	Weight (kg)	Load class	PU (pcs.)	Article no.	Price (€)
0,74	0,32	5,30	6	60/80	008840	68,30
1,10	0,32	7,30	6	60/80	008841	70,30
1,50	0,32	10,80	6	60/80	008843	79,90
2,00	0,32	13,20	6	60/80	008844	89,30
2,50	0,32	15,90	5	60/80	008845	97,80
3,00	0,32	19,25	4	60/80	008846	111,60

STEEL DECK 0.29 M - UT



- Steel, hot dip galvanized
- Non-slip surface through pronounced hole profiling
- Optimal stackability thanks to the selected cross-sectional shape
- Point welded



**STRONGER DUE TO
NEW SURFACE**



Length (m)	Width (m)	Weight (kg)	Load class	PU (pcs.)	Article no.	Price (€)
0,65	0,29	5,50	6	80	008820	60,60
1,00	0,29	7,50	6	80	008821	64,80
1,50	0,29	11,50	6	80	008822	73,80
2,00	0,29	15,00	6	80	008823	83,80
2,50	0,29	17,50	5	80	008824	95,50
3,00	0,29	21,50	4	80	008825	107,90

STEEL DECK TUBE SUPPORT 0.29 M - TOP



- Steel, hot dip galvanized
- For support on round tube \varnothing 48,3 mm
- Non-slip surface through pronounced hole profiling
- Optimal stackability thanks to the selected cross-sectional shape



Length (m)	Width (m)	Weight (kg)	PU (pcs.)	Article no.	Price (€)
0,65	0,29	5,50	80	014414	74,80
1,00	0,29	7,50	80	014413	77,10
1,50	0,29	11,50	80	014412	85,30
2,00	0,29	15,00	80	014411	98,40
2,50	0,29	17,50	80	014407	108,90
3,00	0,29	21,50	80	014410	122,80



TIMBER DECK METRIC - UNI



- Timber, 48 mm thick
- With hot dip galvanized deck caps
- Can be used on both sides
- Mechanically checked in accordance with DIN EN 14801 and DIN 4074 MS 10/13
- Waterproofed and weatherproof glued
- Can be used in guard and roof guard scaffolds as per DIN 4420 up to $L \leq 3.00$ m



Length (m)	Width (m)	Weight (kg)	Load class	PU (pcs.)	Article no.	Price (€)
0,74	0,32	6,00	6	60/80	000176	44,00
1,10	0,32	8,50	6	60/80	000175	52,00
1,50	0,32	11,50	6	60/80	000035	58,40
2,00	0,32	14,50	5	60/80	000034	66,90
2,50	0,32	18,20	4	60/80	000032	75,50
3,00	0,32	22,00	3	60/80	000030	85,30

TIMBER DECK 0.29 M - UT



- Timber, 48 mm thick
- With hot dip galvanized deck caps
- Can be used on both sides
- Mechanically checked in accordance with DIN EN 14801 and DIN 4074 MS 10/13
- Waterproofed and weatherproof glued
- Can be used in guard and roof guard scaffolds as per DIN 4420 up to $L \leq 3.00$ m



Length (m)	Width (m)	Weight (kg)	Load class	PU (pcs.)	Article no.	Price (€)
0,65	0,29	5,00	6	80	001076	44,40
1,00	0,29	7,50	6	80	001075	52,80
1,50	0,29	10,50	6	80	001074	61,20
2,00	0,29	14,00	5	80	001073	70,20
2,50	0,29	17,00	4	80	001072	78,90
3,00	0,29	21,50	3	80	001071	89,50

STEEL PLANK 0.30 M



- Steel, hot dip galvanized
- Non-slip surface through pronounced hole profiling

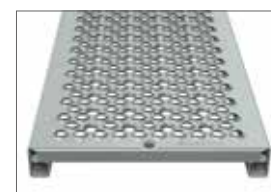

Length (m)	Width (m)	Weight (kg)	PU (pcs.)	Article no.	Price (€)	
1,00	0,30	6,75	80	013310	52,10	🕒
1,50	0,30	9,75	80	013311	61,60	🕒
2,00	0,30	12,80	80	013312	70,70	🕒
2,50	0,30	15,85	80	013313	80,30	🕒

CORNER DECK



- Steel, hot dip galvanized
- As a supplement for system decks in the inner corner area
- Non-slip surface



Model	Length (m)	Width (m)	Weight (kg)	Article no.	Price (€)
1-board	0,32	0,32	4,45	013862	89,20

COMBI ACCESS DECK TUBE SUPPORT WITH ALUMINUM DECK METRIC



- With non-slip aluminum deck
- Weather resistant, light and robust
- With integrated ladder aluminum
- Robust riveted head profiles and steel connection claws, hot dip galvanized
- Access flap open to the side



Length (m)	Width (m)	Weight (kg)	Load class	PU (pcs.)	Article no.	Price (€)
2,00	0,63	24,00	4	14	010650	378,20
2,50	0,63	25,20	4	14	002468	504,90
3,00	0,63	28,80	3	14	005727	528,30

ACCESS DECK WITH ALUMINUM DECK - UNI



- With non-slip deck aluminum
- Weather resistant, light and robust
- With integrated aluminum ladder (at length 2.00 m extendable)
- Access flap made of corrugated sheet metal, open to the side



Length (m)	Width (m)	Weight (kg)	Load class	PU (pcs.)	Article no.	Price (€)
2,00	0,63	19,00	4	14	000391	418,30
2,50	0,63	22,50	4	14	000389	426,60
3,00	0,63	25,00	3	14	000390	469,30

COMBI ACCESS DECK WITH ALUMINUM DECK - UT



- With non-slip aluminum deck
- Weatherproof, light and robust
- With integrated aluminum ladder (telescopic for a length of 2.00 m)
- Access hatch made of corrugated sheet metal, opens to the side



Length (m)	Width (m)	Weight (kg)	Load class	PU (pcs.)	Article no.	Price (€)
2,00	0,60	22,50	4	14	009456	360,00
2,50	0,60	22,90	4	14	003706	380,00
3,00	0,60	25,00	3	14	003707	420,00

COMBI ACCESS DECK WITH PLYWOOD PANEL - UNI



- With water-resistant, non-slip and lightweight plywood panel 12 mm, BFU-100 G-12
- With integrated aluminum ladder
- Access flap open to the side

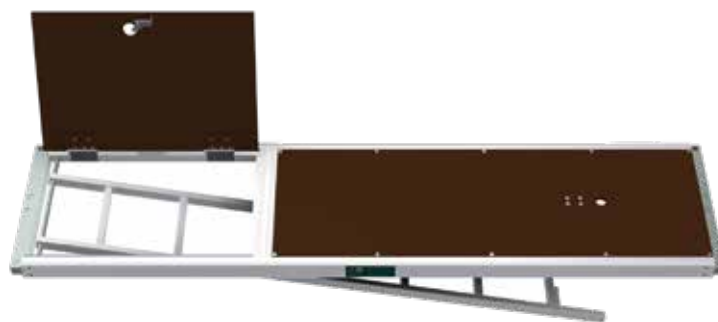

Length (m)	Width (m)	Weight (kg)	Load class	PU (pcs.)	Article no.	Price (€)
2,50	0,63	25,00	3	14	000388	387,20
3,00	0,63	28,00	3	14	000387	439,70

ACCESS LADDER



- As a separate ladder for the inside scaffold ascent
- With riveted claws for safe mounting to the access decks

Model	Length (m)	Width (m)	Weight (kg)	PU (pcs.)	Article no.	Price (€)
Aluminium	2,16	0,40	3,00	–	001323	80,70
Steel	2,16	0,40	10,50	80	000172	79,90



VERTICAL LADDER ALUMINIUM



- Suited for all scaffold types, may also be used for ladder scaffolds
- TÜV inspected
- With riveted tube connectors
- Distance between rungs 28 cm
- Is fastened with standard couplers
- Plastic base included

Length (m)	Width (m)	Weight (kg)	PU (pcs.)	Article no.	Price (€)
2,00	0,47	5,80	20	000409	160,30
3,00	0,47	8,00	20	000410	174,50
4,00	0,47	10,00	20	000411	226,00
5,00	0,47	12,60	20	000412	275,00
6,00	0,47	14,50	20	000413	325,70

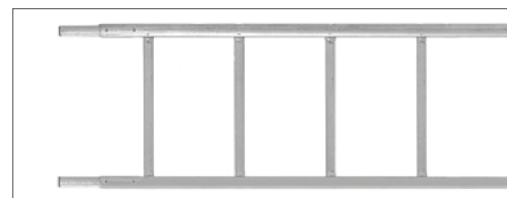

VERTICAL LADDER STEEL

- The posts are steel tube $\varnothing 48.3 \times 3.2$ mm, hot dip galvanized
- Standard coupler connection is ensured
- This robust ladder has become the first choice in industry for heavy-duty applications
- The ladder can be extended using normal tube connectors

Length (m)	Width (m)	Weight (kg)	PU (pcs.)	Article no.	Price (€)
2,00	0,45	21,00	20	000227	126,60
3,00	0,45	28,50	20	000228	174,70
4,00	0,45	34,50	20	000229	240,00
5,00	0,45	44,50	20	000230	309,90

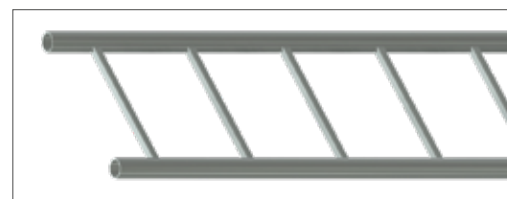

ALUMINUM STAIRS WITH PLATFORM AND TUBE SUPPORT METRIC



- Bay height 2.00 m
- Scaffold stairway for the planned construction with facade scaffolding
- For quick and safe mounting of the scaffold levels
- The steps are designed in a non-slip manner and allow comfortable outside access for extensive use of scaffold and when transporting bulky material, without reducing the work surface in the main walkway
- Evenly distributed area load $p = 2.5 \text{ kN/m}^2$
- Single load distributed on $0.2 \times 0.2 \text{ m}^2 F = 1.5 \text{ kN}$
- Meets the requirements according to DIN EN 12811-1



Field length (m)	Length (m)	Width (m)	Weight (kg)	PU (pcs.)	Article no.	Price (€)
2,50	3,25	0,64	28,50	10	005746	549,90
3,00	3,65	0,64	33,50	10	005747	622,00

ALUMINUM STAIRS WITH PLATFORM METRIC - UNI



- Bay height 2.00 m
- Scaffold stairway for the planned construction with facade scaffolding
- For quick and safe mounting of the scaffold levels
- The steps are designed in a non-slip manner and allow comfortable outside access for extensive use of scaffold and when transporting bulky material, without reducing the work surface in the main walkway
- Evenly distributed area load $p = 2.5 \text{ kN/m}^2$
- Single load distributed on $0.2 \times 0.2 \text{ m}^2 F = 1.5 \text{ kN}$
- Meets the requirements according to DIN EN 12811-1



Field length (m)	Length (m)	Width (m)	Weight (kg)	PU (pcs.)	Article no.	Price (€)
2,50	2,00	0,64	22,50	10	000417	549,90
3,00	3,60	0,64	33,00	10	000418	609,90

ALUMINUM STAIRS WITH PLATFORM - UT



- For bay height 2.00 m
- Scaffold stairway for the planned construction with facade scaffold
- For quick and safe mounting of the levels
- The steps are designed in a non-slip manner and allow comfortable outside access for extensive use of scaffold and when transporting material, without reducing the work surface in the main walkway
- Evenly distributed line load $p=2.5 \text{ kN/m}^2$
- Single load distributed on $0.2 \times 0.2 \text{ m}^2 F=1.5 \text{ kN}$
- Meets the requirements according to DIN EN 12811-1



Field Length (m)	Length (m)	Width (m)	Weight (kg)	PU (pcs.)	Article no.	Price (€)
2,50	3,25	0,55	20,00	10	000394	501,60

SINGLE OUTSIDE STAIRCASE HANDRAIL METRIC



- Steel, hot dip galvanized
- To connect to the COMBI perforated disk



Field height (m)	Length (m)	Weight (kg)	Article no.	Price (€)
2,00	2,50	10,90	005748	91,20
2,00	3,00	12,40	005749	106,20

INSIDE STAIRCASE HANDRAIL



- Steel, hot dip galvanized
- For aluminum platform stairs
- Can be used for field wide 2.50 and 3.00 m
- For mounting to the stair string
- Integrated end plug on the handrail for protection



Length (m)	Weight (kg)	A/F	PU (pcs.)	Article no.	Price (€)
2,25	11,50	19	20	000425	137,80
2,25	11,50	22	20	006942	137,80

ROUND INSIDE GUARD RAIL



- Steel, hot-dip galvanized
- For aluminum platform stairs
- For mounting to the stair string

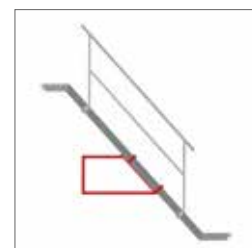

Weight (kg)	A/F	PU (pcs.)	Article no.	Price (€)
5,80	19	40	009226	69,60

ALUMINUM BEGINNING STAIRS WITH PLATFORM AND TUBE SUPPORT METRIC



- Beginning stair with integrated base jack receptacles
- For fast and safe access to the scaffold levels

Height (m)	Length (m)	Width (m)	Weight (kg)	PU (pcs.)	Article no.	Price (€)
0,50	1,50	0,64	5,30	10	010814	291,00

ALUMINUM BEGINNING STAIRS WITH PLATFORM METRIC - UNI



- Beginning stair with integrated base jack receptacles
- For fast and safe access to the scaffold levels

Height (m)	Length (m)	Width (m)	Weight (kg)	PU (pcs.)	Article no.	Price (€)
1,00	1,50	0,64	10,70	10	000395	334,70
1,50	1,75	0,64	19,00	15	009944	458,50



ALUMINUM BEGINNING STAIR WITH PLATFORM - UT



- Beginning stair with integrated base jack mounts
- Scaffold stairway for the planned construction with facade scaffolding
- For quick and safe mounting of the scaffold levels
- The steps are designed in a non-slip manner and allow comfortable outside access for extensive use of scaffold and when transporting bulky material, without reducing the work surface in the main walkway

Field height (m)	Length (m)	Width (m)	Weight (kg)	PU (pcs.)	Article no.	Price (€)
1,00	1,50	0,55	11,20	10	007362	299,70



STAIRCASE HANDRAIL FOR PLATFORM STAIRS



- Steel, hot-dip galvanized
- For aluminium beginning stairs with platform 1.00 m / 1,50 m
- For easy mounting on overhanging threaded rod including connection with half-coupler

Weight (kg)	Article no.	Price (€)
11,50	014964	135,70



STAIR TOWER



**COMPONENTS FOR STAIR TOWER CAN
BE FOUND IN OUR PRICE LIST „COMBI“**

DECKING FASTENER UNI-SUPPORT METRIC 

- Steel, hot dip galvanized
- To secure against lift off decks and for mounting toe boards
- With toe board bracket

Width (m)	Weight (kg)	PU (pcs.)	Article no.	Price (€)
0,74	1,80	50	013405	30,70
1,10	2,20	50	013821	41,50
1,39	3,90	50	005679	42,70
1,50	4,10	50	005680	45,70
2,00	5,00	50	005681	59,10
2,50	5,90	50	005682	69,60
3,00	6,80	50	005683	76,10

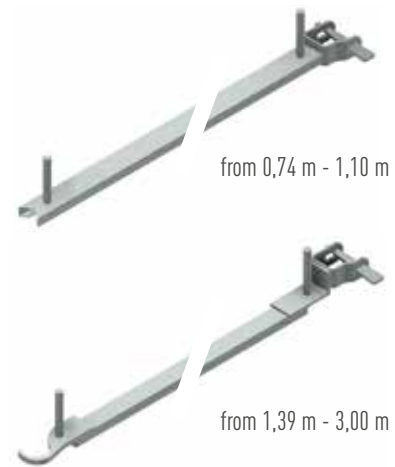

DECK FASTENING UT-SUPPORT 

- Steel, hot dip galvanized
- With two hooks for locking in MJ deck ledgern

Width (m)	Weight (kg)	Article no.	Price (€)
0,65	1,20	012724	34,40
1,00	1,80	012725	41,30



DECK FASTENING WITH WEDGE 

- Steel, hot dip galvanized
- For preventing decks from lifting off
- With wedge head connection



Weight (kg)	Article no.	Price (€)
0,70	006850	14,60

DECK FASTENING WITH HALF COUPLER 

- Steel, hot dip galvanized, drop-forged
- For securing decks against lifting off



A/F	Weight (kg)	Article no.	Price (€)
19	1,10	008156	26,00
22	1,15	008157	15,80

TOE BOARD TUBE-SUPPORT METRIC



- Timber
- Galvanized steel fittings
- To complete the three-part side protection

Length (m)	Height (m)	Weight (kg)	PU (pcs.)	Article no.	Price (€)
0,74	0,15	1,90	80	006589	20,60
0,75	0,15	1,90	80	005728	20,60
1,00	0,15	2,30	80	005729	22,80
1,10	0,15	2,40	80	005730	22,80
1,50	0,15	3,20	80	000786	25,10
2,00	0,15	4,20	80	005731	27,00
2,50	0,15	5,10	80	000788	29,00
3,00	0,15	6,00	80	000789	32,00



TOE BOARD



- Timber
- Galvanized steel fittings
- To be inserted between the frames

Length (m)	Weight (kg)	PU (pcs.)	Article no.	Price (€)
0,65	2,00	70	001109	19,10
1,00	2,50	70	001108	20,50
1,50	3,00	70	001107	22,40
2,00	5,00	70	001106	24,60
2,50	5,50	70	001105	26,40
3,00	6,50	70	001104	29,30
4,00	10,00	70	002616	64,40



TOE BOARD METRIC - UNI



- Timber
- Galvanized steel fittings
- To complete the three-part side protection in conjunction with UNI decks
- Easy mounting on the toe board bolts of the deck fastener

Length (m)	Height (m)	Weight (kg)	PU (pcs.)	Article no.	Price (€)
0,74	0,15	2,00	80	000186	18,70
1,10	0,15	2,50	80	000184	19,00
1,50	0,15	3,00	80	000071	19,60
2,00	0,15	4,50	80	000070	20,80
2,50	0,15	5,50	80	000069	22,80
3,00	0,15	6,50	80	000066	24,20
4,00	0,15	10,00	80	000183	66,90



END TOE BOARD METRIC - UNI



- Timber
- Galvanized steel fittings
- To complete the three-part side protection in the frontside in conjunction with UNI decks

Length (m)	Height (m)	Weight (kg)	PU (pcs.)	Article no.	Price (€)
0,74	0,15	1,50	100	005852	20,30
1,10	0,15	1,90	100	005853	22,60
1,50	0,15	2,50	80	005854	24,20
2,00	0,15	4,50	80	005855	27,40
2,50	0,15	5,50	80	005856	29,10
3,00	0,15	6,50	80	005857	29,80



END TOE BOARD FOR TWO TOE BOARD BOLTS 0,74 M



- Timber
- Galvanized steel fittings
- To complete side protection in the frontside
- In conjunction with deck fastener 0.74 m, U-clamp, 2 x toe board bolt
- (Art.-No. 013405) or deck fastener UN-support 0,74 m (Art.-No. 005677)

Length (m)	Height (m)	Weight (kg)	PU (pcs.)	Article no.	Price (€)
0,74	0,15	1,50	-	013962	20,30



END TOE BOARD FOR TWO TOE BOARD BOLTS 1,00 M



- Timber
- Galvanized steel fittings
- To complete side protection in the frontside
- In conjunction with deck fastener 1.10 m, U-clamp, 2 x toe board bolt
- (Art.-No. 013821) or deck fastener UN-support 1,10 m (Art.-No. 005678)

Length (m)	Height (m)	Weight (kg)	PU (pcs.)	Article no.	Price (€)
1,10	0,15	1,90	-	013963	22,60



INDIVIDUAL COLOR AND PRINT ON REQUEST

TOE BOARD BRACKET



- Steel, hot dip galvanized
- With wedge head connection
- May only be used in conjunction with UNI toe board

Weight (kg)	Article no.	Price (€)
0,60	005732	17,30



BRACKET TUBE-SUPPORT METRIC



- Steel, hot dip galvanized
- Without tube connector
- With two wedge heads connections
- To extend scaffold inwards or outwards



Width (m)	Weight (kg)	PU (pcs.)	Article no.	Price (€)
0,41	3,50	100	005741	49,30
0,50	3,80	100	005742	49,30
0,75	6,00	20	004822	61,10

BRACKET LEDGER TUBE SUPPORT



- Steel, hot dip galvanized
- With one wedge head connection
- To support the steel deck for tube support in the width 0.24 m or 0.32 m



Width (m)	Weight (kg)	Article no.	Price (€)
0,29	1,50	005743	21,80
0,36	1,70	005744	22,80

BRACKET UN-SUPPORT



- Steel, hot dip galvanized
- With wedge head connection
- Without strut
- Without tube connector



Model	Width (m)	Weight (kg)	PU (pcs.)	Article no.	Price (€)
UNI/UT	0,15	1,20	25	011644	43,00
UNI	0,32	1,50	25	011642	47,80
UT	0,29	1,80	25	013167	44,80

BRACKET SUPPORT METRIC - UNI



- Steel, hot dip galvanized
- Without tube connector
- With two wedge head connections
- To extend scaffold inwards or outwards with serial UNI decks



Model	Width (m)	Weight (kg)	PU (pcs.)	Price (€)	Preis (€)
1-board	0,41	3,30	100	004520	51,20
2-board	0,74	5,90	20	004521	67,60

BRACKET UN-SUPPORT WITH TUBE CONNECTOR 1-BOARD



- Steel, hot dip galvanized
- With tube connector
- With wedge head connection



Model	Width (m)	Weight (kg)	PU (pcs.)	Article no.	Price (€)
1-board	0,39	4,4	20	013076	53,80

BRACKET UN-SUPPORT WITH TUBE CONNECTOR 2-BOARD



- Steel, hot dip galvanized
- With tube connector
- With wedge head connection



Model	Width (m)	Weight (kg)	PU (pcs.)	Article no.	Price (€)
2-board	0,74	6,3	20	013077	70,60

BRACKET UT-SUPPORT WITH TUBE CONNECTOR



- Steel, hot dip galvanized
- With tube connector
- With wedge head connection



Model	Weight (kg)	PU (pcs.)	Article no.	Price (€)
1-board	4,60	26	013168	53,70

BRACKET UT-SUPPORT WITH TUBE CONNECTOR



- Steel, hot dip galvanized
- With tube connector
- With wedge head connection



Model	Weight (kg)	PU (pcs.)	Article no.	Price (€)
2-board	6,60	26	013169	71,00

STANDARD COUPLER

EN

- Steel, hot dip galvanized, drop-forged
- Robust model
- For right-angled connection of tubes of \varnothing 48.3 mm
- Class BB, EN 74-1
- To be used in the classes B and BB of the steel and aluminum tube

Thread	A/F	Weight (kg)	PU (pcs.)	Article no.	Price (€)
Standard	22	1,15	25	000325	8,60
Standard	19	1,15	25	000326	8,60
Quick	22	1,15	25	007521	9,30
Quick	19	1,15	25	007523	9,30



SWIVEL COUPLER

EN

- Steel, hot dip galvanized, drop-forged
- Robust model
- For any angular connection of tubes of \varnothing 48.3 mm
- Class B, EN 74-1
- To be used in the class B of the steel and aluminum tube

Thread	A/F	Weight (kg)	PU (pcs.)	Article no.	Price (€)
Standard	22	1,35	25	000328	9,30
Standard	19	1,35	25	000329	9,30
Quick	22	1,35	25	007522	9,90
Quick	19	1,35	25	007524	9,90



SPARE PARTS CAN BE FOUND IN OUR PRICE LIST „ACCESSORIES“.

SCAFFOLD TUBE STEEL

EN

- S235 Steel, hot dip galvanized
- Measurements as per EN 39
- Manufacturing length 6.00 m
- Minimum yield strength 235 N/mm²
- Connection of standard couplers allowed
- Special lengths on request

Model (mm)	Length (m)	Weight (kg)	PU (pcs.)	Article no.	Price (€)
48,3 x 3,2	1,00	3,77	61	004548	17,20
48,3 x 3,2	2,00	7,54	61	004550	31,40
48,3 x 3,2	3,00	11,31	61	004552	45,60
48,3 x 3,2	4,00	15,08	61	004554	61,80
48,3 x 3,2	5,00	18,85	61	005619	76,00
48,3 x 3,2	6,00	22,60	61	004087	85,00

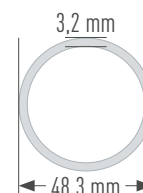

WEDGE HEAD COUPLER FIXED EN

- Steel, hot dip galvanized, drop-forged
- With screw cap
- For connection of scaffold tubes to the perforated disc



A/F	Weight (kg)	PU (pcs.)	Article no.	Price (€)
22	1,10	25	005859	25,70
19	1,10	25	005858	25,70

SVIWEL WEDGE HEAD COUPLER EN

- Steel, hot dip galvanized, drop-forged
- With screw cap
- For connection of scaffold tubes to the perforated disc



A/F	Weight (kg)	PU (pcs.)	Article no.	Price (€)
22	1,20	25	005861	28,90
19	1,20	25	005860	28,90

WEDGE HEAD COUPLER FIXED PARALELL EN

- Steel, hot dip galvanized, drop-forged
- For connection of scaffold tubes to the perforated disc



A/F	Weight (kg)	PU (pcs.)	Article no.	Price (€)
19	1,10	25	009947	24,20
22	1,10	25	009948	24,20

WEDGE HEAD COUPLER DOUBLE

- Steel, hot dip galvanized

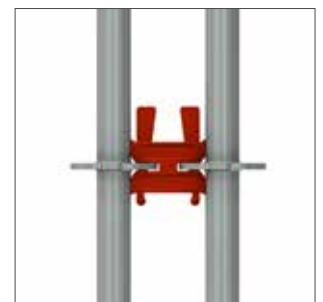

Width (m)	Weight (kg)	Article no.	Price (€)
0,15	1,20	011125	25,70

DISTANCE COUPLER

- Steel tube \varnothing 48.3 mm
- With two welded couplers, galvanized
- E. g. as connection between facade scaffold and a forward-placed stair ascent

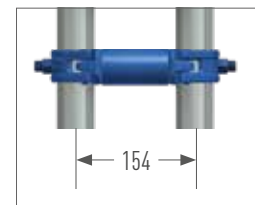

Width (m)	A/F	Weight (kg)	Article no.	Price (€)
0,110	22	1,60	008225	26,00
0,154	19	1,80	008297	26,30
0,180	22	2,00	000233	27,10

PEFORATED DISC CLAMPABLE

- Ensures the possibility of mounting at the desired position along a standards or tubes \varnothing 48.3 mm



A/F	Weight (kg)	PU (pcs.)	Article no.	Price (€)
22	1,00	25	002229	36,70
19	1,00	25	004587	36,70

**MORE COUPLERS
FIND IN OUR PRICE LIST
'ACCESSORIES'**

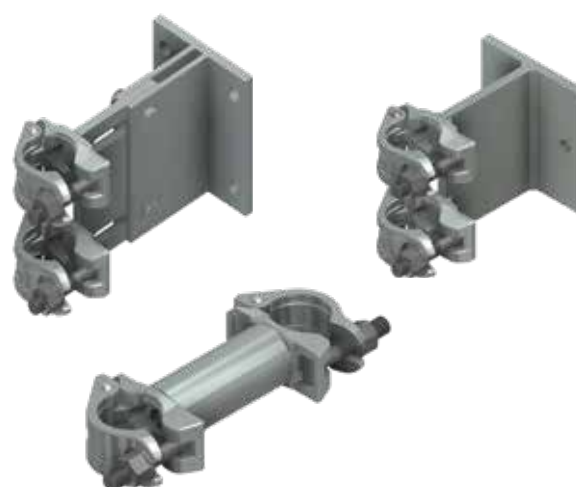

EYE BOLT Ø 12 MM  

- Galvanized and welded
- For use with plastic expansion plugs 70/100 mm and plastic caps natural / black

Length (m)	Thread Length (mm)	Weight (kg)	PU (pcs.)	Article no.	Price (€)
90	54	0,155	150	000358	1,50
120	65	0,175	150	000359	1,70
160	58	0,210	100	000360	1,90
190	65	0,235	100	000363	2,10
230	65	0,265	100	000361	2,20
300	65	0,300	50	002374	2,50
350	65	0,364	50	000362	2,70
400	65	0,424	50	006333	6,00
450	65	0,468	50	007555	6,20
500	65	0,530	50	002983	7,50



EYE BOLT M12  

- Galvanized and welded
- With metric thread

Length (m)	Thread Length (mm)	Weight (kg)	PU (pcs.)	Article no.	Price (€)
60	35	0,140	150	012379	5,00
80	35	0,150	150	012383	5,10
100	35	0,160	100	012384	5,20
120	35	0,175	100	012385	5,40
160	35	0,210	100	012386	5,60
220	35	0,260	50	012387	5,90



PLASTIC CAP  

- For closing anchor drill holes

Colour	Weight (kg)	PU (pcs.)	Article no.	Price (€)
natural	0,003	100	000651	0,20
black	0,003	100	010353	0,20



EXPANSION PLUG  

- For eye bolts with a timber thread Ø 12 mm
- For drilling Ø 14 mm

Length (m)	Weight (kg)	PU (pcs.)	Article no.	Price (€)
0,07	0,007	100	000357	0,40
0,10	0,007	100	011158	0,40



MJ-SCAFFY 

- Screw-in aid for eye bolts
- With socket A/F 22 (for standard ratchet wrenches)
- With 3/4 inch square socket
- With SDS drill adapter



Weight (kg)	Article no.	Price (€)
0,374	012600	70,60

The system free safety enclosure OPTI-BOARD is the answer to many questions that you may ask yourself when planning your construction site with regard to environmental and noise protection. When renovating or building a new building, the construction site enclosure protects employees and passers by from noise, dust and dirt.

- Light cassette: The transparent version of the OPTI-BOARD enables work in daylight conditions.
- Dust-tight: A circumferential rubber seal makes the OPTI-BOARD almost dust-tight. This enables a clean construction site cladding, the use of vacuum systems (asbestos removal) and weather-independent sandblasting.
- Quick and easy assembly
- Can be use in the UNI, UNI-CONNECT, UNI TOP, COMBI and OPTIMA systems
- Can be installed vertically and horizontally

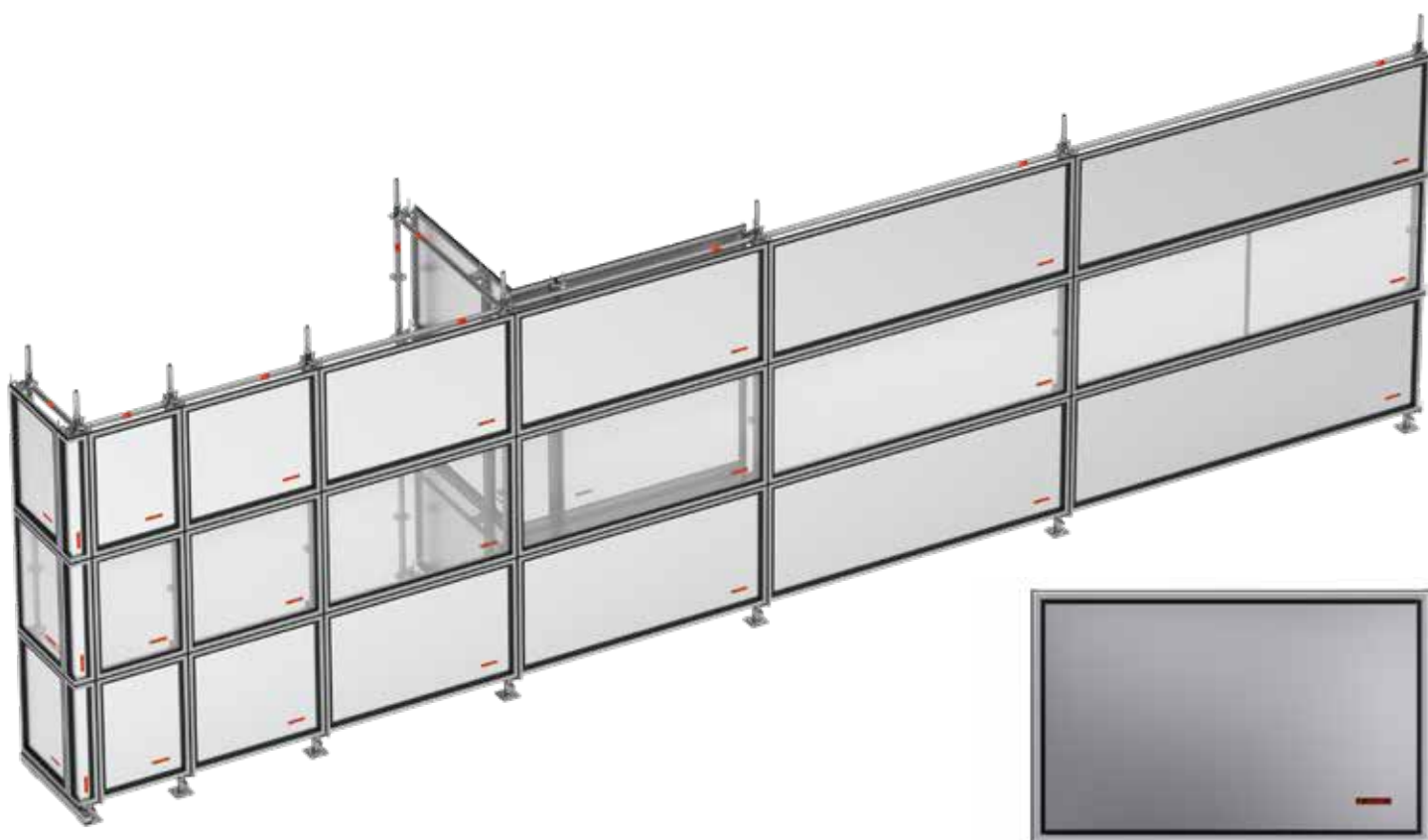

WALLCASSETTE SHEET METRIC



Width	Height	Weight (kg)	PU (St.)	Article-no.	Price (€)
0,50	1,00	5,50	14	012064	172,50
0,65	1,00	6,10	14	012880	170,50
1,00	1,00	8,70	14	012065	198,50
1,10	1,00	9,00	14	012890	191,30
1,50	1,00	12,00	14	012066	229,70
2,00	1,00	15,25	14	012067	273,20
2,50	1,00	18,50	14	012068	301,20
3,00	1,00	22,50	14	012069	351,90



WALLCASSETTE LIGHT METRIC 

Width	Height	Weight (kg)	PU (St.)	Article-no.	Price (€)
0,50	1,00	4,30	14	012070	189,70
0,65	1,00	4,70	14	012885	345,70
1,00	1,00	6,45	14	012071	224,80
1,10	1,00	6,60	14	012895	216,70
1,50	1,00	8,60	14	012072	301,50
2,00	1,00	10,70	14	012073	351,60
2,50	1,00	12,80	14	012074	419,40
3,00	1,00	15,40	14	012075	459,40

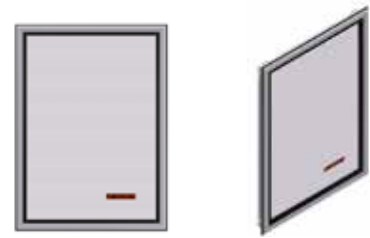

INSIDE CORNER FOR WALLCASSETTE 

Width	Height	Weight (kg)
0,40	1,00	6,85
PU (St.)	Article-no.	Price (€)
20	012088	206,10



OUTSIDE CORNER FOR WALLCASSETTE 

Width	Height	Weight (kg)
0,17	1,00	3,90
PU (St.)	Article-no.	Price (€)
50	012089	172,80



CASSETTE HOLDER 

System	Weight (kg)	PU (St.)	Article-no.	Price (€)
MODULE	1,00	250	012060	29,40
LEDGER	1,30	250	012061	33,40
TUBE	0,85	300	012062	33,40



012060



012061



012062



STACKING PALLET FOR TUBES



- Steel tube, hot-dip galvanized
- Specially suited for module scaffolds, e. g. standards, ledgers, guard rails, diagonal braces, tubes and toe boards
- Open all round
- Suited for stacked and crane transports
- The tubular supports are removable and are to be stowed securely in the base frame so that empty pallets can be transported and stacked in a very space-saving manner
- Special orders on request
- Push-on tube with bevel on one side, also available separately (Article no. 005791)

Length (m)	Width (m)	Weight (kg)	PU (pcs.)	Article no.	Price (€)
0,85	0,85	30,50	5	006962	232,20
1,25	0,55	31,80	5	010334	231,90
1,25	0,85	35,00	5	005614	240,20
1,50	1,05	56,50	-	012209	399,00



YOU CAN FIND ADDITIONAL PRODUCTS FOR STORAGE AND TRANSPORT IN OUR PRICE LIST 'ACCESSORIES'



GUARD RAIL LEDGER

- Rectangular tube, hot dip galvanized
- With hook and wedge head connection for hanging in the perforated disc
- Confusion and misuse due to rectangular tube excluded
- No subsequent installation or removal possible in the form of hooks / hooks
- Reduced transport volume, lower weight

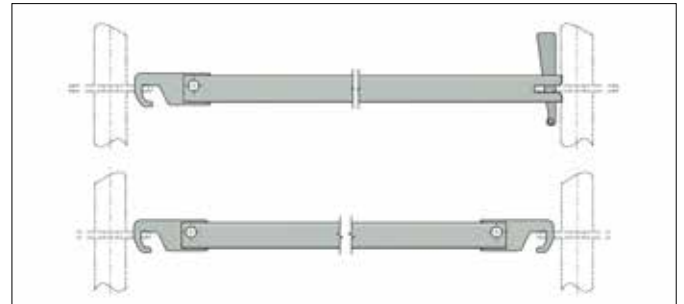

Model	Field length (m)	Weight (kg)	PU (pcs.)	Article no.	Price (€)
CO Guard rail ledger hook / wedge	1,50	3,00	50	012466	48,50
CO Guard rail ledger hook / wedge	2,00	4,30	50	012467	49,90
CO Guard rail ledger hook / wedge	2,50	6,60	50	012468	55,00
CO Guard rail ledger hook / wedge	3,00	7,90	50	012469	56,20
CO Guard rail ledger hook / hook	1,50	2,90	50	012470	35,50
CO Guard rail ledger hook / hook	2,00	4,20	50	012474	36,90
CO Guard rail ledger hook / hook	2,50	6,50	50	012475	43,00
CO Guard rail ledger hook / hook	3,00	7,80	50	012476	50,30

Assembly sequence

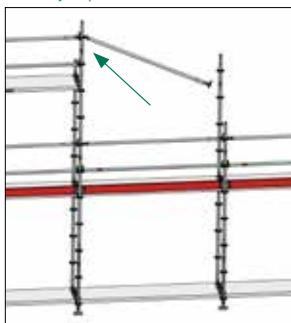

Guard rail ledger at the top with the hook side hang on the perforated disc at +3.00 m

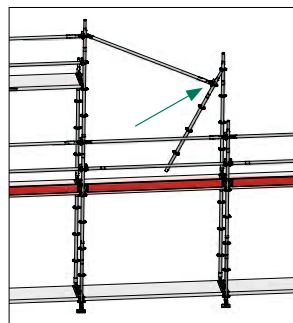

Vertical standard attach to the free ledger side

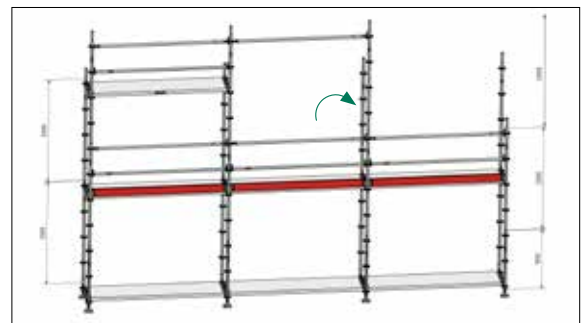

Vertical standard with guard rail ledger put on

SET - PERSONAL PROTECTIVE EQUIPMENT MILLER 1

EN N



- Revolution R2 Comfort harness – with 80 cm back eyelet extension (EN 361), elastic dura flex belt band, sharp edge tested, front and rear eyelet, comfort back pads, automatic fasteners for quick on and off, belt end clips, swivel connection at waist height for optimal ergonomics when bending or stretching, attachment point for tools and accessories, integrated label tray
- Lifetime of the material is 10 years
- Lanyards with shock absorber - length 2.00 m, sharp edges tested, horizontally approved (attachment point on foot level), 63 mm scaffold hook, stretchy design for more latitude of movement, safety clip for fastening to harness, Teflon-coated for longer life, EN 354 and EN 355
- Equipment bag - 0.27 x 0.80 m (D x H), made of PVC, red



Size	Article no.	Price (€)
S - M	006273	280,00
L - XL	005610	280,00

SET - PERSONAL PROTECTIVE EQUIPMENT MILLER 2

EN N



- Revolution R2 Comfort harness – with 80 cm back eyelet extension (EN 361), elastic dura flex belt band, sharp edge tested, front and rear eyelet, comfort back pads, automatic fasteners for quick on and off, belt end clips, swivel connection at waist height for optimal ergonomics when bending or stretching, attachment point for tools and accessories, integrated label tray
- Twin Manyard EDGE 2.00 m - with 2 x 63 mm aluminum hooks (EN 354 + 355), sharp edges tested, integrated shock absorber with fall of indicator
- Lifetime of the material is 10 years
- Equipment bag - 0.27 x 0.80 m (D x H), made of PVC, red



Size	Article no.	Price (€)
L - XL	011284	410,00

ALL SET COMPONENTS MAY ALSO BE ORDERED SEPARATELY

KASK INDUSTRIAL CLIMBING HELMET PLASMA Q

EN ID N

- Tested and approved according to EN 397
- With chin strap
- Adjusting wheels allow one quick and easy adjustment to the right size
- With ring for attaching the helmet to a belt

Color	Article no.	Price (€)
blue	010496	74,60
white	010497	74,60
yellow	010498	74,60
orange	010499	74,60
red	010500	74,60
green	010501	74,60
dark green	010502	74,60
royal blue	010503	74,60
black	010453	74,60



KASK INDUSTRIAL CLIMBING HELMET ZENITH

EN ID N

- Tested and approved according to EN 397 and EN 50365
- Various settings allow a quick and easy adjust
- With ring for attaching the helmet to a belt

Color	Article no.	Price (€)
blue	010504	71,50
white	010505	71,50
yellow	010506	71,50
orange	010507	71,50
red	010508	71,50
green	010509	71,50
black	010510	71,50



OTHER PROTECTIVE EQUIPMENT FIND IN OUR PRICELIST 'ACCESSORIES'

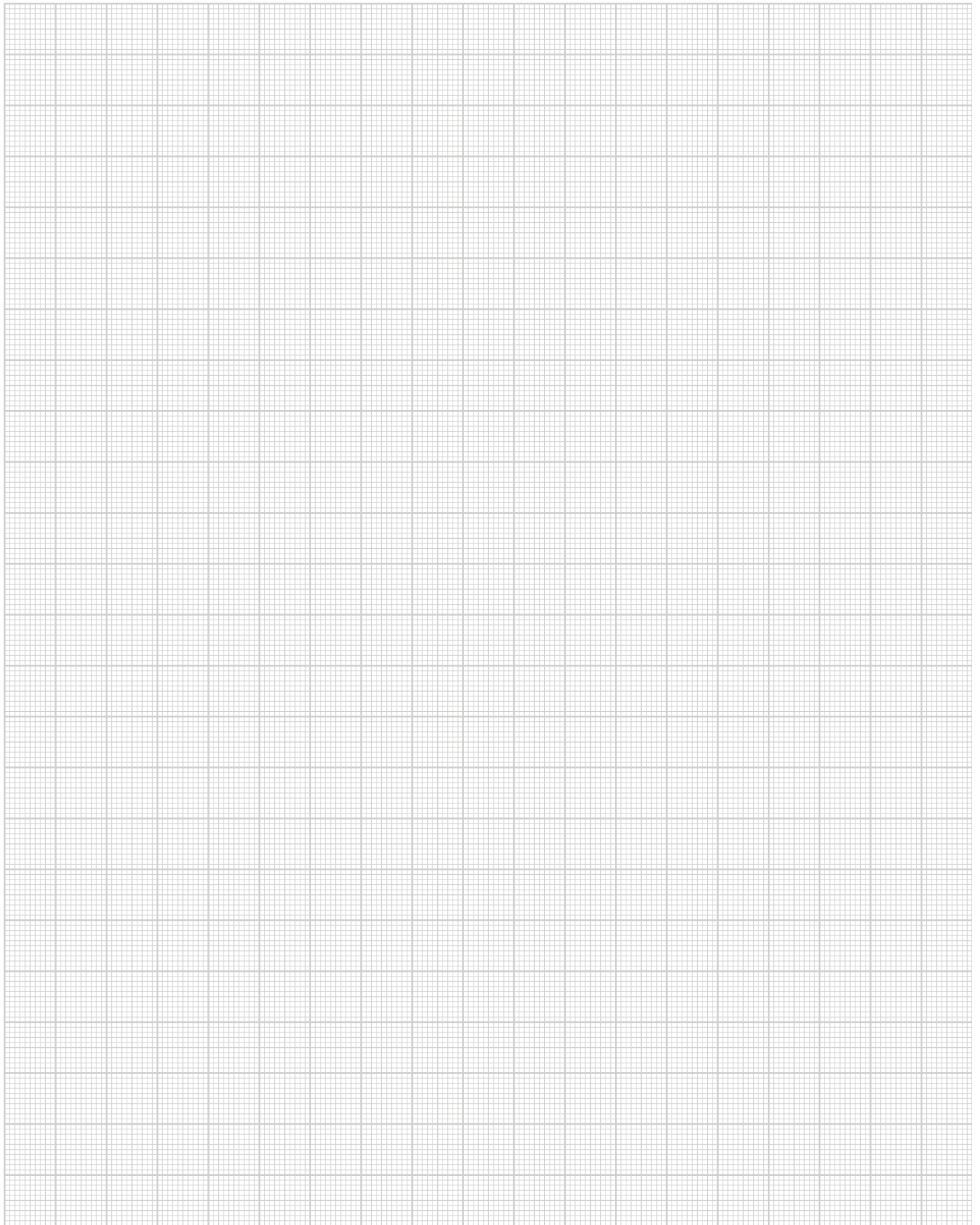

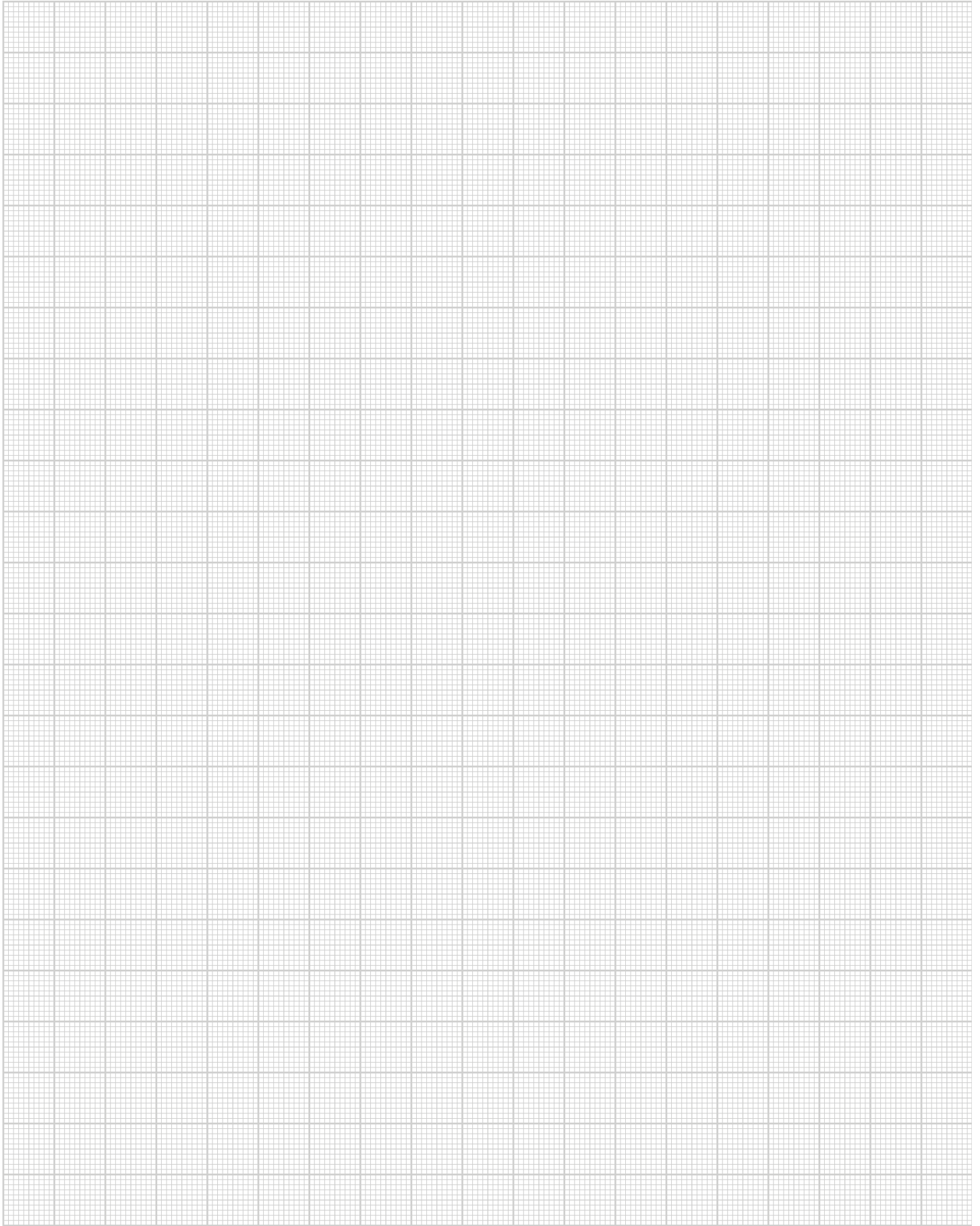



SIMPLY FILL OUT THE FORM AND SEND TO
 Fax: +49 2391 8105 375 or E-mail: info@mj-geruest.de

<hr/> Company	<hr/> Customer no.
<hr/> Street	<hr/> Phone
<hr/> Postal code, city, country	<hr/> Fax
<hr/> Name of buyer	<hr/> E-mail

ORDER **INQUIRY**

Order/Quotation please send by post by fax by e-mail

PRODUCT DESCRIPTION	ARTICLE NO.	QUANTITY	UNIT PRICE €	TOTAL VALUE €

ORDER VALUE €

All prices exclude VAT applicable at the time of shipment. All dimensions and weights are non-binding approximate values. Technical data is subject to change without prior notice. Prices are charged as applicable on the day of shipment. Sale is subject exclusively to our sales terms and delivery conditions. In brief: place of business and jurisdiction is Plettenberg. Extended reservation of property rights until full payment of all our outstanding accounts are recieved. Our prices are ex work.

<hr/> Date of delivery	<hr/> Shipping method	
<hr/> Delivery address:	<hr/> Freight costs	
<hr/>	<hr/> Terms of delivery	
<hr/>	<hr/> Terms of payment	<hr/> Stamp/Signature
<hr/>	<hr/> MJ-Consultant	<hr/> Date



MJ-GERÜST

Scaffolding Systems

SCAFFOLDING MADE IN
PLETTENBERG

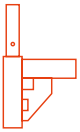

UNI-CONNECT

07er Frame scaffold

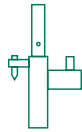

UNI

Metric frame scaffold

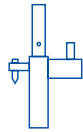

UNI TOP

Metric frame scaffold

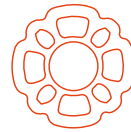

COMBI

Modular scaffold

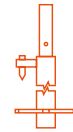

OPTIMA

Flexible façade scaffolding

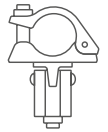

ACCESSORIES

Universal

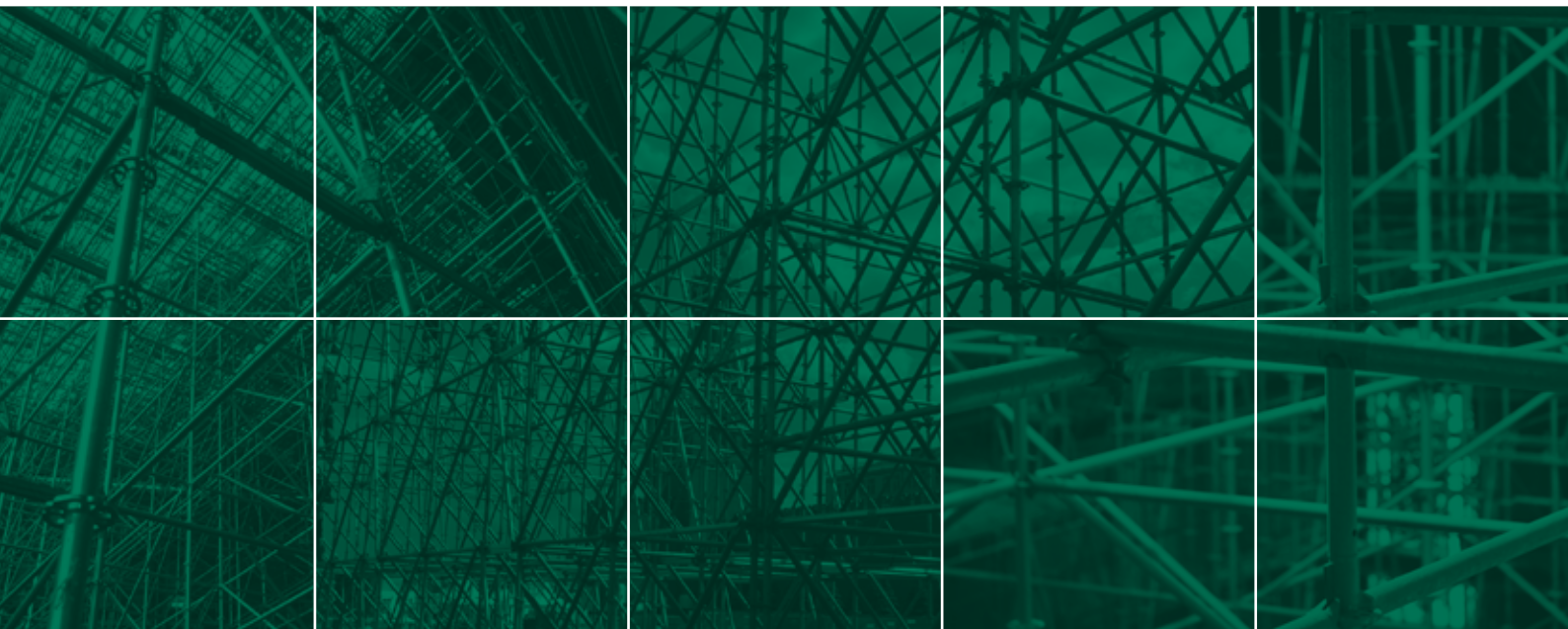

[WWW.GERUESTLAGER.DE](http://www.geruestlager.de)

MJ-Gerüst GmbH

Ziegelstraße 68
58840 Plettenberg
Germany

Hotline +49 2391 8105 350

Fax +49 2391 8105 375

E-mail info@mj-geruest.de

www.mj-geruest.de